



SOFTWARE VERSION 3.6

[WWW.PRG.COM](http://WWW.PRG.COM)

# VX76 SOFTWARE

## USER MANUAL

AutoPar®, Bad Boy®, Best Boy 4000®, PRG Series 400®, MBOX®, MBOX Extreme®, OHM™, Super Node™, V476®, V676®, Virtuoso®, Virtuoso® DX, Virtuoso® DX2, and VL6C+™ are trademarks of Production Resource Group, LLC, registered in the U.S. and other countries.

Mac®, QuickTime® and FireWire® are registered trademarks of Apple Computer, Inc.

All other brand names which may be mentioned in this manual are trademarks or registered trademarks of their respective companies.

This manual is for informational use only and is subject to change without notice. Please check [www.prg.com](http://www.prg.com) for the latest version. PRG assumes no responsibility or liability for any claims resulting from errors or inaccuracies that may appear in this manual.

Vx76 Software User Manual

Version as of: March 22, 2013

PRG part number: 02.9814.0001.36

Production Resource Group, LLC  
Dallas Office  
8617 Ambassador Row, Suite 120  
Dallas, Texas 75247  
[www.prg.com](http://www.prg.com)

## FOREWORD

---

### End User Software License

PLEASE READ THIS DOCUMENT CAREFULLY BEFORE ACTIVATING, COPYING, INSTALLING, OR USING THIS SOFTWARE PROVIDED BY PRODUCTION RESOURCE GROUP, LLC. BY ACTIVATING, COPYING, INSTALLING, OR USING THIS SOFTWARE, YOU ARE AGREEING TO BE BOUND BY THE TERMS OF THIS LICENSE. IF YOU DO NOT AGREE TO THE TERMS OF THIS LICENSE, DO NOT ACTIVATE, COPY, INSTALL, OR USE THIS SOFTWARE AND PROMPTLY RETURN IT FOR A REFUND.

- 1) License. Production Resource Group, LLC. ("PRG") hereby grants you a limited license to install and use the Vx76 software and related documentation (collectively, the "Software") solely with the console sold in conjunction with the Software. PRG retains all right, title and interest to the Software which is protected by various proprietary rights, including but not limited to copyrights, trade secrets, or patents ("Proprietary Rights"). No license, right or interest in any trademark, trade name or service mark of PRG or any third party is granted under this License.
- 2) No Implied License. You acknowledge that this License in no way shall be construed to provide an implied license to use, modify or improve any of PRG's patented technology, copyrights, trade secrets, trademarks, and/or other Proprietary Rights.
- 3) Restrictions. The Software contains proprietary information that is possibly protected by a combination of patent, copyright, trade secret, and/or other Proprietary Rights, and constitutes valuable property of PRG. You acknowledge that the Software is disclosed in circumstances of confidence and only for use by you under the terms and conditions of this License and that you do not acquire any rights of ownership or title in the Software. You may not attempt to create or derive source codes by disassembly, reverse engineering or any other method, or otherwise reduce the Software to a human-perceivable form. You may not modify or translate any part of the Software. You may not use, disclose, distribute, make or have made any copies of the Software, in whole or in part, without the prior written authorization of PRG. You agree to make reasonable efforts to notify and inform your employees or agents having access to the Software of your limitations, duties and obligations regarding non-disclosure and copying of the Software. The Software shall be used only by you, your employees or your authorized agents. You agree to provide notice to PRG immediately after learning of or having reason to suspect a breach of any of the restrictions set forth in this License.
- 4) Termination. This License is effective until terminated. You may terminate this License at any time by destroying the Software, and all copies thereof. This License will terminate immediately without notice from PRG if you fail to comply with any provision of this License. Upon termination, you must destroy the Software and all copies thereof.
- 5) Export Control Requirements. This License, and any technical information supplied during the term of this License, is made subject to any restrictions concerning the export of products or technical data from the United States of America which may be imposed upon PRG or you from time to time by the Government of the United States of America. Furthermore, you agree that at no time, either during the term of this License or thereafter, will you knowingly export, directly or indirectly, any United States source technical data acquired from PRG under this License or any direct products of that technical data to any country for which the U.S. Government or any agency thereof at the time of export requires an export license or other governmental approval, without first obtaining that license or approval when required by applicable United States law.
- 6) Limited Warranty. PRG warrants the media on which the Software is recorded to be free from defects in materials and workmanship under normal use for a period of ninety (90) days from the date of purchase as evidenced by a copy of your receipt. PRG's entire liability and your exclusive remedy will be replacement of a media that does not meet PRG's limited warranty and is returned at your expense, along with a copy of your receipt, to PRG customer support or to PRG's authorized representative. If replacement of the media is not reasonably practical or commercially reasonable as determined solely in the discretion of PRG, PRG will refund the purchase price as evidenced by a purchase receipt. PRG will have no responsibility to replace media damaged by accident, abuse or misapplication. EXCEPT FOR THE FOREGOING, THE SOFTWARE AND RELATED DOCUMENTATION ARE PROVIDED "AS IS," WITHOUT ADDITIONAL WARRANTY OF ANY KIND, AND PRG EXPRESSLY DISCLAIMS ALL OTHER WARRANTIES, EXPRESS OR IMPLIED, INCLUDING, BUT NOT LIMITED TO, THE IMPLIED WARRANTIES OF DESIGN, MERCHANTABILITY, FITNESS FOR A PARTICULAR PURPOSE, OR TITLE, ANY



WARRANTIES ARISING FROM A COURSE OF DEALING, USAGE, OR TRADE PRACTICE, OR ANY WARRANTIES OF NON-INFRINGEMENT OF ANY THIRD PARTY'S PATENT(S), TRADE SECRET(S), COPYRIGHT(S) OR OTHER INTELLECTUAL PROPERTY RIGHTS. PRG DOES NOT WARRANT THAT THE FUNCTIONS CONTAINED IN THE SOFTWARE WILL MEET YOUR REQUIREMENTS, OR THAT THE OPERATION OF THE SOFTWARE WILL BE UNINTERRUPTED OR ERROR-FREE, OR THAT DEFECTS IN THE SOFTWARE WILL BE CORRECTED. FURTHERMORE, PRG DOES NOT WARRANT OR MAKE ANY REPRESENTATIONS REGARDING THE USE OR THE RESULTS OF THE USE OF THE SOFTWARE OR RELATED DOCUMENTATION IN TERMS OF THEIR CORRECTNESS, ACCURACY, RELIABILITY, OR OTHERWISE. NO ORAL OR WRITTEN INFORMATION OR ADVICE GIVEN BY PRG OR ITS AUTHORIZED REPRESENTATIVE SHALL CREATE ANY WARRANTY OR IN ANY WAY INCREASE THE SCOPE OF THIS WARRANTY. SHOULD THE SOFTWARE PROVE DEFECTIVE, YOU (AND NOT PRG OR ITS AUTHORIZED REPRESENTATIVE) ASSUME THE ENTIRE COST OF ALL NECESSARY SERVICING, REPAIR OR CORRECTION. SOME STATES DO NOT ALLOW EXCLUSION OF IMPLIED WARRANTIES, SO THE ABOVE EXCLUSION MAY NOT APPLY TO YOU. THIS WARRANTY GIVES YOU SPECIFIC LEGAL RIGHTS, AND YOU MAY ALSO HAVE OTHER RIGHTS WHICH VARY FROM STATE TO STATE.

- 7) Limitation Of Liability. UNDER NO CIRCUMSTANCES, INCLUDING NEGLIGENCE, SHALL PRG BE LIABLE FOR ANY LOST REVENUE OR PROFITS OR ANY INCIDENTAL, INDIRECT, SPECIAL, OR CONSEQUENTIAL DAMAGES THAT RESULT FROM THE USE OR INABILITY TO USE THE SOFTWARE OR RELATED DOCUMENTATION, EVEN IF PRG OR ITS AUTHORIZED REPRESENTATIVE HAS BEEN ADVISED OF THE POSSIBILITY OF SUCH DAMAGES. SOME STATES DO NOT ALLOW THE LIMITATION OR EXCLUSION OF LIABILITY FOR INCIDENTAL OR CONSEQUENTIAL DAMAGES SO THE ABOVE LIMITATION OR EXCLUSION MAY NOT APPLY TO YOU. IN NO EVENT SHALL PRG'S TOTAL LIABILITY TO YOU FOR ALL DAMAGES, LOSSES, AND CAUSES OF ACTION, WHETHER IN CONTRACT, TORT (INCLUDING NEGLIGENCE) OR OTHERWISE, EXCEED THE AMOUNT PAID BY YOU FOR THE SOFTWARE.
- 8) Arbitration, Jurisdiction, and Venue. You agree that any action at law or in equity arising out of the License or relating to this Software shall be resolved, individually, through binding arbitration using the then current rules of the American Arbitration Association, in Dallas, Texas and the resulting decisions may be entered in any court with proper jurisdiction. This means that if you have a grievance with us, you cannot take us to court, and you may not join your action with any other party. You can address such grievances through arbitration only and you are hereby consenting to do it in Dallas, Texas, using Texas' laws (without regard to Texas' conflicts of laws). You agree that are properly subject to the jurisdiction of the courts of the State of Texas and waive any rights to challenge personal jurisdiction.
- 9) Government Licensee. If you are acquiring the Software on behalf of any unit or agency of the United States Government, the following provisions apply: (a) the Government acknowledges PRG's representation that the Software and its documentation were developed at private expense and no part of them is in the public domain; (b) the Government acknowledges PRG's representation that the Software is "Restricted Computer Software" as that term is defined in Clause 52.227-19 of the Federal Acquisition Regulations ("FAR") and is "Commercial Computer Software" as that term is defined in Subpart 227.471 of the Department of Defense Federal Acquisition Regulation Supplement ("DFARS"). The Government agrees that: (i) if the Software is supplied to the Department of Defense ("DoD"), the Software is classified as "Commercial Computer Software" and the Government is acquiring only "limited rights" in the Software and its documentation as that term is defined in Clause 252.227-7013(a)(13) of the DFARS, and (ii) if the Software is supplied to any unit or agency of the United States Government other than DoD, the Government's rights in the Software and its documentation will be as defined in Clause 52.227-19(c)(2) of the FAR.
- 10) Indemnity. You agree to indemnify and hold harmless PRG, and its parents, subsidiaries, affiliates, officers, directors, shareholders, employees and agents, from and against any costs, losses, liabilities and expenses, including reasonable attorney's fees, that PRG may suffer, incur, or be subjected to by reason of any claim by a third party due to or arising out of your conduct, your use of the Software, any alleged breach of this License or the representations and warranties herein, the alleged violation of the rights of any third party, or any alleged infringement of the intellectual property rights of any third party, including but not limited to your use of any content, trademarks, service marks, trade names or other intellectual property used in connection with the Software. PRG reserves the right to control the exclusive defense of any matter otherwise subject to your indemnification, which will not excuse your indemnity obligations.



## Revision History

This manual has been revised as follows:

Version	Release Date	Notes
BASIC.1	April 23, 2010	Software version 1.0. Initial release.
BASIC.2	October 14, 2010	Updated book format. (No changes to technical information.)
.11	November 5, 2010	Updated to software version 1.1.
.20	April 4, 2011	Updated to software version 2.0.
.25	September 14, 2011	Updated to software version 2.5. Added V476 console. Added "Palette Store Dynamic Only" instructions to Dynamics chapter.
.30	March 28, 2012	Updated to software version 3.0. Added new information and instructions to Dynamics chapter.
.35	November 30, 2012	Updated to software version 3.5. Added new CITP information to Media Server section.
.36	March 22, 2013	Revised manual (Overview, Installation, and Specification sections) to remove hardware information for V476 and V676 consoles. Added applicable info for V276 On Mac console. This manual now applies to Vx76 software operation only.



## Notes

# TABLE OF CONTENTS

---

## Introduction

About This Manual.....	1
Products Covered.....	1
Additional Documentation.....	1
Training Videos.....	2
Customer Service.....	2
Obtaining Additional DMX Profiles.....	3
Text Conventions and Icons.....	3

## Chapter 1. General Operation

### General Operation

About Vx76 Software.....	6
Power Up Console and Launch Vx76 Application.....	6
Restart Front Panel (V476/V676 Only).....	6
Restart Vx76 Application.....	7
Power Down Console (V476/V676 Only).....	7
Power Down Console (V276 On Mac Only).....	7
Window Operation.....	8
Status Indicator Bar.....	9

### Setting Preferences

Brightness Level (V476/V676 Only).....	11
For Front Panel and Monitors.....	11
For Keyboard.....	11

### Important Notes Regarding Different Types of Vx76 Consoles

Special Features to Accommodate the V476 Front Panel.....	12
Workspace Swapping.....	13
Special Considerations for the V276 On Mac.....	14

### Show Files

About Show Files.....	16
Utilities Screen.....	16
Show File Manager Window.....	17

## Chapter 2. Configuration and Patch

### System Configuration

System Configuration Overview.....	20
Using System Configuration.....	21
Naming a Console.....	21
Store/Clear Configuration.....	22
Error Messages.....	22
Clear Errors / Reset Node.....	23
Update Configuration.....	23
Ethernet Configuration.....	24
Device Pairing.....	25

### Patch

Patch Overview.....	26
Profiles.....	26
DMX Universes.....	27
Streaming ACN.....	27
Patch Procedures.....	28
Enabling/Disabling Patch Editing.....	28
Patching DMX Fixtures.....	29
Entering Patch Commands.....	30
Patching Multi-Channels - Conventionals and Scrollers.....	30
LED Fixture Control.....	31

Patching Ranges .....	31
Patch Editing .....	32
Using Command Line.....	32
Using Patch Spreadsheet.....	32
Using Plan View.....	32
Patch Spreadsheet.....	33
Dimmer Curves.....	35
Overview.....	35
Dimmer Curves Window.....	35
<b>Plan View</b>	
General Plan View Operation.....	37
Selecting Channels.....	37
Zoom .....	38
Pan .....	39
Nudge and Align.....	39
Plan View Settings.....	40
Plan View Layouts.....	41
2D/3D Layouts.....	41
Custom Layouts .....	41
Plan View Actions (Show/Hide) .....	44
Plan View Regions .....	45
Patch Fixtures in Plan View .....	47
Edit Fixture From Plan View.....	47

### Chapter 3. Manual Control

<b>Channel Select</b>	
Overview .....	50
Selecting Channels.....	50
From Channel Select Panel (V476/V676 Only) .....	50
From Channel Select Window.....	53
From Keypad.....	56
[Next] and [Last].....	57

<b>Lamp Control</b>	
Start .....	58
Douse.....	58
Home / Reset (Recalibration).....	59
Erase Luminaire Data.....	59

<b>Encoder Control</b>	
Overview .....	60
Front Panel Encoders .....	61
Value/Range Display .....	63
Pan and Tilt.....	64
Intensity .....	64
Color .....	65
Beam .....	65
Image (Gobo).....	66
3D .....	66
Dynamics.....	67
Frame .....	67
Effect .....	68
Storing New Default Minimum/Maximum Settings (V476/V676 Only).....	68
Sliding Encoder Sidebar (V476 Only).....	69
Encoders HUD Window.....	70
Fan.....	71
High Resolution Mode .....	73

<b>Keypad Control</b>	
Overview .....	74
Setting Parameters From Keypad .....	76
Presets.....	76



Colors .....	76
Beams .....	76
Intensity .....	77
<b>Luminaire Status</b>	
Luminaire Status Window .....	78
Overview .....	78
Manual Change Filter .....	80
Customizing Luminaire Status Window .....	80
Customizing Luminaire Status Toolbar .....	81
Selecting Channels from Luminaire Status Window .....	81
Parameter Columns Window .....	82
Intensity Window .....	83
Configuring How Information is Displayed .....	84
Displaying an Additional Parameter .....	84
Configuring Other Window Options .....	84

## Chapter 4. Timing, Filters and Sneak

### Overview

Timing Filter, Function Filter and Sneak .....	86
General Operations .....	87

### Timing Filter

Overview .....	88
Time/Speed Formats .....	89
Time .....	89
Delay .....	89
Speed .....	89
Timing Filter Operation .....	90
Fanned Timing and Delays .....	92
From Encoder .....	92
From Keypad .....	92

### Function Filter

Overview .....	93
Masking .....	94
Function Filter Operation .....	95

### Sneak

Overview .....	96
Sneak Values .....	97
Sneak Operation .....	98
Sneak 3D .....	99
Sneak Value or Percent .....	100
Direct Sneak To Parameters .....	100

### Templates

Timing/Filter Templates .....	101
Storing and Recalling Templates .....	101

## Chapter 5. Palettes

### General Palette Operation

Overview .....	104
What are Palettes? .....	104
System-Wide Palette Store Options .....	105
Front Panel Palette Displays (V476/V676 Only) .....	106
Desktop Palettes Window .....	108
General Operation .....	109
Palette Labels .....	112
Applying Labels to Palettes .....	112
Soft Keyboard Copy/Paste .....	112
Label Shortcuts .....	113
Century Palette Window .....	114

Submaster Palette Area .....	115
<b>Presets</b>	
Overview .....	116
Storing, Modifying, and Recalling Presets .....	117
From Palettes .....	117
From Keypad .....	119
Preset Global Delete .....	119
Preset Data Window .....	120
<b>Colors</b>	
Overview .....	121
Storing and Recalling Colors .....	122
From Palettes .....	122
From Keypad .....	122
Color Palette Data Window .....	123
<b>Beams</b>	
Overview .....	125
Storing, Modifying, and Recalling Beams .....	126
From Palettes .....	126
From Keypad .....	127
Beam Palette Data Window .....	128
<b>Groups</b>	
Overview .....	130
Storing, Modifying, and Recalling Groups (Basic Operation) .....	130
From Palettes .....	130
From Keypad .....	131
Ordered Groups .....	131
Group Super Palette (Advanced Operation) .....	132
Overview .....	132
Channels Tab .....	134
Arrangement Tab .....	135
Ad-Hoc Tab .....	136
Ad-Hoc Groups .....	136
<b>Other Palette Types</b>	
Dynamics, Effects, Snapshots, Macros, and Stacks .....	138
Media .....	138

## Chapter 6. Basic Cues

### Creating Cues

What Is a Cue? .....	140
Intensity States .....	140
The Four Intensity States .....	140
Setting Intensity States .....	141
Fader Levels .....	141
Storing Cues .....	141
Labeling Cues .....	142
Soft Keyboard Copy/Paste .....	142
Label Shortcuts .....	143
Modifying Cues .....	144
Deleting Cues .....	144
Undo .....	144
Selected Cue Info Display .....	145

### Playing Back Cues

Basic Playback .....	146
Playback Using the Grab Feature .....	147



## Chapter 7. Dynamics

### Dynamics Overview

What is a Dynamic? .....	150
Dynamics Super Palette .....	151
Basic Guidelines .....	152
Methods For Storing Dynamics .....	152

### Dynamics Operation

Canned Dynamics .....	153
Playing Back a Canned Dynamic .....	155
Using the Encoders with Dynamics .....	157
Warning Messages .....	158
Fanning Dynamic Offset .....	159
Storing Dynamics in Cues/Presets .....	160
Storing Dynamics in Macros .....	160
Palette Store Dynamic Only .....	161
Gravity (Roller Coaster Effect) .....	162
Point-To-Point Dynamics .....	163
Storing Dynamics in the Dynamics Palette .....	165
Playing Back a Custom Dynamic .....	166
Dynamics with Keypad .....	167
Dynamics Palette Data Window .....	167

## Chapter 8. Effects

### Effects Overview

What is an Effect? .....	170
Effects Super Palette .....	171
What is a Set? .....	172
What is a Sequence? .....	173

### Creating Effects

Creating a Basic Effect .....	174
Set: Interlaced vs. Sequential .....	176
Sequence: Background State .....	177
Editing Effects .....	178

### Effect Attributes

Overview .....	179
Direction .....	179
Mode .....	180
Start .....	181
Action .....	181
Duration .....	182
Changing Effect Attributes .....	182

### Effect Timing

Overview .....	183
Effect-Level Timing .....	183
Step-Level Timing .....	185
Assigning Timing Values .....	186

### Playing Back Effects

Basic Playback .....	189
Autoload Submaster .....	190
Stop Flags .....	191

### Advanced Operations

Using the Set Edit Screen .....	192
Using the Sequence Edit Screen .....	193
Creating Effects Using Set/Sequence Edit Screens .....	194
Groups as Effect Sets .....	194
Creating Effects From the Command-Line .....	195
Storing Effects as Cues .....	196
Utility Menu .....	196



## Chapter 9. Special Features

### Advanced Control

Manual Timing .....	198
QuickFocus .....	199
Park .....	201
Highlight .....	202

### Data Copy and Move

Copy Channel .....	203
Multi-Channel Copy Channel .....	203
Copy/Move .....	203
Copy Data .....	204
Color/Beam Palette Copy .....	205

### Function Keys

Setting Function Key Option .....	206
Using Function Keys .....	206

### Controlling Media Servers

Overview .....	210
Media Server Setup .....	210
Local Media Folder and File Numbering .....	213
Media Palette .....	213
Server View Lock .....	217
Server Control .....	218
Legacy Media Setup Windows .....	219
CITP: Controller, Interface, Transport, Protocol .....	220

## Chapter 10. Snapshots, Macros, & Board Cues

### Snapshots

Overview .....	228
Storing Snapshots .....	229
Deleting Snapshots .....	231
Recalling Snapshots .....	231
Cue Snapshot Effect Loading .....	232
Snapshot Data Window / Cue Snapshots List .....	232

### Macros

Overview .....	233
Recording Macros .....	233
Using Record Button .....	233
From Keypad .....	234
Macro Recording Prompt .....	235
Macros Data Window .....	236
Recalling Macros .....	238
Canned Macros .....	238

### Board Cues

Overview .....	243
Board Cue Data Display .....	244
Recording Board Cues .....	245
Using Record Button .....	245
From Keypad .....	245
Deleting Board Cues .....	246
Recalling Board Cues .....	246
Board Cue Go/Back as Submaster 1 Go/Back .....	247
Board Cues Window .....	247

## Chapter 11. Advanced Cue Features

### Special Cue Attributes

Cue Attributes Overview .....	250
Link .....	250

Loop .....	251
Wait/Trail Time .....	251
Global Cue Time .....	252
Out Time .....	253
<b>Advanced Cue Storing and Modifying</b>	
How Faders Affect Intensity .....	254
Grand Master/Black Out .....	254
Submaster Faders .....	254
Command-Line Shortcuts .....	255
Using [+] with [Store] .....	255
[Store] [Store] .....	255
Submaster Load .....	255
Cue Store Target .....	256
Cue Attribute Target .....	256
Miscellaneous Shortcuts .....	256
Creating Cue Numbers without Storing Data .....	256
Locating Stored Cues .....	257
Freeze State Cues .....	257
Update .....	258
Track and Fill .....	259
Selective Store .....	260
Selective Recall .....	261
Undo a Delete Command .....	261
Manual Undo To Recorded State .....	262
Modifying Cues in a Submaster .....	262
Store, Update, and Selective Store with Submasters .....	262
Submaster Direct Mode .....	263
<b>Cue Windows</b>	
Cue Sheet .....	265
Forward/Backward Buttons .....	265
Separators .....	266
Renumbering Cues .....	266
Submasters Track Mode .....	266
Submasters Autoload .....	267
Submaster Stop/Step .....	267
Snapshot Indicator .....	267
Cue Data .....	268
Customizing Cue Data Window .....	269
Customizing Cue Data Toolbar .....	270
Cue Editing .....	270
Cue Data Find/Replace .....	271
<b>Cue Stacks</b>	
Overview .....	273
Stacks in the Command Line .....	273
Stacks Palette .....	274
Stacks in the Cue Sheet Window .....	275
Using Stacks with Submasters .....	276
<b>Chapter 12. Submasters</b>	
<b>Submaster Overview</b>	
Submaster Controls .....	278
<b>Submaster Modes</b>	
Overview .....	280
Submaster Modes .....	280
Submaster Choose .....	280
Control and Setup Screens .....	281
Clear .....	282
Priority .....	283
Bump Modes .....	284

Intensity Mode .....	284
Add/Solo Mode .....	285
Go Fader Mode .....	285
IFCB Faders .....	286
Rate .....	287
Timing Disable .....	289
Board Control Disable .....	290
Dynamic Disable .....	291
Freeze .....	292
Inhibitive .....	293
Independent .....	294
Manual Assign .....	295
Intensity Level with Manual Assign .....	296
Channel Filter .....	297
Function Filter (Submaster) .....	298
<b>Playback Intensity Level</b>	
How Playback Intensity is Determined .....	299
Example Intensity Scenarios .....	300
Intensity Transitions .....	301
HTP (Highest Takes Precedence) .....	301
<b>Playback</b>	
Advanced Playback of Cues .....	302
Controlling Linked Playback .....	303
Fade Times for Marked/Zero/Out Cues .....	303
Direct Mode .....	303
Copy/Move Submaster .....	303
Mapping Board Cue Go/Back To Submaster 1 .....	303
External Fader Control via Art-Net Input .....	304

## Chapter 13. System Setups

### Settings

Settings Window .....	306
General Tab .....	306
Actions Tab .....	306
Storing Tab .....	307
DMX In Tab .....	307
MIDI Tab .....	308
Highlight Tab .....	309
Default Explanations .....	310
Emergency Action .....	310
Startup Action .....	310
Date/Time Stamp .....	310
Units .....	310
Palette Store Options .....	310
Use of Filters with Color Store .....	310
Buttons/Keys .....	310
Timecode Autoswitch .....	310

### Display Filters

Loading Filters .....	311
Automatic Display Filtering .....	312

### Multi-Console Features

Setting Up Backup (Secondary) Consoles .....	313
Primary and Secondary Setups .....	313
Online Backup .....	313
Power Up .....	313
Configuring Multiple Consoles .....	314
Channel Partition .....	315

<b>Off-Line Programming</b>	
Performing Off-Line Programming .....	316
<b>Software Updates</b>	
Updating System Devices .....	317

## Chapter 14. 3D Graphic Display

<b>3D Features</b>	
Overview .....	320
Defining a New Venue .....	320
Importing a Venue .....	321
3D Layer Control .....	322
Match 3D .....	322
<b>3D Display Window</b>	
X, Y, Z Locations .....	323
3D Orientation .....	324
Using 3D Graphic Window .....	325
Overview .....	325
Tools .....	326
Modes .....	326
Quick Keys .....	326
3D Graphic Settings .....	327
X/Y Control .....	328
<b>Live/Preview Mode</b>	
Overview .....	329
Using Preview Mode .....	329

## Chapter 15. Show Maintenance

<b>Show File and Data Management</b>	
About Show Files .....	332
Working with Show Files .....	332
Utilities Screen .....	332
Import Show Data .....	334
Save a Copy .....	338
Show File Manager Window .....	338
USITT ASCII Show File Import .....	339
Exporting Patch .....	340
Importing Patch .....	340
Console Log .....	341
Printing .....	342
<b>Updating Profiles</b>	
Overview .....	344
Importing Profiles .....	345
Updating Profiles .....	346
Deleting Profiles .....	347
<b>On-Line Diagnostics</b>	
DMX512 Channel Tests .....	348
Dimmer Check Commands .....	349
Clear Status Errors .....	349

## Chapter 16. Control by External Devices

<b>Concepts</b>	
About MIDI/SMPTE .....	352
Input Options .....	352
MIDI In/Thru/Out .....	352
SMPTE Input .....	352
Switch Closure Trigger Input .....	353



<b>MIDI Notes</b>	
Note Mapping .....	354
<b>MIDI/SMPTE Timecode</b>	
Overview .....	355
Synchronizing Protocol .....	355
Recording .....	356
Timecode Scripts Window .....	356
<b>MIDI Show Control</b>	
Overview .....	359
Variables .....	360
Commands .....	360
Defined [Go] Actions.....	361
MIDI Show Control Output .....	362

## Chapter 17. Off-Line Mode (Visionary)

<b>Visionary Operation</b>	
Overview .....	364
Main Window .....	364
Heads Up Display (HUD) .....	365
Command HUD Operation .....	366
Encoders HUD Operation .....	367
Submasters HUD Operation.....	368
V276 Display .....	369

## Appendix A. Reference

<b>Front Panel and Keyboard Shortcuts</b>	
Front Panel: Submaster Keypad Combinations .....	372
Front Panel: Palette Keypad Combinations.....	373
Mac Keyboard Shortcuts.....	374
<b>Pre-Programmed "Canned" Features</b>	
Canned Dynamics .....	375
Canned Macros .....	376
<b>Glossary</b>	
Glossary of Terms .....	381

## Appendix B. Index

Index .....	392
-------------	-----



# INTRODUCTION

---

## About This Manual

This manual provides operating instructions for the Vx76 software application. These instructions apply to Vx76 software version 3.6.

Familiarizing yourself with this information will help you get the most out of your lighting system.



---

---

**WARNING:** It is important to read ALL accompanying safety and installation instructions to avoid damage to the product and potential injury to yourself or others.

---

---

## Products Covered

Vx76 software is used with the following PRG consoles:

- + V676R Control Console
- + V676® Control Console
- + V476® Control Console
- + V276 On Mac

In some cases the console front panel configurations are different, however, this will be noted in the operating instructions as necessary.

## Additional Documentation

For more information, refer to the following PRG manuals:

- + V676R Control Console Installation & Operation Manual (02.9814.0002)
- + V676® Control Console Installation & Operation Manual (02.9824.0002)
- + V476® Control Console Installation & Operation Manual (02.9813.0002)
- + V276 On Mac Installation & Operation Manual (02.9818.0002)
- + PRG Lighting Systems Networking Guide (02.3004.1000.0)
- + PRG Node Plus User Manual (02.9801.0301)
- + PRG Super Node™ User Manual (02.9821.0001)

For more information regarding DMX512 systems, refer to the DMX512/1990 & AMX 192 Standards publication available from United States Institute for Theatre Technology, Inc. (USITT).

USITT  
6443 Ridings Road  
Syracuse, NY 13206-1111 USA  
1-800-93USITT  
[www.usitt.org](http://www.usitt.org)



For more information regarding Art-Net protocol, refer to the specification for Art-Net II Ethernet Communication Standard available from Artistic Licence Ltd.

Artistic Licence (UK) Ltd (Registered Office)  
24 Forward Drive, Christchurch Avenue,  
Harrow, Middlesex, HA3 8NT, United Kingdom  
+44 (0)20 88 63 45 15 (phone)  
+44 (0)20 84 26 05 51 (fax)  
[www.artisticlicence.com](http://www.artisticlicence.com)

## **Training Videos**

Console Training Videos are available on the PRG website. For a list of videos, refer to the following webpage:

<http://www.prg.com/console-training-videos/>

## **Customer Service**

For technical assistance, contact the PRG International Service Center or contact your nearest PRG office. Contact information for all PRG office locations can be found on our website at: [www.prg.com](http://www.prg.com)

### **PRG Dallas (International Service)**

8617 Ambassador Row, Suite 120  
Dallas, Texas 75247 USA  
Phone: 214.630.1963  
Fax: 214.630.5867  
Service Fax: 214.638.2125  
Service Email: [orders@prg.com](mailto:orders@prg.com)

For additional resources and documentation, please visit our website at: [www.prg.com](http://www.prg.com)

## Obtaining Additional DMX Profiles































































DMX fixtures are controlled by the console using a *profile*. The profile includes the number of DMX channels required to operate the fixture and parameter mapping for console control. A wide range of profiles are included with the console software; however, in the event you require additional profiles please send an email to [profiles@prg.com](mailto:profiles@prg.com). Please be prepared to provide the necessary information to generate the profile as required. (Profiles are covered in "Updating Profiles" on page 344.)

## Text Conventions and Icons

The following button styles are used throughout this manual:

[Button]	Front panel "hard" button. <i>Example:</i> Press [Cue] [1] [Enter] to recall Cue 1.
<Button>	Optional desk button press. <i>Example:</i> Press [Store] <Cue> [n] [Enter].
[Button 1 ] / [Button 2]	Front Panel button combination sequence. Press and hold Button 1 while pressing Button 2.
[Button/Button]	Front Panel button double-click.
⟨Button⟩	Touchscreen "soft" button. <i>Example:</i> Press ⟨Plan View⟩ to open plan view.
<b>Button</b>	Software menu or window dialog button. <i>Example:</i> Click <b>OK</b> . <i>Example:</i> At <b>Operation</b> menu, select <b>Luminaire Status</b> .
ENTER	Mac keyboard key. <i>Example:</i> Hold down ALT on the Mac keyboard.

Note these equivalent buttons on the Mac keyboard and front panel command-line keypad:

<b>Mac Keys</b> WIN =  ALT =  SHIFT = 												
												
												
												
												



**Notes**



**1.**

# GENERAL OPERATION

This chapter provides guidelines for general operation, setting console preferences, and opening a show file.

- + GENERAL OPERATION
- + SETTING PREFERENCES
- + SHOW FILES

## GENERAL OPERATION

### About Vx76 Software

The Vx76 software application provides the graphical user interface (GUI) for console operation. The Vx76 software is built on a Mac OS® platform which will be familiar to all windows-based software users.

The Vx76 software provides standard menu-based operations that can be accessed on the external monitor display(s) by using the cursor or by touching the displays themselves (in the case of touch-enabled monitors). The software also provides the interface for the touchscreens available on the front panel (desk). In many cases, operations can be done using either the front panel touchscreens or the menus. This manual covers operations on the front panel touchscreens, however, these operations could also be done using the menu system. In most cases, the touchscreen interface and menu-based windows look the same.

The Vx76 software may be upgraded as new features become available.

### Power Up Console and Launch Vx76 Application

Use the following procedure to power up the console and Mac computer, and to launch the software application.

#### To power up and launch:

- Step 1. At rear of console, set breaker switch to ON position.
- Step 2. *V676 console only.* At Mac computer, press power button. Wait for computer to boot up and front panel to initialize.
- Step 3. At Mac desktop, double-click Vx76 icon to launch application. A new show file (or last open show file) will automatically load and Task Progress window will show progress of data downloads.



### Restart Front Panel (V476/V676 Only)

When the console's blue power-down button is pressed, a shutdown dialog will be displayed on the central touchscreen. The dialog contains two options: 'Shutdown Front Panel', which independently powers down the front panel, and 'Shutdown All', which powers down the front panel and the computer.

#### To restart front panel:

- Step 1. At front of console, press and hold power-down button.
- Step 2. At touchscreen, press (Shutdown Front Panel). (During a Front Panel Shutdown, the blue power-down button will slowly flash to indicate that it is in sleep mode.)
- Step 3. To restart front panel, press power-down button again.

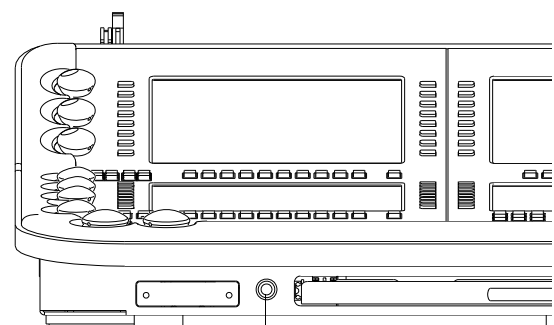

V676 Power-Down Button

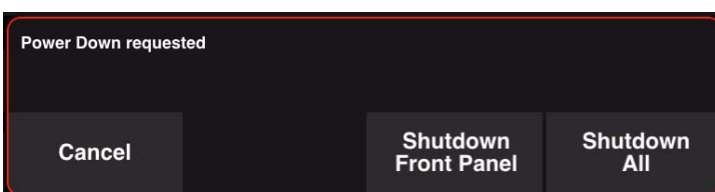

## Restart Vx76 Application

The Vx76 software application can be independently closed and restarted. This is useful for upgrading the software or for restarting the application itself.

### To shutdown and restart Vx76 application:

- Step 1. At Vx76 menu, select **Quit Vx76**. Allow application to completely shut down.
- Step 2. At Mac desktop, double-click Vx76 icon to relaunch application. A new show file (or last open show file) will automatically load and Task Progress window will show progress of data downloads.

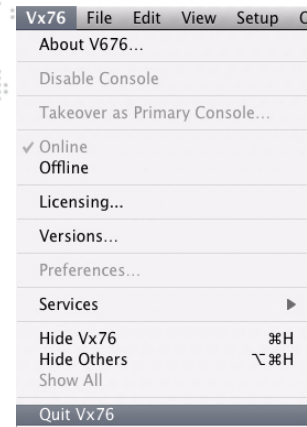
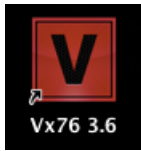

## Power Down Console (V476/V676 Only)

When the console's blue power-down button is pressed, a shutdown dialog will be displayed on the central touchscreen. The dialog contains two options: 'Shutdown Front Panel', which independently powers down the front panel and 'Shutdown All', which powers down the front panel and the computer.

### To power down console:

- Step 1. At front of console, press and hold power-down button.
- Step 2. At touchscreen, press <Shutdown All>. Allow front panel and computer to completely shut down.
- Step 3. At rear of console, set breaker switch to OFF position.

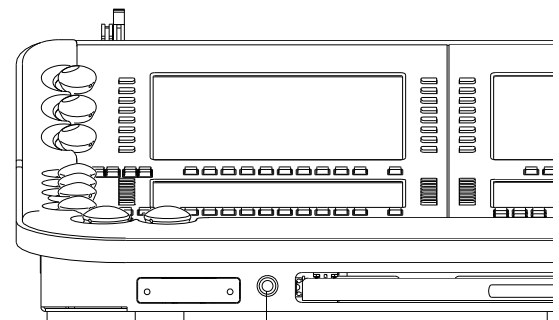

V676 Power-Down Button

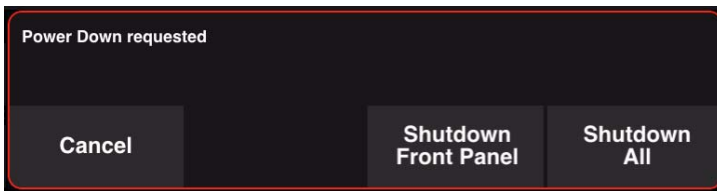

## Power Down Console (V276 On Mac Only)

### To power down console:

- + At rear of console, set breaker switch to OFF position.

## Window Operation

The Vx76 application functions like any standard windows-based computer software. A menu bar provides access to system windows and controls.

### Working with the Windows:

The Window menu offers several functions that assist with locating and sizing windows:

- + **Minimize** will minimize the current top window.
- + **Zoom** will enlarge the current top window.
- + **Bring All to Front** will bring the Vx76 windows to the top of the Finder.
- + **Clear Window States** will close and clear all Vx76 windows.
- + A list of currently open windows will appear at the bottom of the Window menu. A dot will indicate the current top active window (such as Cue Data in the example to the right). Select the name of any visible window to bring it to the front.

### Entering/Editing Window Data:

The computer keyboard can be used to type in alpha-numeric entries or select cells and fields in the windows.

- + Pressing ENTER closes the entry field.
- + Pressing ENTER automatically selects the next cell down in the column for editing.
- + Pressing SHIFT + ENTER automatically selects the next cell up in the column for editing.
- + Pressing TAB selects the next cell or field in a row.
- + Pressing SHIFT + TAB selects the previous cell or field in a row.
- + Use ARROW buttons to move cursor through fields.

The trackpad can be used to manipulate the cursor for field/cell editing, clicking radio buttons, accessing pop-up menus, moving windows, or closing windows.

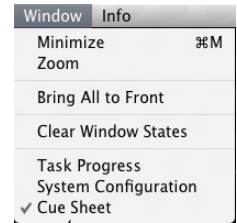
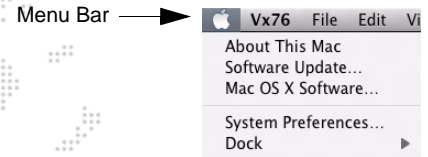

List of currently open windows

### Sample Window

Use cursor to interface with the windows

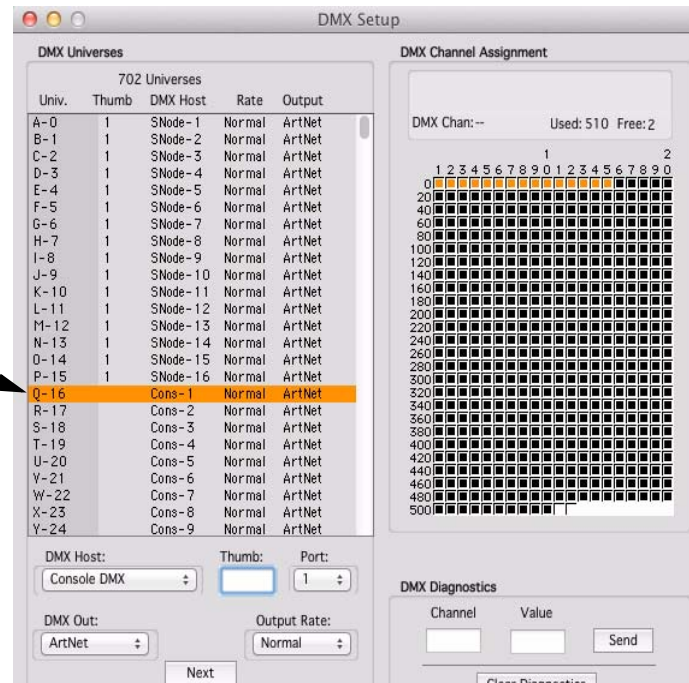



## Restoring Vx76 Application:

The Mac desktop dock will contain an icon for the Vx76 application once the software is running. To restore Vx76 as the top application, select its icon from the dock.



## Status Indicator Bar

The status bar, located at the bottom of the external monitor display, provides information about current console status and operations.

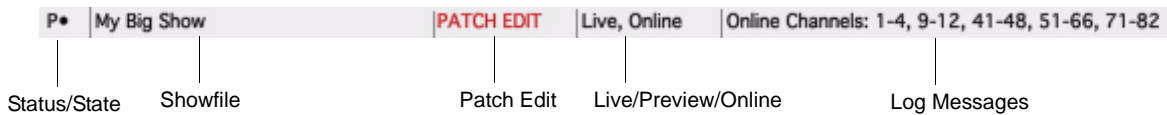

### Status/State

Indicates the console state or status in relationship to communication between the CPU and Console Interface Card (CIC). The following indications may be displayed:

- + **P** - Primary: The console is up and running in the Primary state.
- + **PP** - Primary Prep: The console is opening a show file.
- + **PL** - Primary Load: The console is loading data from the show file.
- + **PS** - Primary Select: The console is waiting on a user selection.
- + **U** - Unknown: The console is in an unknown state.
- + **\*\*** - Error: The console is in an error state due to an internal communication problem.
- + **NL** - Net Listen: The console is looking for other active consoles on the network.
- + **S** - Secondary: The console is up and running in the Secondary state.
- + **SP** - Secondary Prep: The console is synchronizing a show file from the primary.
- + **SL** - Secondary Load: The console is loading data from the show file.
- + **WP** - Wait for Primary: The console is waiting for a primary console to be found or selected.

### Showfile

Displays the name of the currently open show file.

### Patch Edit Enabled/Disabled

"Patch Edit" is displayed when patch is enabled.

The box is blank when patch editing is disabled.

## Live/Preview/Off-Line Mode

Indicates whether the console is in the Live, Preview or Off-Line mode.

- + **Live Mode** - used for live editing. While in Live mode, any manual control actions or event recalls (cues, effects, dynamic states, etc.) will be executed, in real time, on stage. (Refer to "Live/Preview Mode" on page 329.)
- + **Preview Mode** - used for preview editing. While in Preview mode, any manual control actions are stored to the appropriate luminaires, but are not executed on stage. (Refer to "Live/Preview Mode" on page 329.)
- + **Off-Line Mode** - allows preprogramming without having to connect to a system. (Refer to "Off-Line Programming" on page 316.)

## Log Messages

Messages highlighted in the Log Message box are the same messages collected in the Console Log. Refer to "Console Log" on page 341.

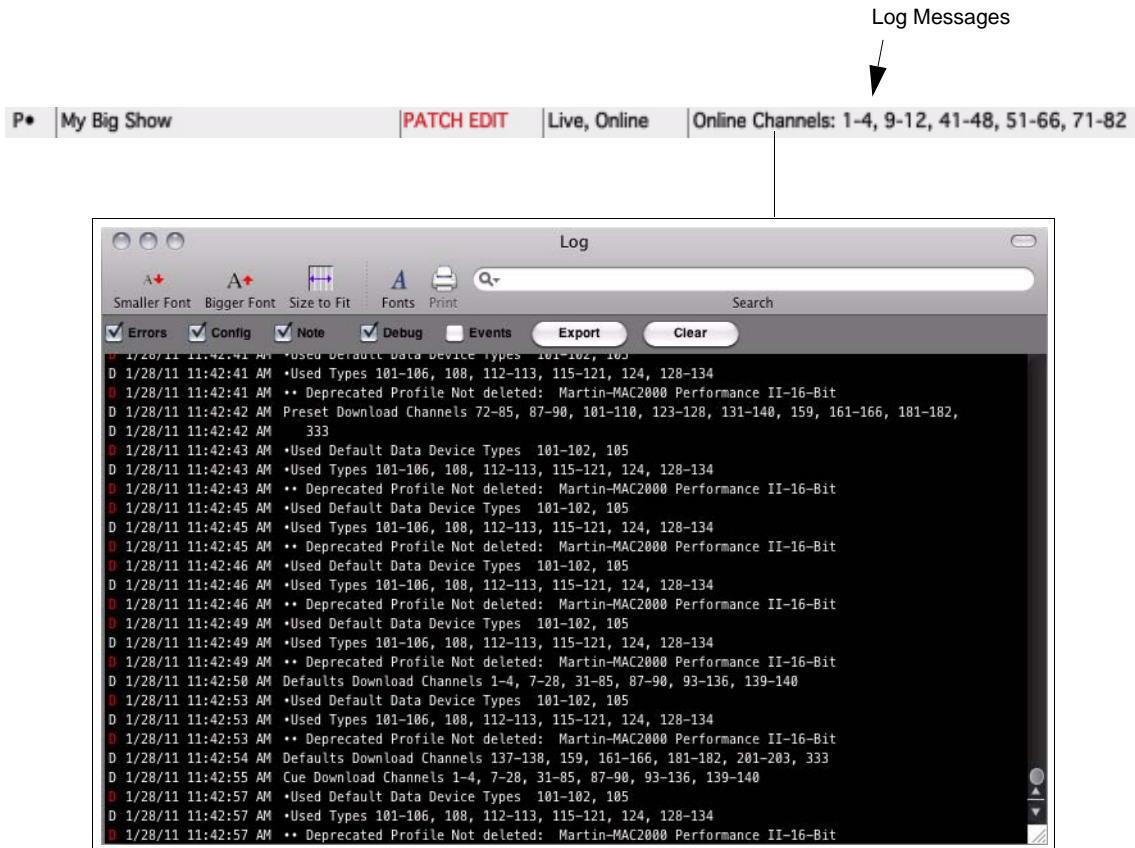

## SETTING PREFERENCES

### Brightness Level (V476/V676 Only)

#### For Front Panel and Monitors

The brightness level can be set for all monitors, desk lamps, faders, and backlit switches. This is done by pressing the appropriate button at the Submaster panel while turning the Rate encoder.

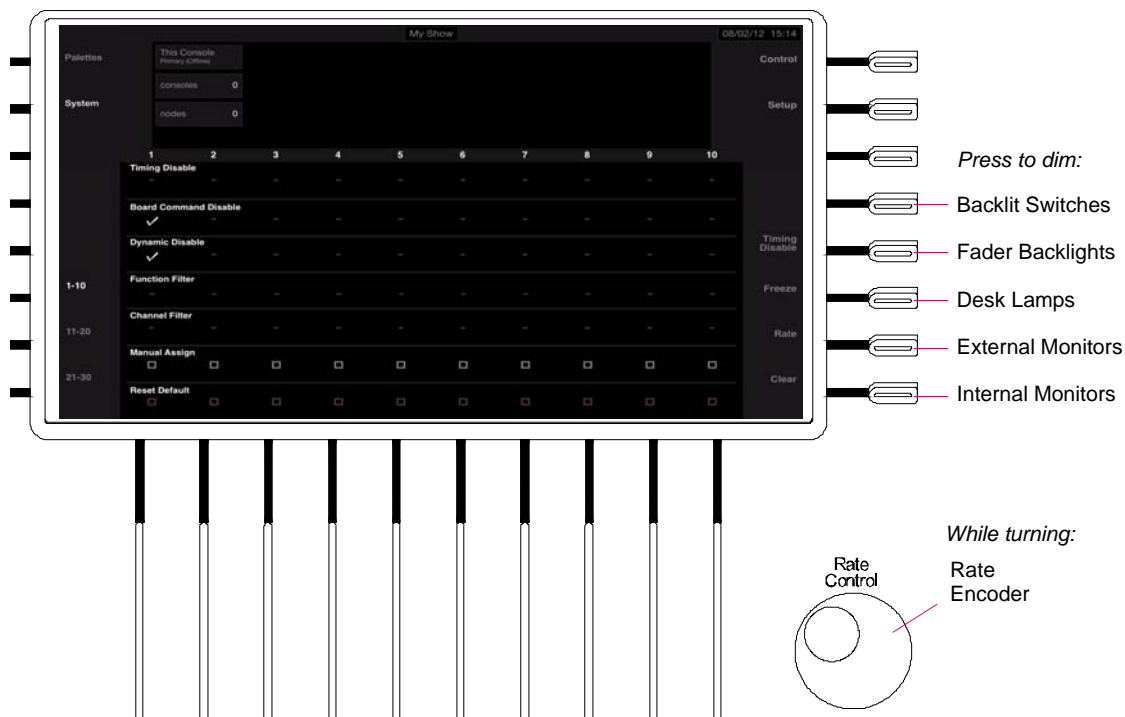

Figure 1-1: V476/V676 Submaster Panel

#### To set a new brightness level:

- Step 1. At Submaster panel, press and hold appropriate hard button to activate dimming. Options are:
  - a. "Blank" button above Timing Disable controls backlit switch dimming level.
  - b. Timing Disable button controls fader backlights.
  - c. Freeze button controls desk lamps.
  - d. Rate button controls external monitors.
  - e. Clear button controls internal monitors (front panel displays).
- Step 2. While holding down button, turn Rate encoder until desired brightness level is reached.
- Step 3. Release button. New brightness level will be set.

#### For Keyboard

The brightness level can be set for the pull-out Mac keyboard.

#### To set a new brightness level for keyboard:

- Step 1. At keyboard, press and hold FN (function) key.
- Step 2. While holding down key, press Up/Down buttons until desired brightness level is reached.
- Step 3. Release key. New brightness level will be set.

# IMPORTANT NOTES REGARDING DIFFERENT TYPES OF VX76 CONSOLES

## Special Features to Accommodate the V476 Front Panel

The V476 console provides the same programming capacities and capabilities as the V676 console, however, the desk is smaller and only one external monitor is provided. Since the same Vx76 software application is used on both consoles, special features were added with Vx76 software version 2.5 to accommodate the differences in hardware.

These special features are as follows:

- + **Sliding Encoder Sidebar** - The sliding Encoder Sidebar is used with the six "soft" encoders available on the V476 desk (**Figure 1-2**). The V676 has a designated area for displaying encoder controls, but since the V476 desk is smaller, these controls are displayed using the sliding sidebar. The sidebar appears in the same space as the central and palette displays when an encoder is turned or an encoder function button is pressed.
- + **Palette Workspace Swapping** - The palette workspace swapping translates the three V676 palette display spaces to the single V476 palette display. (Since the three workspaces correspond to the three V676 palette displays, stored snapshots are interoperable on both consoles.) Refer to **"Workspace Swapping"** on page 13 for more information.
- + **External Display Workspace Swapping** - The external display workspace swapping translates the three V676 external display spaces to the single V476 external display. Refer to **"Workspace Swapping"** on page 13 for more information.

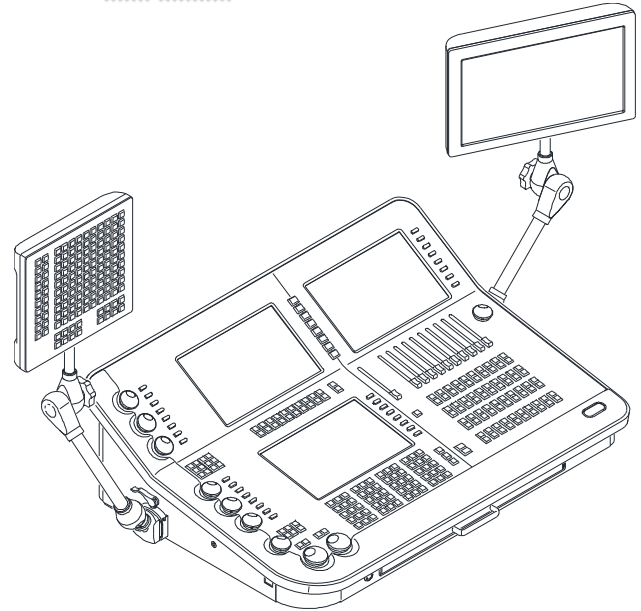

V476 Control Console

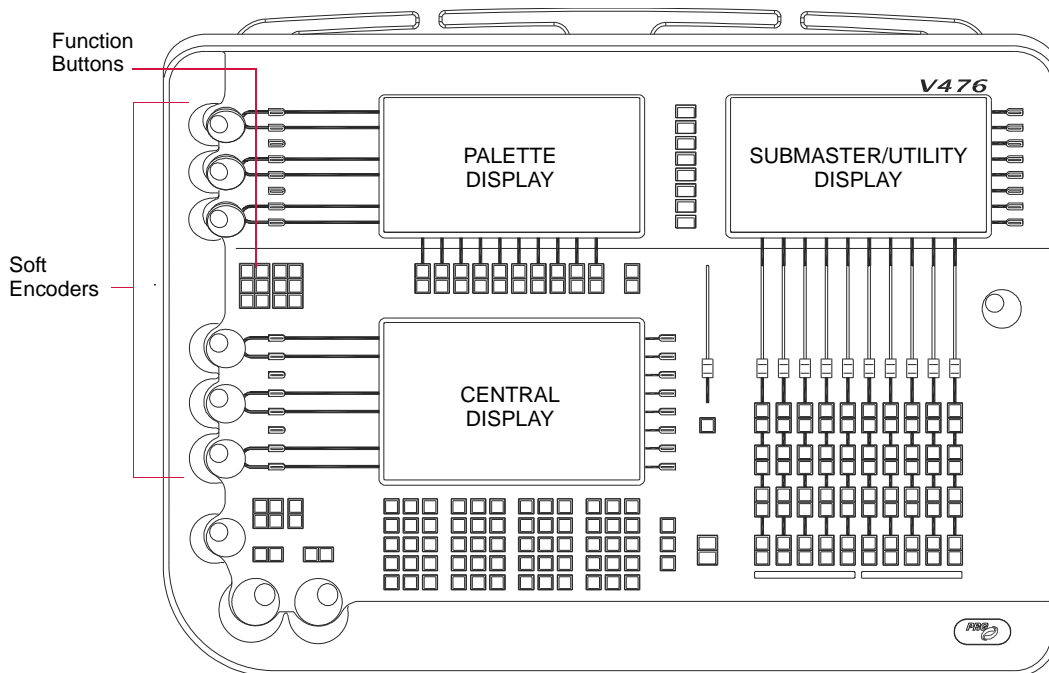

Figure 1-2: V476 Desk Layout

## Workspace Swapping

The V476 palette display space can display one of three different palettes (corresponding to the three palettes available on the V676 desk). To switch between palettes, press the appropriate button on the right side of the palette display.

This feature also works on the external display monitor to match the three external monitors available with the V676 console. To switch between monitor display views, press the appropriate button on the right side of the palette display. (When switching to a different external display view, the windows that are open in that workspace will be displayed.)

The workspace swapping feature makes it possible to utilize the same stored Snapshot configurations on both models of console.

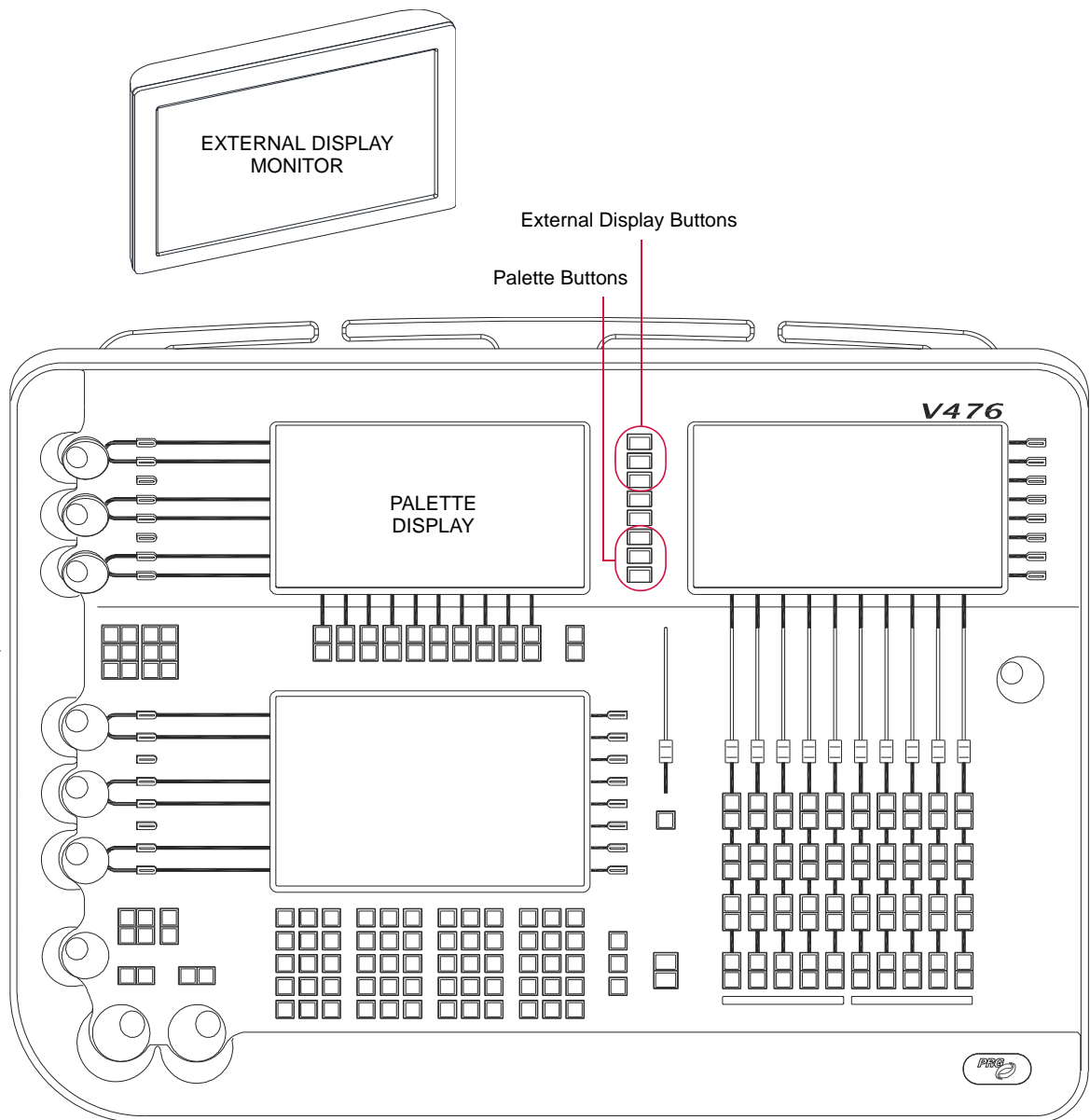

Figure 1-3: V476 Desk and Monitor

## Special Considerations for the V276 On Mac

The V276 On Mac console is considerably different from V476 and V676 consoles in that its front panel does not contain any touchscreen displays or, in some cases, the same hard buttons. This does not affect its capability to perform the same functions as the other Vx76 console types, however, in it may be necessary to use various desktop windows in order to perform the same actions. For example, the V276 front panel does not have a central touchscreen, but the same command-line data can be displayed and controlled using the V276 HUD window. Likewise, the V276 On Mac front panel does not contain submaster Run, Stop, or Step buttons, but these can be controlled using the Submaster HUD window.

In many cases, console operations can be performed at either the front panel using touchscreen displays and hard buttons, or in the corresponding desktop windows, although this manual typically illustrates one or the other for clarity. Since the desktop windows look almost identical to the touchscreen displays, it is easy enough to adapt the instructions to either. In cases where V276 operation is radically different, this will be detailed in the appropriate section of the manual. If the operations are similar, it may be that examples are shown using only one console's particular hardware, however, be aware that the instructions will still apply to your specific console.

The primary areas where the V276 On Mac front panel differs from the other Vx76 consoles are as follows:

- + No front panel touchscreen displays - use equivalent desktop windows such as V276 HUD, Submaster HUD, Palettes, etc. (Refer to "V276 Display" on page 369.)
- + No dedicated submaster rate encoder - use the virtual Rate knob available on the Submaster HUD. (Refer to "Submasters HUD Operation" on page 368.)
- + No front panel [Online] button - select **Online** or **Offline** from the **Vx76** menu or use <Online> button available in the Channel Select window.
- + No front panel [Run], [Stop], or [Step] buttons - perform these actions using the Submaster HUD.
- + No front panel [Blackout] button - bring the Grand Master fader to zero.

The V276 On Mac also offers buttons that are only found on this console's front panel.

- + The first set of buttons are used to open windows on the desktop, such as the Function Filter, Timing Filter, Snap Shots, or Channel Select. For example, pressing the [Chan Select] button will open the Channel Select window:

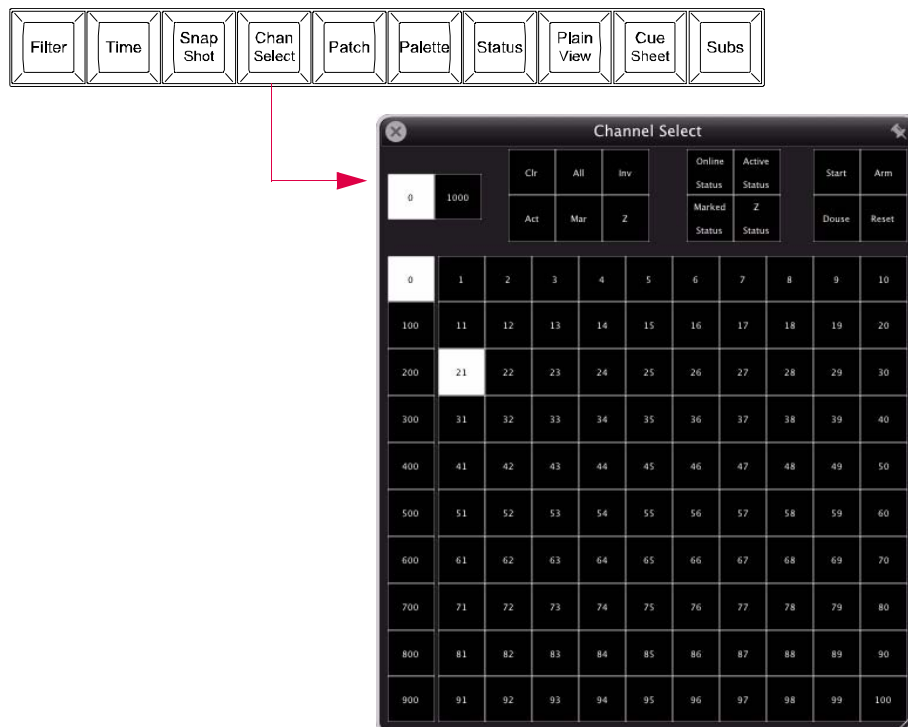

Figure 1-4: V276 Window Buttons

+ The next set of exclusive buttons are used in conjunction with the V276 HUD palette. For example, when the V276 HUD window is open, pressing [1] will select palette entry 1 of the selected page/bank. (Refer to "V276 Display" on page 369.)

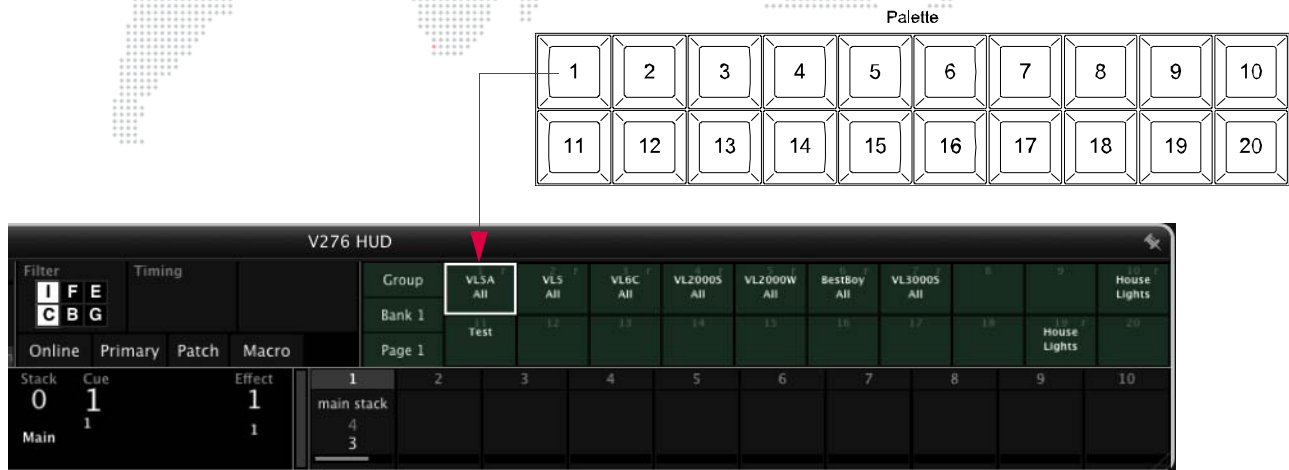

Figure 1-5: V276 Palette Buttons

# SHOW FILES

## About Show Files

All programming information for a production (i.e., a show) is stored in a *show file*. Show files are made up of individual data files nested within a show file folder. When the Vx76 software application is launched, it will automatically open the last show file used on the console, unless one is not available, in which case a new show file is automatically opened.

Show files can be managed by one of two methods: 1) using the Utilities screen available in the console's central touchscreen, or 2) using the Show File Manager window available in the Mac menu bar. These controls allow show files to be opened, duplicated, renamed, deleted, imported, and/or archived to an external storage device.

**Note:** This section provides an introductory overview of show files. For more in-depth instructions, refer to the "[Show File and Data Management](#)" on page 332.

## Utilities Screen

The central touchscreen Utilities screen is used for show file management. (The functions are the same as the Show File Manager Mac window.)

- + Press the (Utilities) button on the touchscreen to open the show file controls.

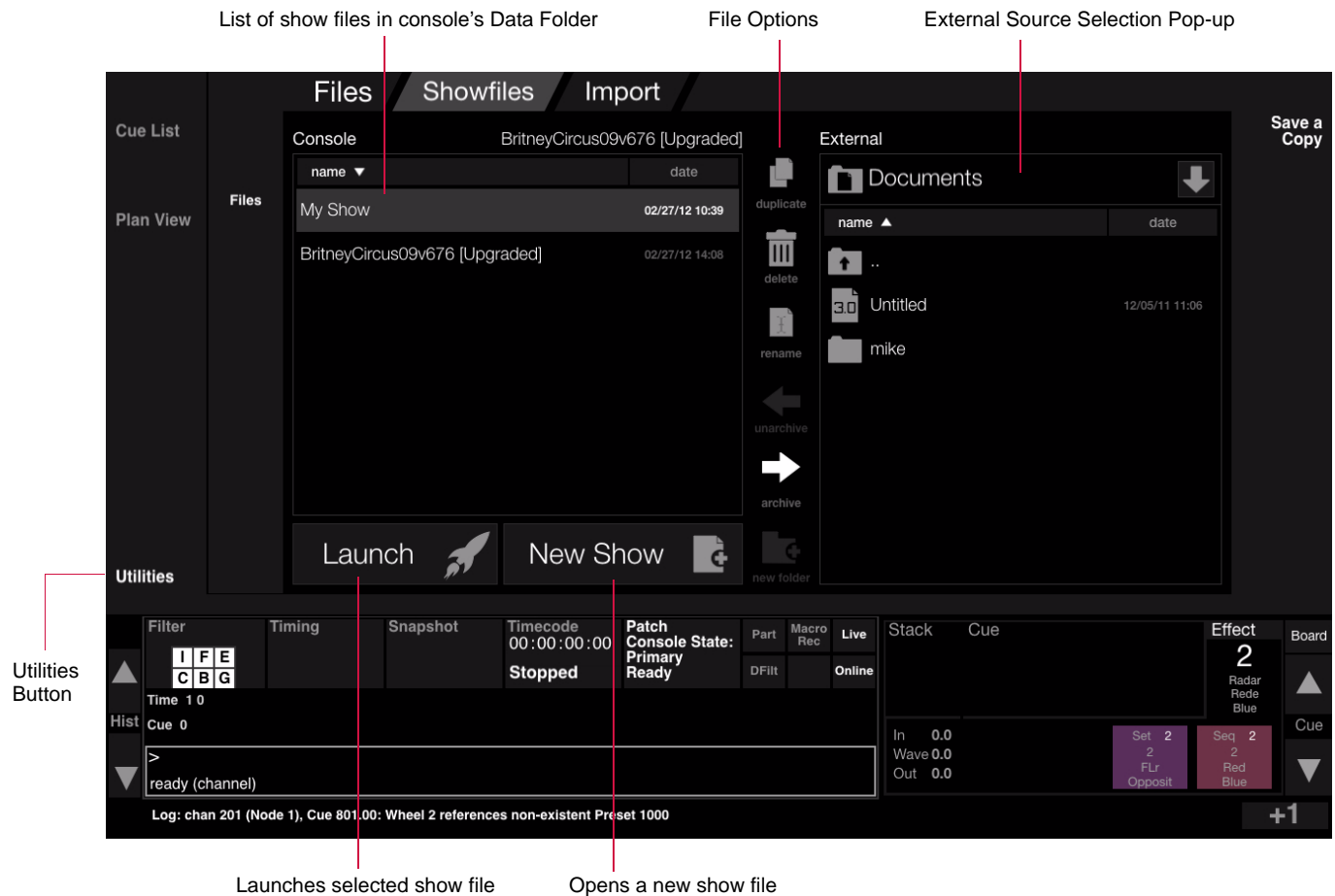



### To open a new show file:

A new show file can be opened at any time.

- + At Utilities screen, press <New Show> button.

### To rename, duplicate, or delete a show file:

Only show files resident on the console's hard drive can be renamed, duplicated, or deleted.

- Step 1. At left "Console" showfile list, select show file.
- Step 2. Press <Delete>, <Rename>, or <Duplicate> button as required. (Delete will require a confirmation.)

## Show File Manager Window

The Show File Manager software window (available at the **File** menu) is also used for show file management. (The functions are the same as the touchscreen Utilities screen.)

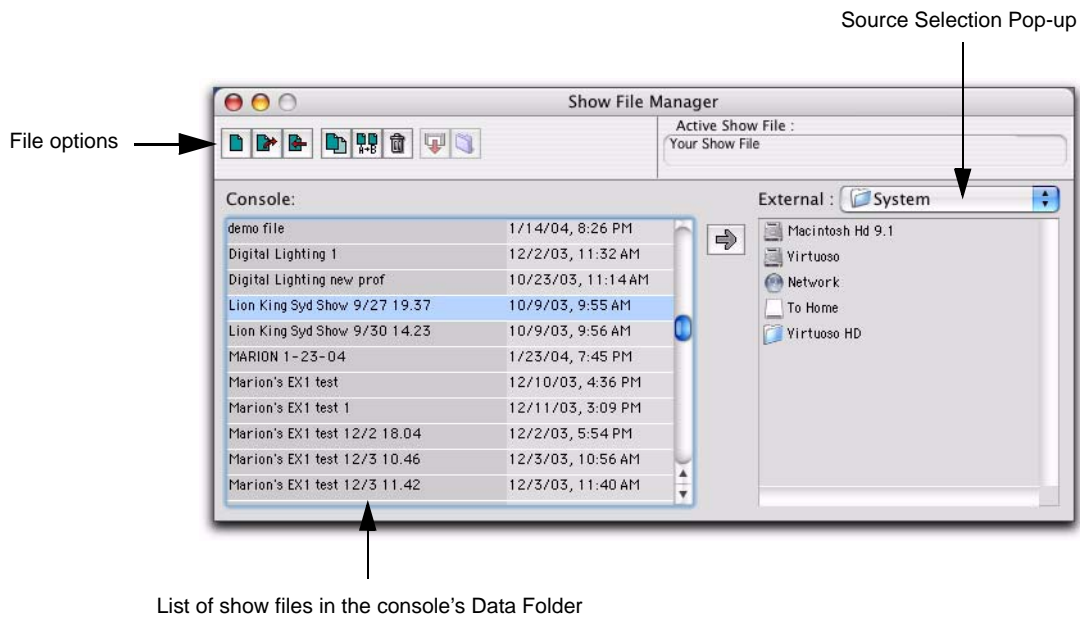



## Notes



## 2.

# CONFIGURATION AND PATCH

This chapter provides instructions for configuring the system and patching fixtures.

- + SYSTEM CONFIGURATION
- + PATCH
- + PLAN VIEW

# SYSTEM CONFIGURATION

## System Configuration Overview

The system configuration tools provide details and configuration options for the console and system devices. The configuration can be stored for future reference using the Store/Clear actions.

Note that the <System> button must be pressed to view the system info. Pressing <Palettes> will display a palette.

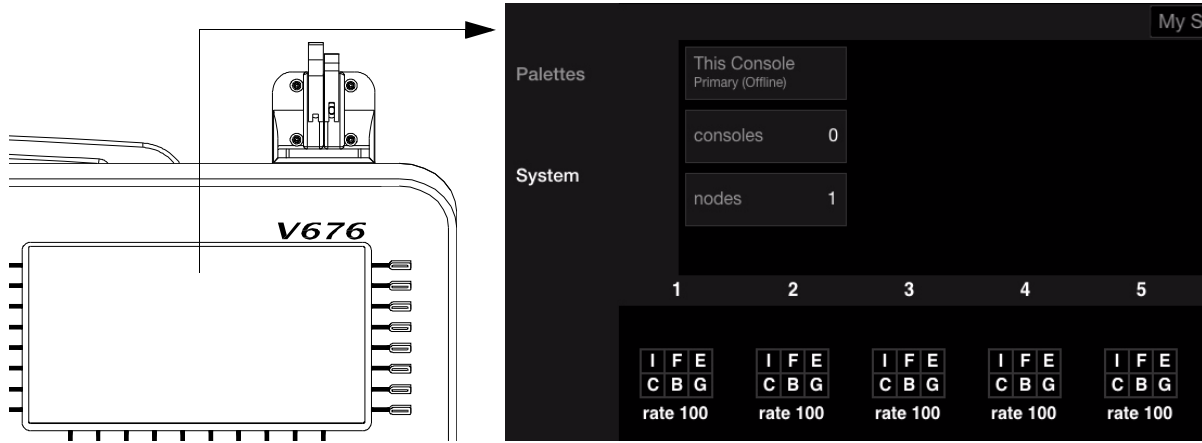

The main configuration screen allows access to the following items:

- + **Console Name and Details** - Pressing <This Console> will display the console's primary/secondary status and online/off-line status.

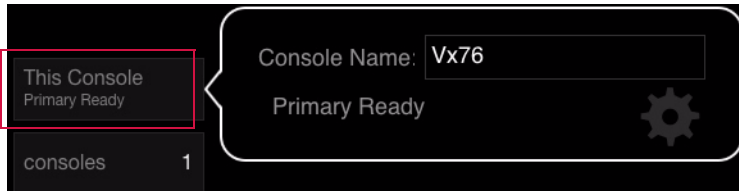

- + **Other Consoles** - Pressing <Other Consoles> will display information about other consoles that may be connected to the system.

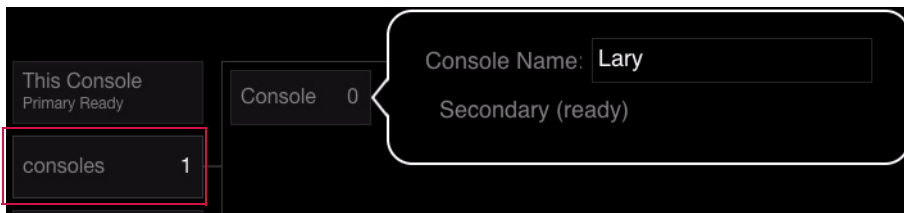

- + **Nodes** - Pressing <Nodes> will display all connected Node devices.

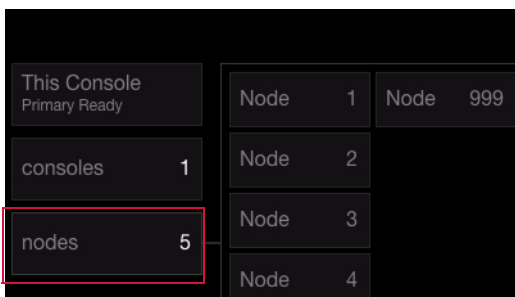

## Using System Configuration

### Naming a Console

The console naming feature is useful to identify each console when two or more consoles are connected to a single system. For example, you could name the consoles "Main" and "Backup." (Also refer to "[Setting Up Backup \(Secondary\) Consoles](#)" on page 313). The console name can be set or changed at any time using the System Configuration screen or Version Info window.

#### To name a console using System Configuration:

- Step 1. Press <This Console>.
- Step 2. Touch Console Name field.
- Step 3. Enter name. For example, "Vx76" as shown below.

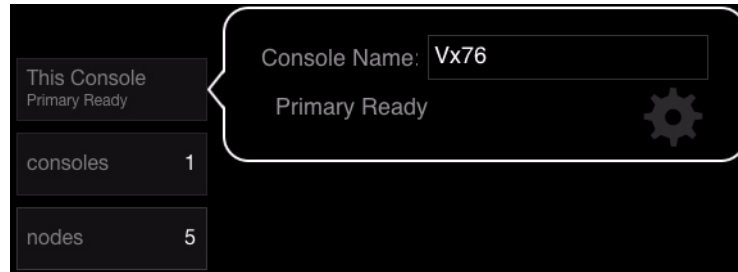

#### To name a console using Version Info window:

- Step 1. At Vx76 menu, select Versions.
- Step 2. At name field, type a console name.
- Step 3. Close window.

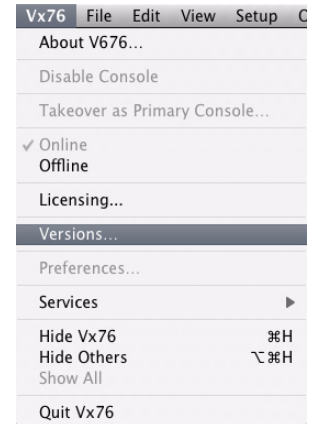
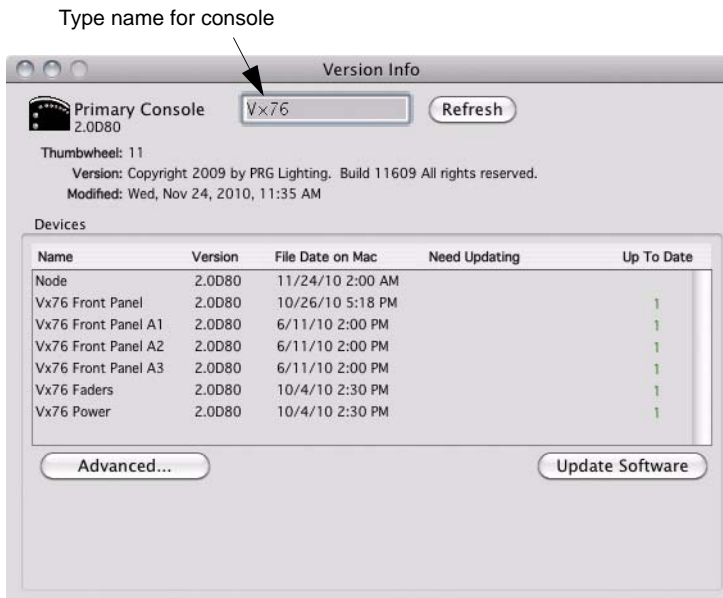

## Store/Clear Configuration

Your system setup can be stored for future reference. After the configuration is stored, if a device is not online when the system is powered up, the missing device will be indicated in a darker gray color.

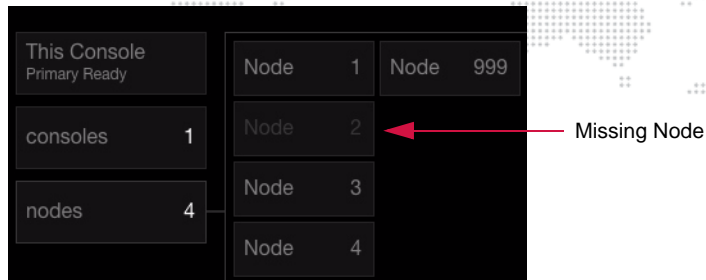

### To store system configuration:

- Step 1. Press <This Console>.
- Step 2. Press gear icon to bring up Store and Clear options.
- Step 3. Press <Store Config>.



### To clear stored configuration:

- Step 1. Press <This Console>.
- Step 2. Press gear icon to bring up Store and Clear options.
- Step 3. Press <Clear Config>.

## Error Messages

If the console detects an error with a connected device, this will be indicated in red.

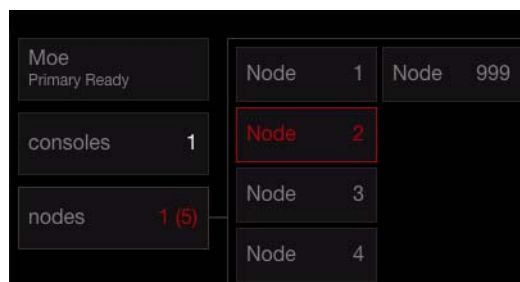

## Clear Errors / Reset Node

Nodes can be reset from the System Configuration screen.

### To clear or reset node:

- Step 1. Press <nodes>.
- Step 2. Press button of required Node.
- Step 3. Press <Clear Errors> and/or <Reset> as required.

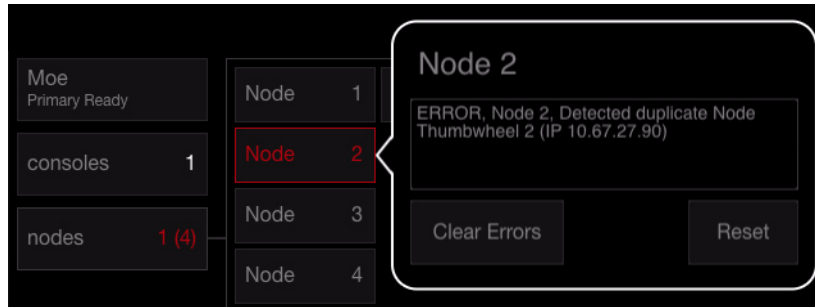

## Update Configuration

In the event a new device(s) is added to your system while the console is powered up, the system can be repolled so that the new device(s) will appear in the System Configuration window.

---

**Note:** This is not related to the Stored Configuration.

---

### To update a configuration:

- + At Special menu, select Update Configuration.

Special	Patch	Window	Info
Task Progress			⌘⌘T
Clear Status Errors			
Enable Remote Focus Control			
Park			
UnPark			
Select Parked			
Encoder Fan			▶
QuickFocus			⌘F
Highlight			
Select			▶
Manual Timing			
Status			▶
Reset ( Recalibrate )...			
Home...			
Erase Luminaire Data...			
Log Network Statistics			
Update Configuration			⌘U
Store Configuration			
Clear Stored Configuration			
Load Partition			
Load Display Filter			⌘D
Auto Display Filter			⇧⌘D
Clear Display Filter			

## Ethernet Configuration

The Ethernet settings for properly prepped consoles should be suitable for operation and will not require any configuration. However, if improper settings are detected, the Ethernet window can be used to resolve errors.

### To view/change settings:

- + At **Setup** menu, select **Ethernet**.

The Ethernet window displays the current status of the Ethernet network, and offers a method for auto-configuration in the event there is a problem.

The Vx76 control network is designed to work on the 10.67.x.x subnet. One of the computer's built-in ports should be configured to an address in this subnet. If the software cannot find an active port set to that subnet, then an error message will be displayed on the front panel, and the Ethernet dialog will be displayed. If the problem is the port configuration, the **Auto-Configure** button will modify the network settings accordingly. If this does not work, check the physical connections to the back of the computer, or replace the Ethernet/USB cable to the front panel.

Setup	Operation	Data
Settings		
Ethernet		
Pairing		
System Config	⌘K	
Calibrate Screen		
Legacy Media Setup		
Media Server Setup		
Log		⌘L
Play View		⌘P

Indicates that the network device configuration is valid.

Indicates that there is an active link on the port.

Indicates whether system traffic has been seen on the port.

Media Server CITP Info

Art-Net Interface Info

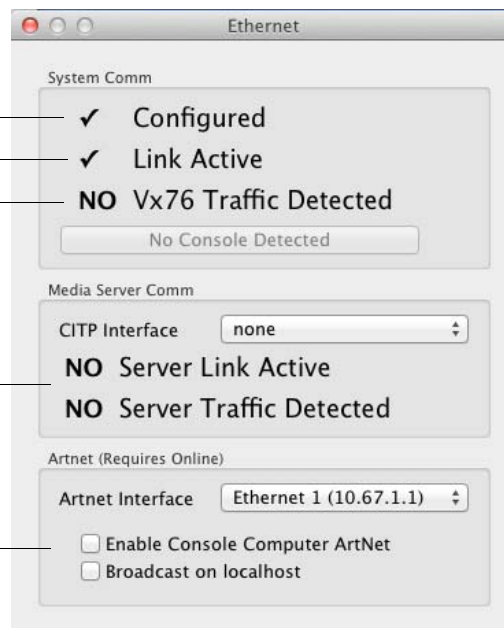



## Device Pairing

For proper operation, the software must pair with different pieces of hardware within the console. This process is completed during the console's installation, but may need to be paired again if internal devices are changed.

Pairing console devices can be accomplished as follows:

- Step 1. At **Setup** menu, select **Pairing**. (Pairing window will open.)
- Step 2. Click **Pair Devices** button.
- Step 3. Disconnect external system networking (Ethernet and/or fiber) from back of console and press **Scan** to continue.
- Step 4. Once all devices have been discovered, click **Pair** to complete the pairing process.

Setup	Operation	Data
Settings		
Ethernet		
Pairing		
System Config	⌘K	
Calibrate Screen		
Legacy Media Setup		
Media Server Setup		
Log		⌘L

---

**Note:** Some devices, such as the Vx76 DMX Interface, are optional, and may not be installed on the console.

---

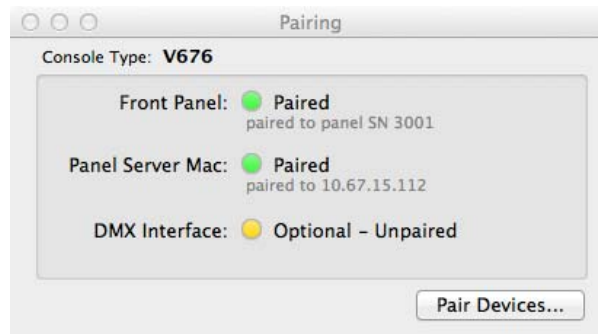

# PATCH

## Patch Overview

Patching is the simplest way to manage the fixtures connected to the console. Patch associates a single control channel with a single fixture so that you can select one channel at the console and have control of all the fixture's parameters (intensity, color, beam, etc.). The patch operates by creating a look-up table that the console uses to translate a fixture's associated DMX address(es) into a single control channel.

Patching can be done via the command line or Plan View.

## Profiles

DMX fixtures must be patched to the console using a *profile* in order to be controlled. The profile includes the number of DMX512 channels required to operate the fixture and all parameter mapping necessary for control by the console.

Profiles are stored in a Vx76 system folder which is accessed each time a new show file is opened.

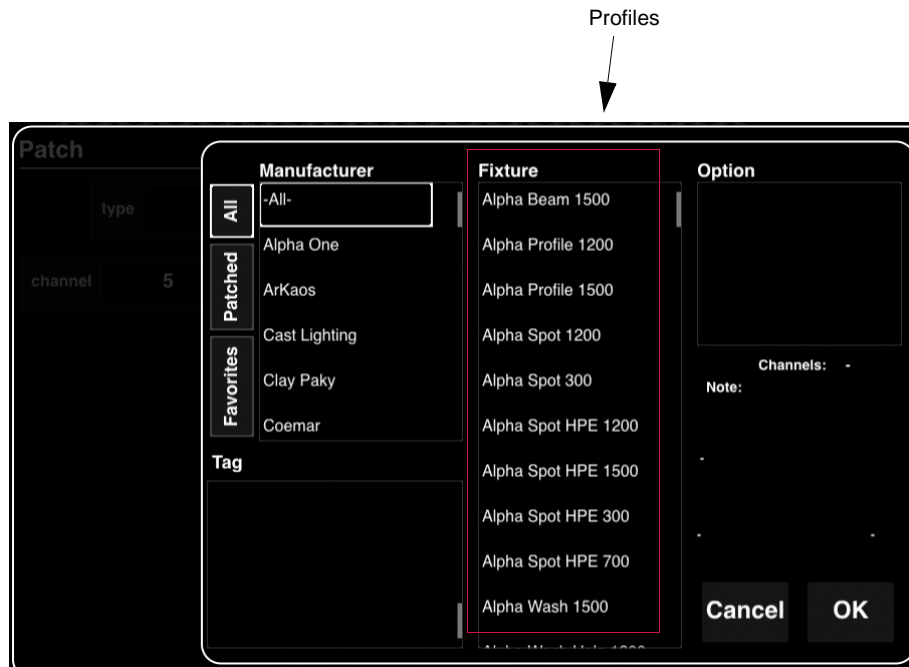

**Note:** Also refer to "Updating Profiles" on page 344.

## DMX Universes

The console provides for a maximum of 702 universes (labeled A thru ZZ), which are assigned to DMX buses or "hosts" (hardware outputs within the system). This means that the actual amount of buses available will depend on your system setup.

### To define DMX512 universes:

- Step 1. At **Setup** menu, select **DMX Setup**. (DMX Setup window will open.)
- Step 2. Select desired DMX Universe.
- Step 3. Enable Patch Edit by pressing **Patch Edit** button at bottom of window.
- Step 4. Select "Super Node" from DMX Host menu.
- Step 5. Enter Node thumbwheel address in "Thumb" field.
- Step 6. Choose "Port" output.
- Step 7. If assigning multiple universes, click **Next** or press [Enter] to edit the next universe. Otherwise, select **Disable Edit** to disable patch edit and save changes.

Setup	Operation	Data
Settings		
Ethernet		
Pairing		
System Config		⌘K
Calibrate Screen		
Legacy Media Setup		
Media Server Setup		
Log		⌘L
Plan View		⌘B
Patch		⌘T
3D Location		
<b>DMX Setup</b>		

**Note:** If patching sequential Nodes and outputs, pressing the [Return] button on the keyboard will auto increment the patch. If not sequential, repeat Steps 4 through 6.

DMX Universe (A-ZZ)  
Must be assigned to a  
DMX Host (Node, etc.)

Host Device

Node Address

DMX Output of Node

Advance Button -  
Press to enter current settings  
and advance to the next line

Enable/Disable  
Patch Editing

DMX  
Output Rate

Port #

For use with DMX Diagnostics feature \*

Orange highlights  
show DMX channel  
range for selected  
fixtures

DMX512 channel  
assignments for  
selected universe

\* For instructions on using DMX diagnostics, refer to "DMX512 Channel Tests" on page 348.

## Streaming ACN

Each PRG Node Plus output port can be configured to send ANSI E1.31 Streaming ACN (sACN) format packets over the Ethernet port instead of Art-Net packets. This selection is made by setting the **DMX Out** option to "sACN" and clicking the **Set** button. (The default output type is Art-Net.)

**Note:** E1.31 does not allow universe 0, so that universe cannot be used with sACN.

## Patch Procedures

Luminaire patching can be done using the command-line keypad and central touchscreen. (It can also be done using the Plan View, however, this is covered in "Plan View Layouts" on page 41.)

### Enabling/Disabling Patch Editing

To enable patch editing:

- + Press the <Patch> button on the touchscreen. (It will be highlighted in yellow and display "Patch Editing" when the editing mode is active.)

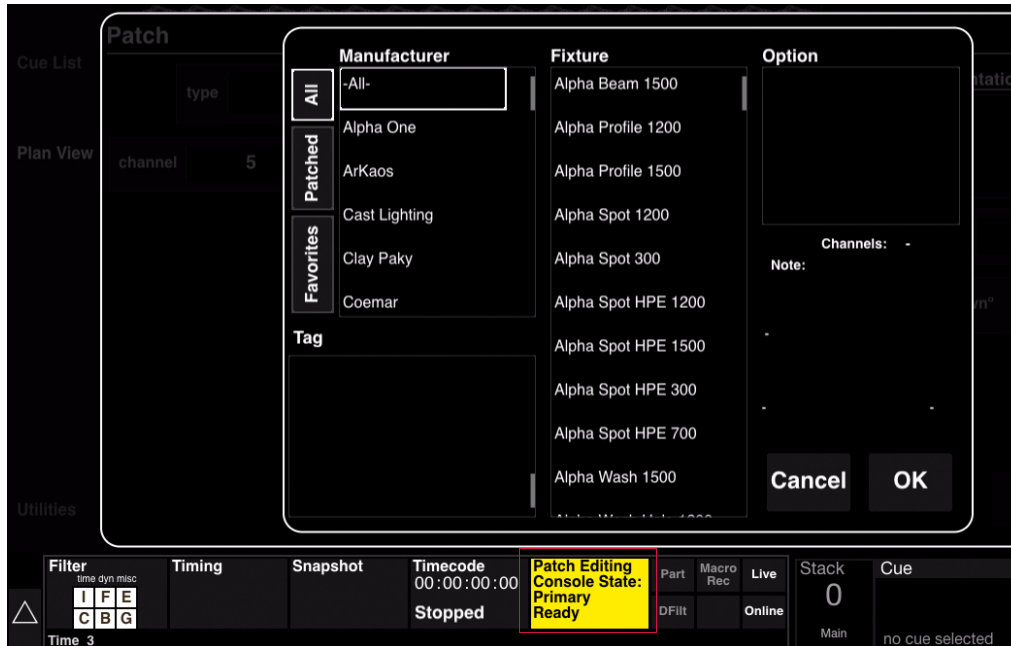

To exit patch editing (disable):

- + To exit patch editing, press the <Patch Editing> button. A confirmation dialog will allow you to save or discard changes, or return to editing (cancel).

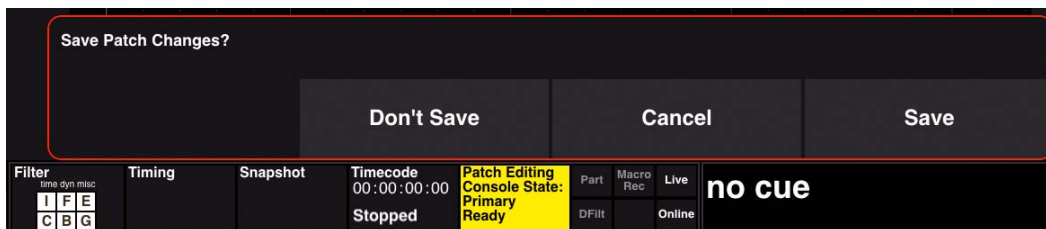

## Patching DMX Fixtures

The patch setup screens will be slightly different depending on whether a DMX fixture or conventional fixture is being patched.

### To patch a DMX fixture:

- Step 1. At command-line keypad, press [Patch] button. Patch dialog will open in central touchscreen and Patch Editing mode will be enabled.
- Step 2. First select a Manufacturer, then the Fixture type, then an Option (if applicable - not all fixtures will have options).
- Step 3. Press <OK> to go to next setup screen.

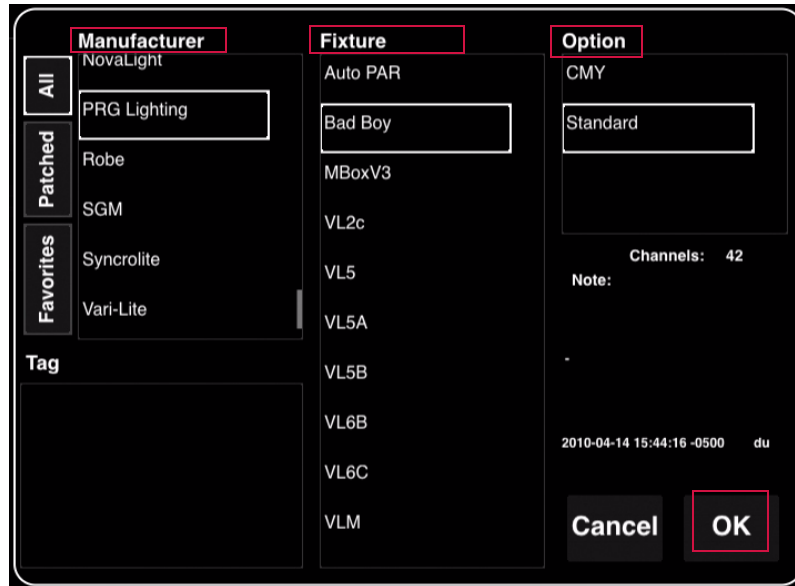

- Step 4. At fixture Patch screen, set options as required. Touch in field (such as channel number) and use keyboard to enter values, or use command-line entries.

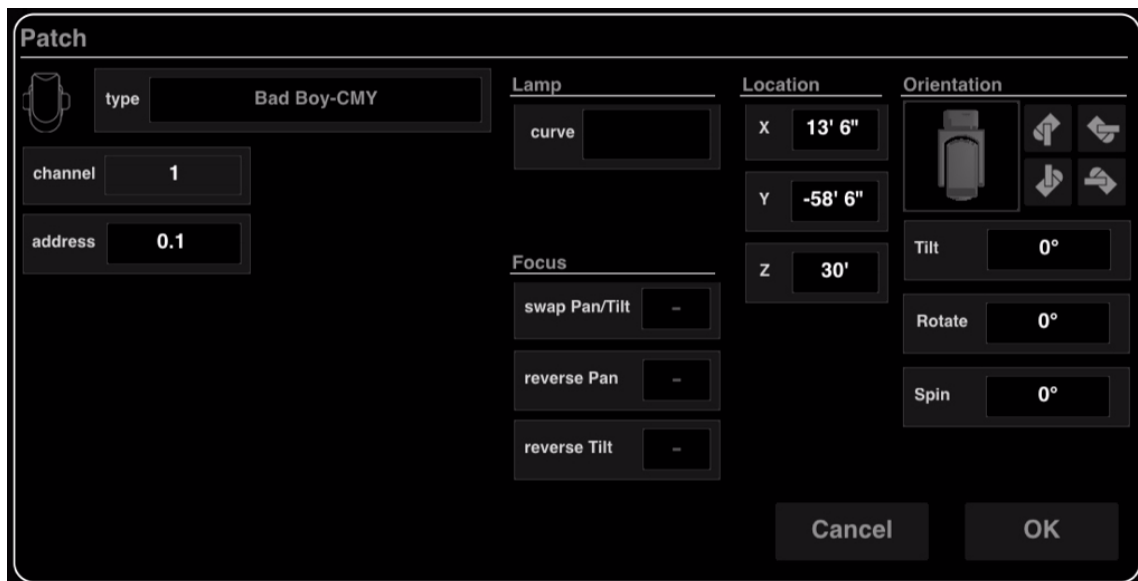

- + **Channel** - fixture's channel number.
- + **Address** - fixture's DMX universe/address. The DMX universe and address is expressed with dot notation, for example, the first address of universe 0 (A) would be 0.1.
- + **Lamp Curve** - specifies lamp dimmer curve setting (if applicable): Fast Bottom, Fast Top, Full at 1%, Hot Patch, IES Square Law, Slow Bottom, or Slow Top.
- + **Focus** - options for swapping and/or reversing pan and tilt.
- + **Location** - for use with 3D graphic features. Refer to "**X, Y, Z Locations**" on page 323.
- + **Orientation** - for use with 3D graphic features. Refer to "**3D Orientation**" on page 324.
- + **DMX Offset** - sets DMX offset channels between fixtures.

---

**Note:** When entering the universe/address, a decimal point must ALWAYS be used even if only one value is provided. For example if entering both values, the entry would be [*universe#.address#*]. If entering only the universe, the entry would be [*universe#.*]. If entering only the address, the entry would be [*.address#*].

---

## Entering Patch Commands

A patch command has the following format:

- + [Patch] [Chan] channel# [At] universe#.address#

If the channel number or DMX address is not included, the luminaire will be patched at the next channel or address. For example, to patch a luminaire at channel 10 as the first channel in DMX universe 2, enter the following command:

- + [Patch] [Chan] 10 [At] 2.1 [Enter]

A [Patch] [Enter] immediately after this will patch channel 11 with the same luminaire type at the next available DMX address in universe 2 (as long as channel 11 does not already exist).

Remember to change the luminaire type if necessary before pressing [Enter].

Luminaires are automatically located in the Plan View. The luminaire icons can be moved in the Plan View display while patch edit is enabled.

Patching a range of luminaires can be accomplished with the following syntax:

- + [Patch] [Chan] start# [Thru] end# [At] universe#.address#

## Patching Multi-Channels - Conventionals and Scrollers

Conventionals and scrollers can be patched to multiple DMX channels:

- + [Patch] [Chan] chan# [At] universe#.address# [Thru] address# + address#

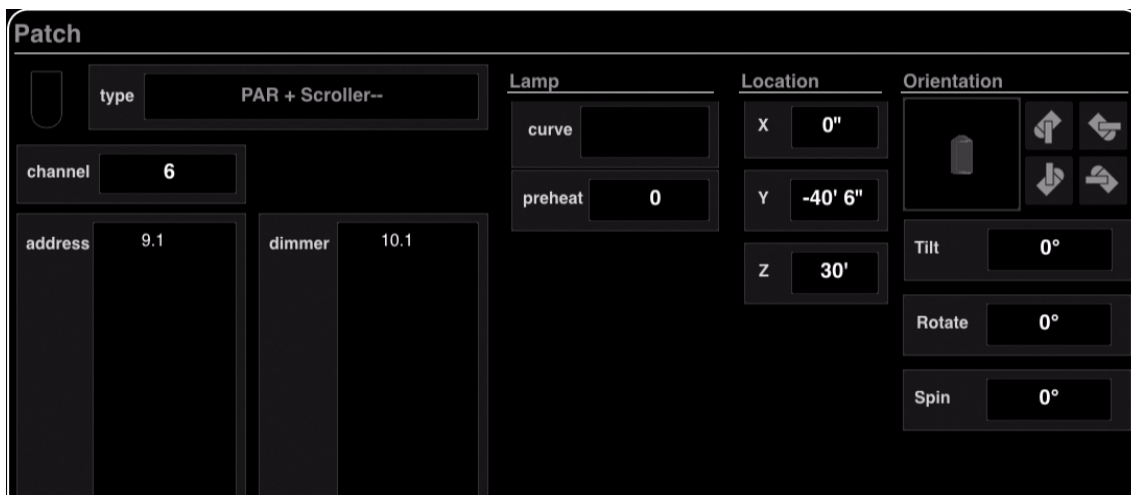



For example, to patch a conventional at channel 20, mapped to DMX universe 4, addresses 1-10, 12, and 15:

+ [Patch] [Chan] 20 [At] 4.1 [Thru] 10 [+] 12 [+] 15 [Enter]

Scrollers are patched in a similar way, but the [Dimmer] key is used to specify where the intensity channels are patched. For example, to patch a scroller at channel 30, mapped to DMX universe 5, channels 1-5, with intensity on DMX universe 6, channels 1-5:

+ [Patch] [Chan] 30 [At] 5.1 [Thru] 5 [Dimmer] 6.1 [Thru] 5 [Enter]

Five scroller type choices are provided in order to allow different scrollers to reference different gel strings.

+ Scrollers 1-4 - Four additional generic scroller types.

---

**Note:** Scroller color control is controlled by the Wheel encoder.

---

#### **To delete a DMX channel from conventional channels:**

+ [Patch] [Chan] chan# [At] [-] universe#.address# [Enter]

+ [Patch] [Chan] chan# [At] [-] universe#.address# [Thru] address# [Enter]

#### **LED Fixture Control**

The console supports LED fixtures where the light output is a function of 3-5 color channels, and no direct intensity control is provided. This type of fixture is controlled as follows:

+ The intensity control acts as a "master" of the color channels. If the intensity level is set at 50%, all color outputs will be reduced by 50%. This also applies to submaster and grandmaster control of intensity, i.e., the Blackout function will cause LED fixtures to go out.

This mode is enabled via a flag in the DMX fixture profile. (Refer to "**Profiles**" on page 26.)

#### **Patching Ranges**

It is possible to span to next universe when range patching new fixtures. The DMX start addresses will continue on to the next universe, until another patched channel is encountered.



## Patch Editing

Patch editing can be done using the command line or the Patch spreadsheet window.

---

**Important!** When entering the universe/address, a decimal point must ALWAYS be used even if only one value is provided. For example if entering both values, the entry would be [*universe#.address#*]. If entering only the universe, the entry would be [*universe#.*]. If entering only the address, the entry would be [*.address#*].

---

### Using Command Line

#### To edit a patched channel:

To edit a previously patched channel, enter [Patch] chan# to bring up the patch dialog for that channel. Here the luminaire type can be changed or patch options edited. The DMX address can also be changed using the usual [At] syntax.

You can also change the universe assignment for multiple luminaires with one command. For example, to move patched luminaires 1-14 to universe 20:

```
+ [Patch] [Chan] 1 [Thru] 14 [At] 20 [.]
```

#### To delete a patched channel:

To delete a channel from the patch:

```
+ [Patch] [Delete] [Chan] # [Enter]
```

#### To move patched channels:

To move patched channels to a different channel:

```
+ [Patch] [Move] [Chan] # [Thru] # [At] # [Enter]
```

#### To delete a DMX channel from conventional channels:

```
+ [Patch] [Chan] chan# [At] [-] universe#.address# [Enter]
```

```
+ [Patch] [Chan] chan# [At] [-] universe#.address# [Thru] address# [Enter]
```

### Using Patch Spreadsheet

The Patch window displays patch information in a spreadsheet format. Data can be viewed at any time and edited when patch editing is enabled. Refer to "[Patch Spreadsheet](#)" on page 33 for more information about this window.

### Using Plan View

With Patch enabled, double-click a fixture to bring up the edit dialog. Refer to "[Plan View](#)" on page 37 for more information about the Plan View.



## Patch Spreadsheet

The Patch window displays patch information in a spreadsheet format. Data can be viewed in different categories using the various tabs located at the top of the window. The data can be edited while in the Patch Edit mode.

To open the Patch window, select **Patch** from the **Setup** menu.

- + **Address** - The Address tab displays the data by address. A Tags column allows information to be added to each channel that can be used elsewhere in the console. (This can be useful to label floor lights, specials, etc.)

Setup	Operation	Data
Settings		
Ethernet		
Pairing		
System Config	⌘K	
Calibrate Screen		
Legacy Media Setup		
Media Server Setup		
Log	⌘L	
Plan View	⌘B	
Patch	⌘T	

Click column heading to sort by specific information type

Patch Mode Indicator (disabled)

Tags

channel	fixture type	univ	addr	DMX host	port	location	tags
375	VL3000S	L	321	Node 3	4		
376	VL3000S	L	349	Node 3	4		
377	VL3000S	L	377	Node 3	4		
378	VL3000S	L	405	Node 3	4		
379	VL3000S	L	433	Node 3	4		
380	VL3000S	L	461	Node 3	4		
401	BadBoy std	A	115	Node 1	1	Air	pod
402	BadBoy std	A	157	Node 1	1	Air	pod
403	BadBoy std	Q	1	Node 4	5	Floor	pod
404	BadBoy std	Q	43	Node 4	5	Floor	pod
405	BadBoy std	A	283	Node 1	1	Air	pod
406	BadBoy std	Q	85	Node 4	5	Floor	pod
407	BadBoy std	Q	127	Node 4	5	Floor	pod
408	BadBoy std	B	161	Node 1	2	Air	pod
409	BadBoy std	B	203	Node 1	2	Air	pod
410	BadBoy std	C	115	Node 1	3	Air	pod

- + **Settings** - The Settings tab displays settings such as swap, reverse, preheat, and dimmer curve. It also indicates which fixtures are assigned to specific media servers. (This is useful with the Media palette features. Refer to "[Controlling Media Servers](#)" on page 210.) When editing, some cells offer a pop-up menu, such as Dimmer Curve shown below.

Patch Mode Indicator (enabled)

channel	fixture type	swap	reverse	preheat	dimmer curve	media server
375	VL3000S					
376	VL3000S					
377	VL3000S					
378	VL3000S					
379	VL3000S					
380	VL3000S					
401	BadBoy std	✓			Fast Bottom	
402	BadBoy std	✓			Fast Bottom	
403	BadBoy std		pan		<none>	
404	BadBoy std		pan		Fast Bottom	
405	BadBoy std		tilt		Fast Top	
406	BadBoy std		pan & tilt		Full At 1%	
407	BadBoy std	✓			Hot Patch	
408	BadBoy std	✓			IES Square Law	
409	BadBoy std				✓ Slow Bottom	
410	BadBoy std				Slow Top	

- + **2D/3D** - The 2D and 3D tabs display the 2D/3D coordinate data.
- + **Notes** - The Notes tab displays any notations that may have been added to the fixtures.

## View Filtering

Two filtering options are available using the "Follow Auto" and "Set Local" filter buttons at the top of the window.

- + **Follow Auto** - filters the view to the Auto Display Filter, if it is enabled. In other words, if the **Follow Auto** button is enabled in the patch spreadsheet, and the Auto Display Filter is enabled, the patch spreadsheet will only show channels that are selected on the console.
- + **Set Local** - sets any current channel selection as a local view filter. In other words, whatever channels are currently selected will be the only channels shown in the window until the local filter is cleared.
  - To clear the local channel filter, clear the channel selection and click the **Set Local** button.

**Note:** The Auto and Local channel filters can work together to help filter the view based on a specific local filter and your selected auto filter.

channel	fixture type	univ	addr	DMX host	port	location	tags
375	VL3000S	L	321	Node 3	4		
376	VL3000S	L	349	Node 3	4		
377	VL3000S	L	377	Node 3	4		
378	VL3000S	L	405	Node 3	4		
379	VL3000S	L	433	Node 3	4		
380	VL3000S	L	461	Node 3	4		
401	BadBoy std	A	115	Node 1	1	Air	pod
402	BadBoy std	A	157	Node 1	1	Air	pod
403	BadBoy std	Q	1	Node 4	5	Floor	pod
404	BadBoy std	Q	43	Node 4	5	Floor	pod
405	BadBoy std	A	283	Node 1	1	Air	pod
406	BadBoy std	Q	85	Node 4	5	Floor	pod
407	BadBoy std	Q	127	Node 4	5	Floor	pod
408	BadBoy std	B	161	Node 1	2	Air	pod
409	BadBoy std	B	203	Node 1	2	Air	pod
410	BadBoy std	C	115	Node 1	3	Air	pod

## Dimmer Curves

### Overview

Dimmer curves provide better control of luminaire lamps. There are seven pre-programmed dimmer curves available: Fast Bottom, Fast Top, Full at 1%, Hot Patch, IES Square Law, Slow Bottom, and Slow Top.

#### To set dimmer curve from Patch window:

- Step 1. At **Setup** menu, select **Patch**. Window will open.
- Step 2. Enable patch by pressing (Patch) button on touchscreen. (It will be highlighted in yellow and display "Patch Editing" when the editing mode is active.)
- Step 3. For desired luminaire, click in Dimmer Curve column.
- Step 4. At drop-down menu, select dimmer curve configuration.

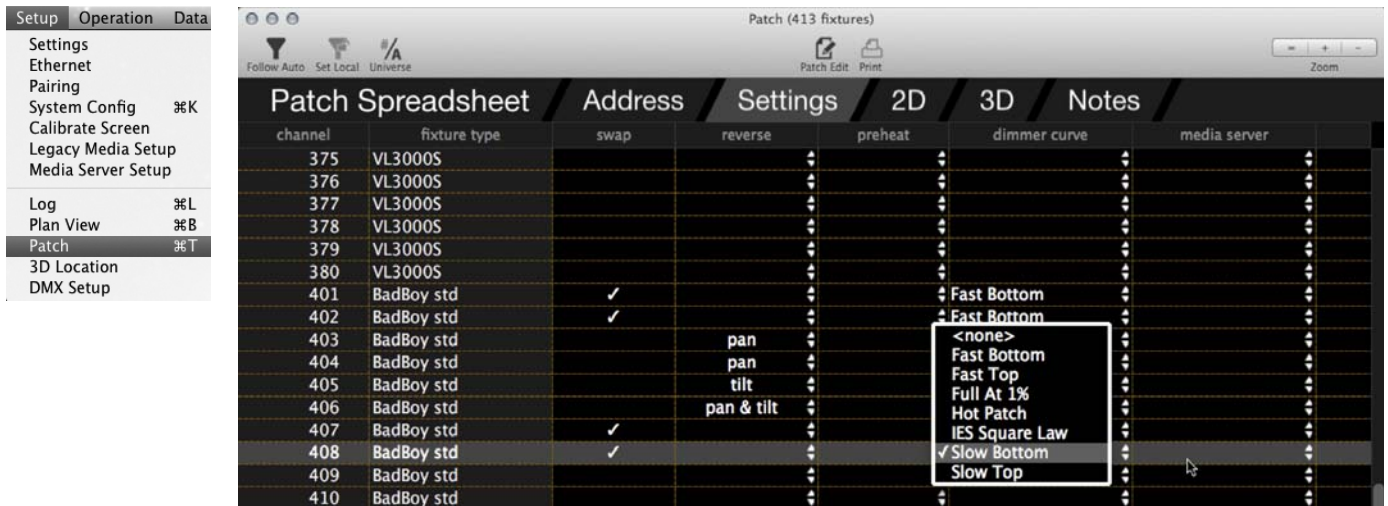

### Dimmer Curves Window

The Dimmer Curves window allows import, export, updating, and deleting of dimmer curves. Dates of dimmer curve files are shown for the console and for the show file. They may be copied easily from the show file to the console, or from the console to the show file.

#### To open Dimmer Curves window:

- Step 1. Select **Library/Dimmer Curves** from the **File** menu.

#### To move dimmer curve files:

- Step 1. At Dimmer Curve window, using trackpad, select dimmer curve to be moved.
- Step 2. Click on Copy Direction column between Console and Show File column. This column will change from a Bullet, to left arrow, or a right arrow. Keep clicking until desired direction is displayed.

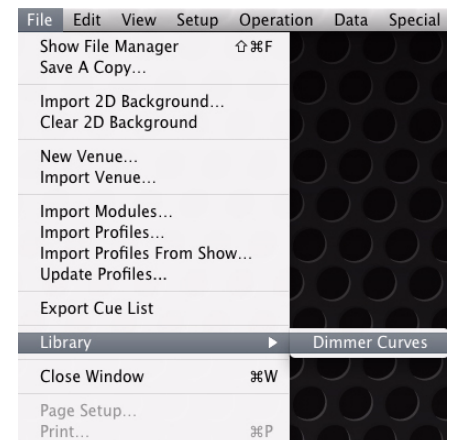

Step 3. To move file in the direction selected, click **Update** at bottom of window. This will copy the file in the direction selected. (This is a permanent change.)

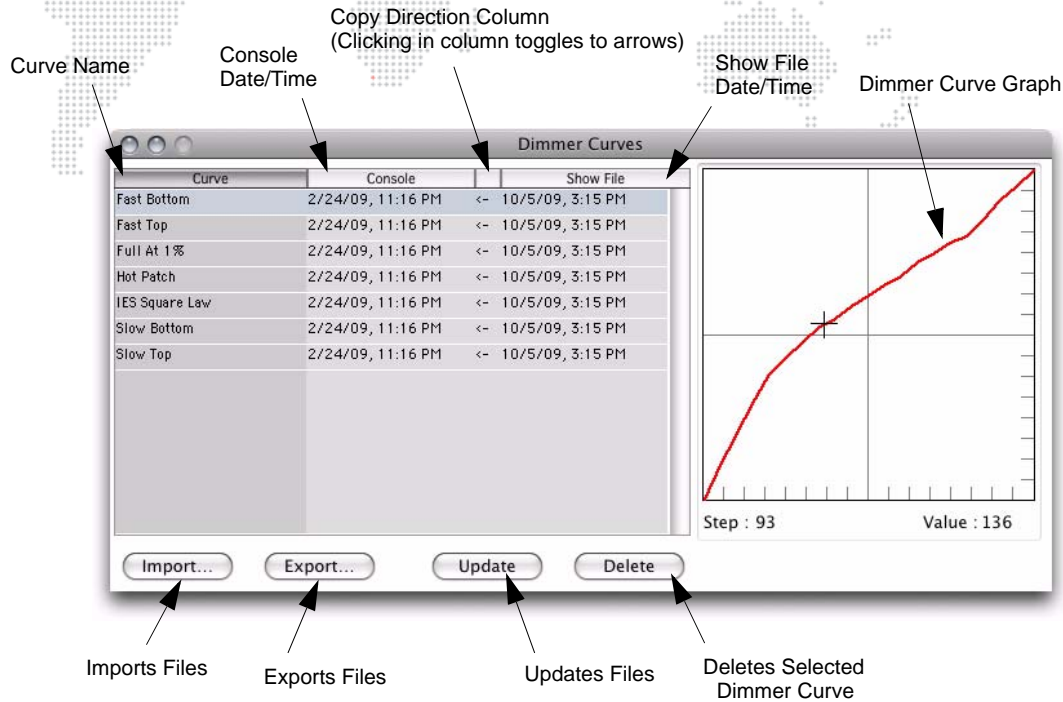

**To import dimmer curve files:**

New dimmer curve files can be imported into the dimmer curves window. Any comma-delimited file can be used as a dimmer curve file. A dimmer curve file can be created in any text or spreadsheet program. The file must contain intensity values for each step (0-255) separated by commas. For example, entries in a dimmer curve file look like: 0,0,1,1,2,3....

Step 1. At Dimmer Curve window, click **Import**.

Step 2. At Import Dimmer Curves window, select file location (disk or folder). Click on file name. Click **Open**.

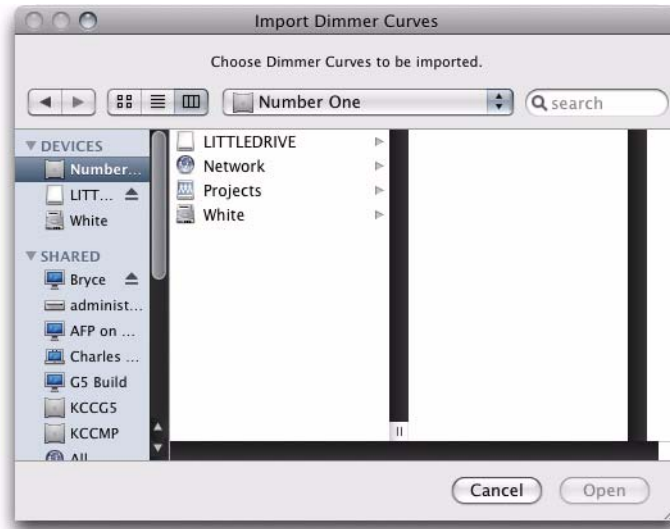

# PLAN VIEW

## General Plan View Operation

All patched luminaires are displayed in the Plan View. Operation of the Plan View can be done from the central touchscreen (available on the front panel - V476/V676 only) or the Plan View window (available from the **Setup** menu). The operations are basically identical whether you are using the touchscreen or software window.

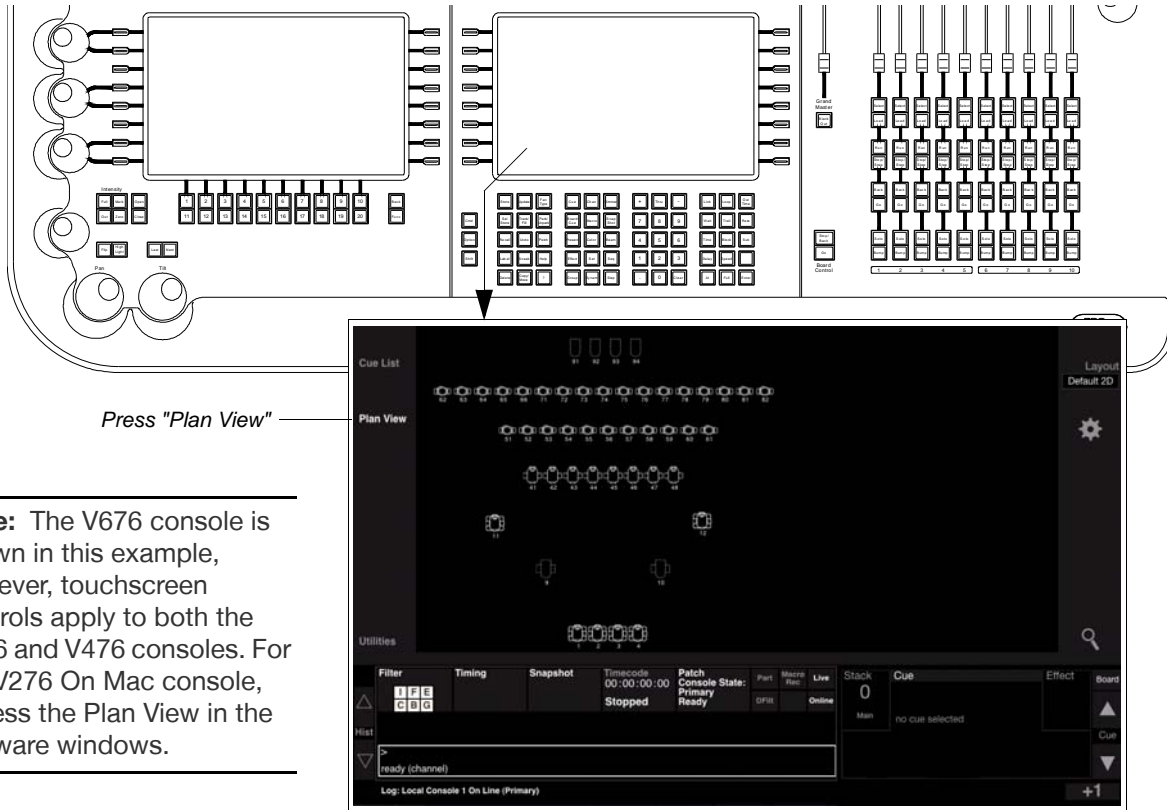

## Selecting Channels

The touchscreen allows for selecting luminaire icons (channels).

### To select/deselect single channels:

- + At Plan View, touch icon(s). Selected icons will be highlighted in orange.
- + Touch again to deselect.

Touch icon to select  
(Touch icon again to deselect)

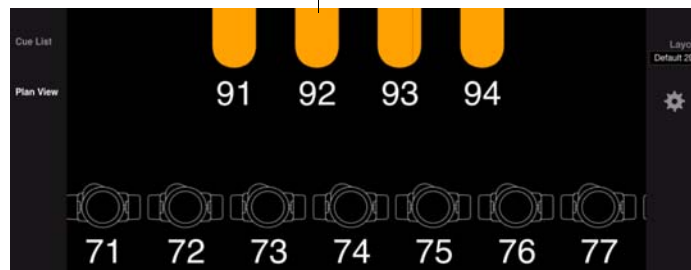

### To select/deselect multiple icons at once:

- + Using finger, drag box around icons you wish to select. Selected icons will be highlighted in orange.
- + Double-tap in Plan View to deselect all icons.
- + Press Cmd+A on the Mac keyboard to select all fixtures.

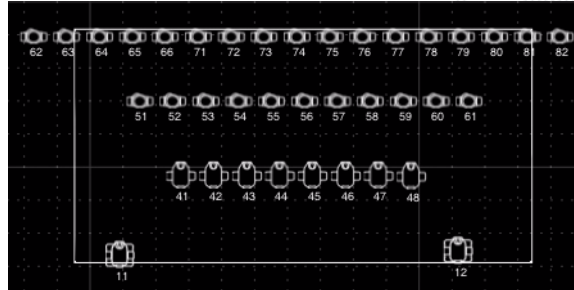

### Zoom

Selected areas can be zoomed using the zoom controls.

#### To zoom into a selected area:

- Step 1. At Plan View, touch white Zoom icon. (When Zoom mode is active, luminaire icons will not be selected when dragging to create a box.)
- Step 2. Using finger, drag box around desired zoom area.
- Step 3. Touch Zoom icon to toggle back and forth from zoomed area to wide view.

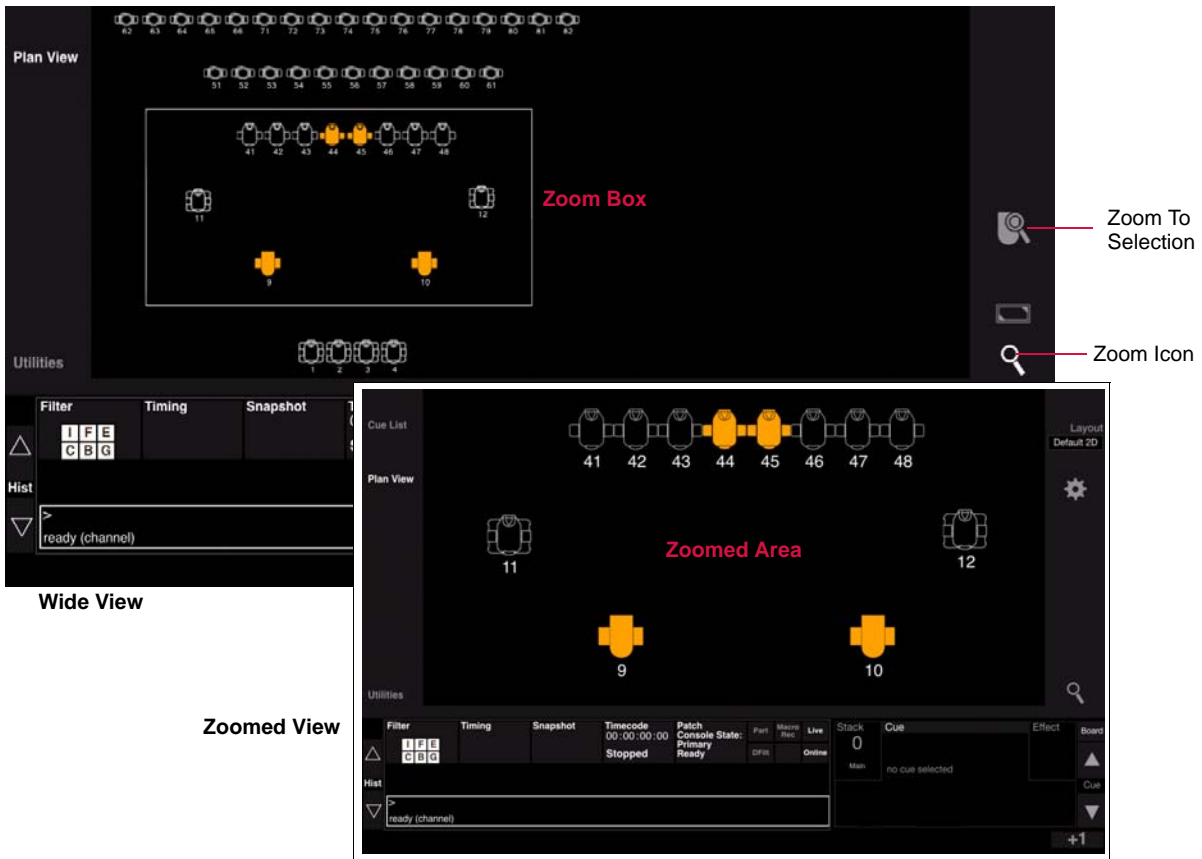

#### To create a new selection box:

- + While in Zoom mode, a new selection box can be created by dragging finger across a new area.

### To recenter selection box:

- + While in Zoom mode, tap in Plan View to recenter the selection box at any time.

### To zoom to selected fixture:

- + While in Zoom mode, select a fixture icon then press the Zoom-To-Selection icon.

## Pan

The view can be panned.

### To pan the view:

- + Press and hold [Shift] while dragging finger in Plan View. The viewing angle will be panned as you drag.

## Nudge and Align

When Patch Edit mode is enabled, several new action icons appear at the right of the Plan View.

### To nudge a fixture(s):

- Step 1. Enter Patch Edit mode by pressing Patch Editing button.
- Step 2. Select fixture icon and use nudge arrows to move fixture. The arrows will be displayed at the bottom of the layout when fixtures are selected. (Selected fixtures can be repeatedly nudged by holding down the nudge arrows.)

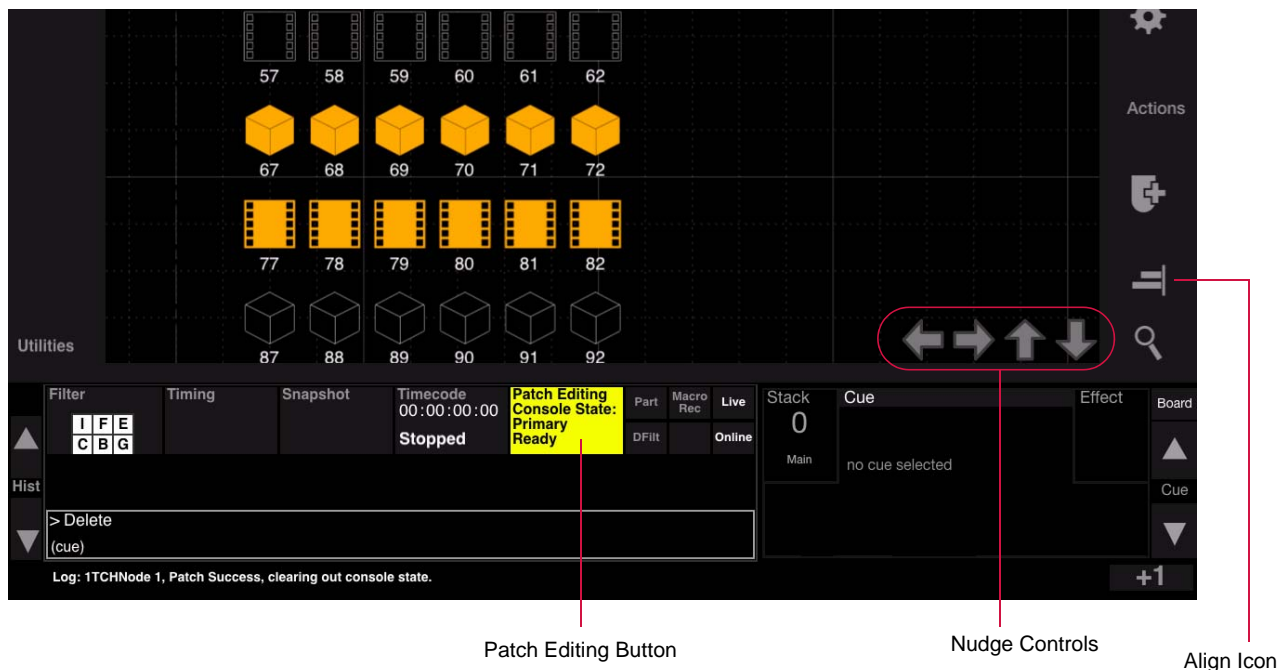

### To align fixtures:

When multiple fixture icons are selected, the Align icon will be displayed at the right of the Plan View.

- Step 1. Enter Patch Edit mode by pressing Patch Editing button.
- Step 2. Select multiple fixtures.
- Step 3. Press Align icon to bring up alignment options.

## Plan View Settings

Various Plan View options can be set using the Layout Settings screen.

- + **Canvas** - sets options for the Plan View size, dimensions, and origin.
- + **Grid** - sets Plan View grid size, visibility, snap option.
- + **Display** - sets the attribute which will be displayed under the fixture icon in the Plan View. By default, the channel numbers are displayed, but this can be changed using the Attribute pop-up menu.

### To configure Plan View settings:

Step 1. At Plan View, press the gear button to open Layout Settings screen.

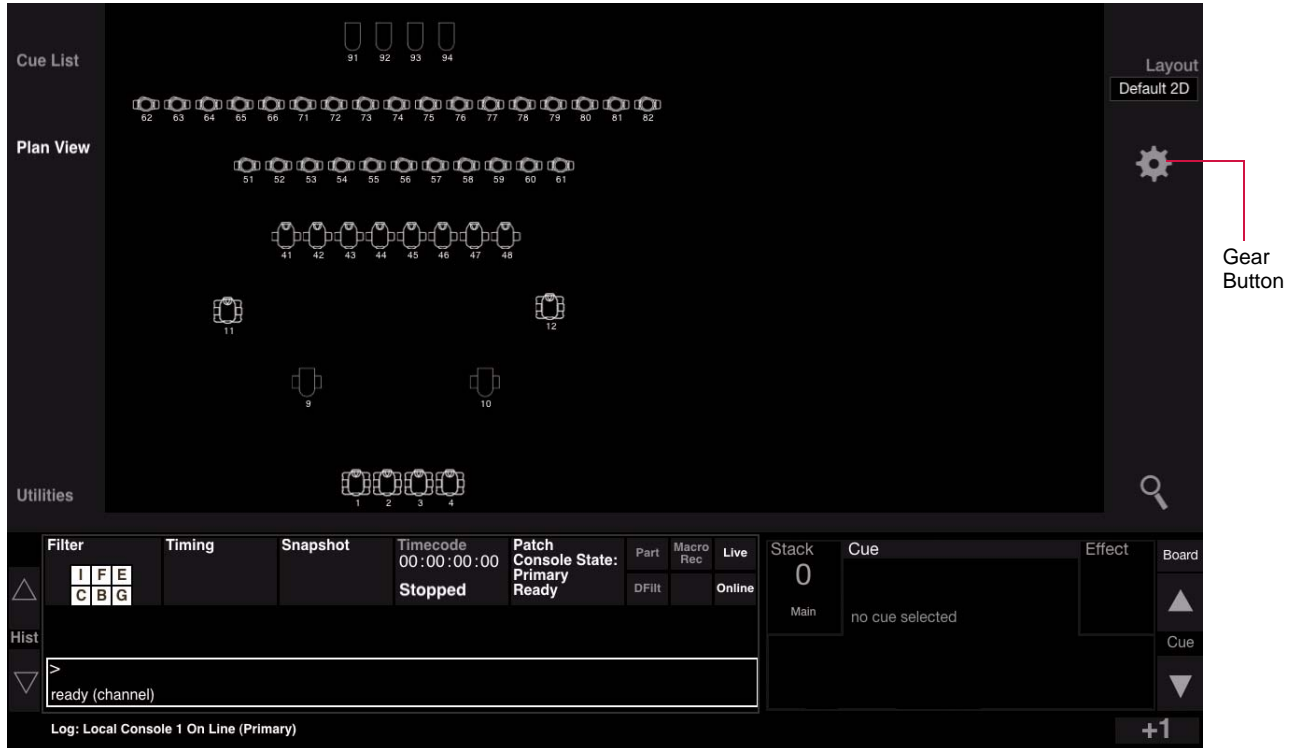

Step 2. At Layout Settings screen, configure settings as required and press <Done>.





## Plan View Layouts

The Plan View can be displayed in either a 2D or 3D layout, or custom layouts may be created.

### 2D/3D Layouts

The Plan View includes two pre-configured layouts which will display the fixtures according to either 2D or 3D data. (The 2D Layout is the default.)

#### To change layout:

- Step 1. At Plan View, press <Layout>.
- Step 2. At layout selection menu, select new layout. (If custom layouts have been created, these will be included in the list.)

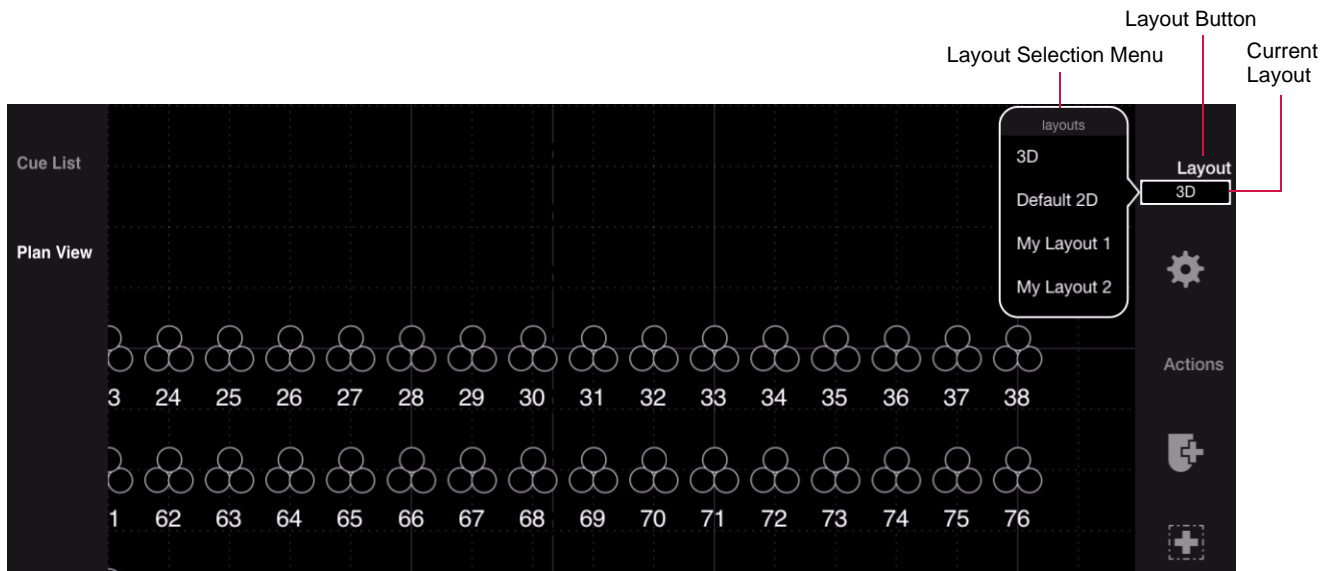

### Custom Layouts

Custom layouts can be added to the Plan View beyond the included 2D and 3D layouts.

#### Guidelines:

- + Each custom layout can have its own settings.
- + Fixtures may be hidden from custom layouts as desired.
- + When creating a new layout, the console starts with the current default 2D Layout. This means that if the 2D Layout has been changed, then it will be reflected at the starting point of the new custom layout.
- + If a new fixture is patched on a custom layout, the fixture will be hidden on any other custom layout that has hidden fixtures. In other words, it will only be visible on the layout in which it is patched and on any custom layouts that do not hide any fixtures.
- + Manipulating layouts places the console in Patch Edit mode.

**To create a custom layout:**

- Step 1. At console's central touchscreen, press <Plan View>.
- Step 2. Press gear icon to open Layout Settings window. At window, press New icon to generate a new layout.
- Step 3. Adjust Layout Settings as required.
- Step 4. Press <Done> to save configuration and close window.

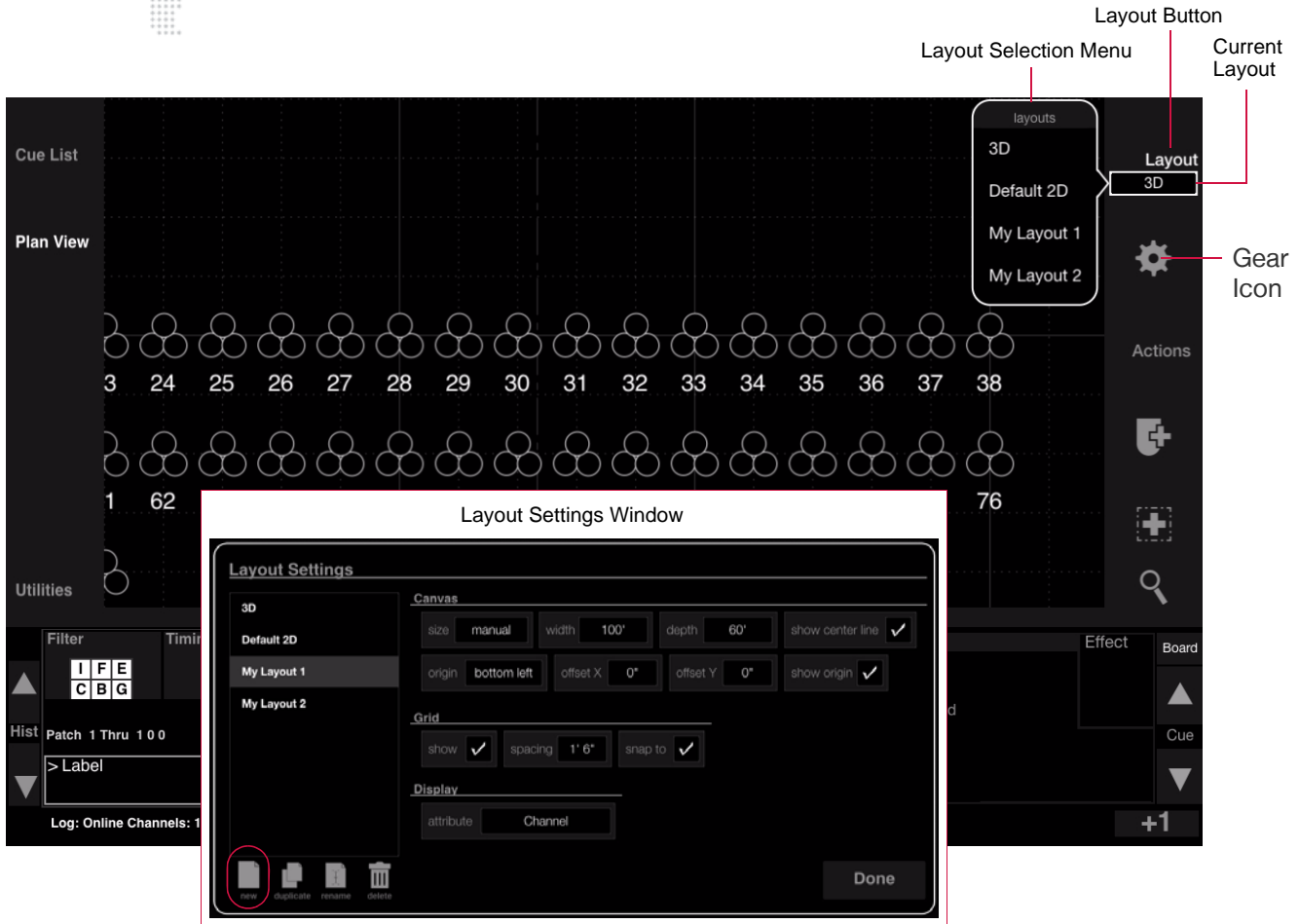

**To label a custom layout:**

- Step 1. Press <Layout> to open layout selection menu.
- Step 2. Press and hold [Label] while touching a layout name.
- Step 3. At keypad, enter alpha/numeric label and press <Enter>.

**To delete a custom layout:**

- Step 1. Press <Layout> to open layout selection menu.
- Step 2. Press and hold [Delete] while touching a layout name.

**To edit a layout:**

- Step 1. Press gear icon to open Layout Settings window.
- Step 2. At left column, select a layout.
- Step 3. Adjust settings as required.

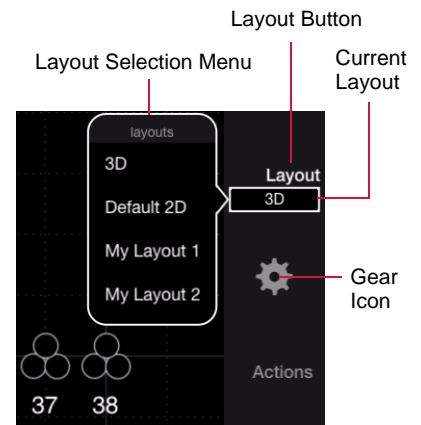

Step 4. Press <Done> to save configuration and close window.



**To switch between layouts:**

- Step 1. Press <Layout> to open layout selection menu.
- Step 2. At menu, select a new layout. Layout will load into Plan View window.

---

**Caution:** If another layout is opened without first saving the patch edit, any changes to the previous layout will be lost. (Save patch edits by disabling the patch and following the save dialog.)

---

## Plan View Actions (Show/Hide)

Various Plan View options are available from the Actions menu. These options can be used to apply channel selection and show/hide fixtures in layouts.

- + **Apply Channel Selection** - takes current channel selection and makes it the patch selection. This only works when the Plan View is in Patch Edit mode.
- + **Select All/Visible/Hidden** - these options select either all, the visible, or the hidden channels in the current layout.
- + **Hide Channels** - hides the currently selected channels in the layout. This action only works with custom layouts and will be grayed out when the standard 2D or 3D layouts are active.
- + **Show Channels** - shows (unhides) the currently selected channels in the layout. This action only works with custom layouts and will be grayed out when the standard 2D or 3D layouts are active.

---

**Note:** Hidden fixtures only show up in Patch Edit mode. They are displayed in a lighter outline to indicate that they are currently in the hidden state.

---

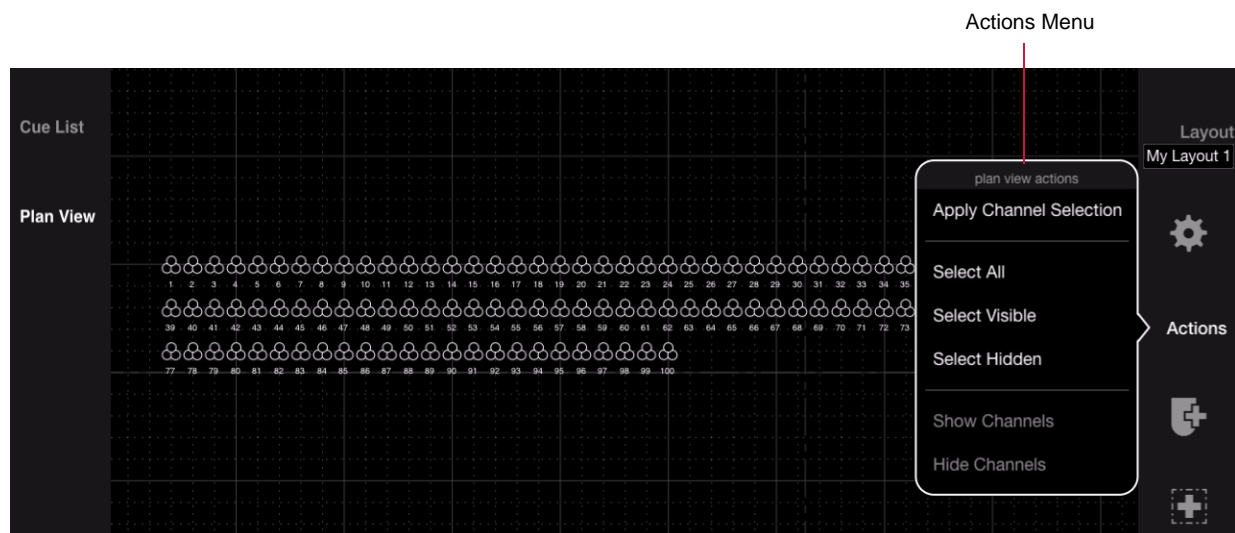

### To apply channel selection:

- Step 1. Select one or more channels on the console.
- Step 2. Press <Actions> and choose "Apply Channel Selection."

### To select channels in Plan View:

- Step 1. Press <Actions>.
- Step 2. Choose "Select All," "Select Visible," or "Select Hidden" as required. The corresponding channels will be selected in the Plan View.

### To hide channels:

- Step 1. Press <Layout> and choose a custom layout.
- Step 2. Select one or more channels in the layout to hide.
- Step 3. Press <Actions> and choose "Hide Channels."

### To show (unhide) channels:

- Step 1. Press <Layout> and choose a custom layout.
- Step 2. Select one or more hidden channels in the layout.
- Step 3. Press <Actions> and choose "Show Channels."

## Plan View Regions

The Regions feature allows rectangular areas to be drawn on the Plan View for use as organizational tools. The region contains meta data for the included fixtures so that they can easily be added to groups, presets, cues, etc. based on their location. It also provides an easy method for selecting fixtures within a region.

### Guidelines:

- + Multiple regions may be created.
- + Regions can overlap.
- + Regions can be labeled and deleted as desired.
- + Regions are exclusive to the layout on which they are drawn.

### To create a region:

- Step 1. At console's central touchscreen, press <Plan View>.
- Step 2. Press <Layout> and choose a target layout for the region using selection menu.
- Step 3. Enter Patch Edit mode by pressing Patch Editing button.
- Step 4. Press region tool icon. (It will highlight.)
- Step 5. At Plan View, draw a region by dragging finger until the desired size box is created.

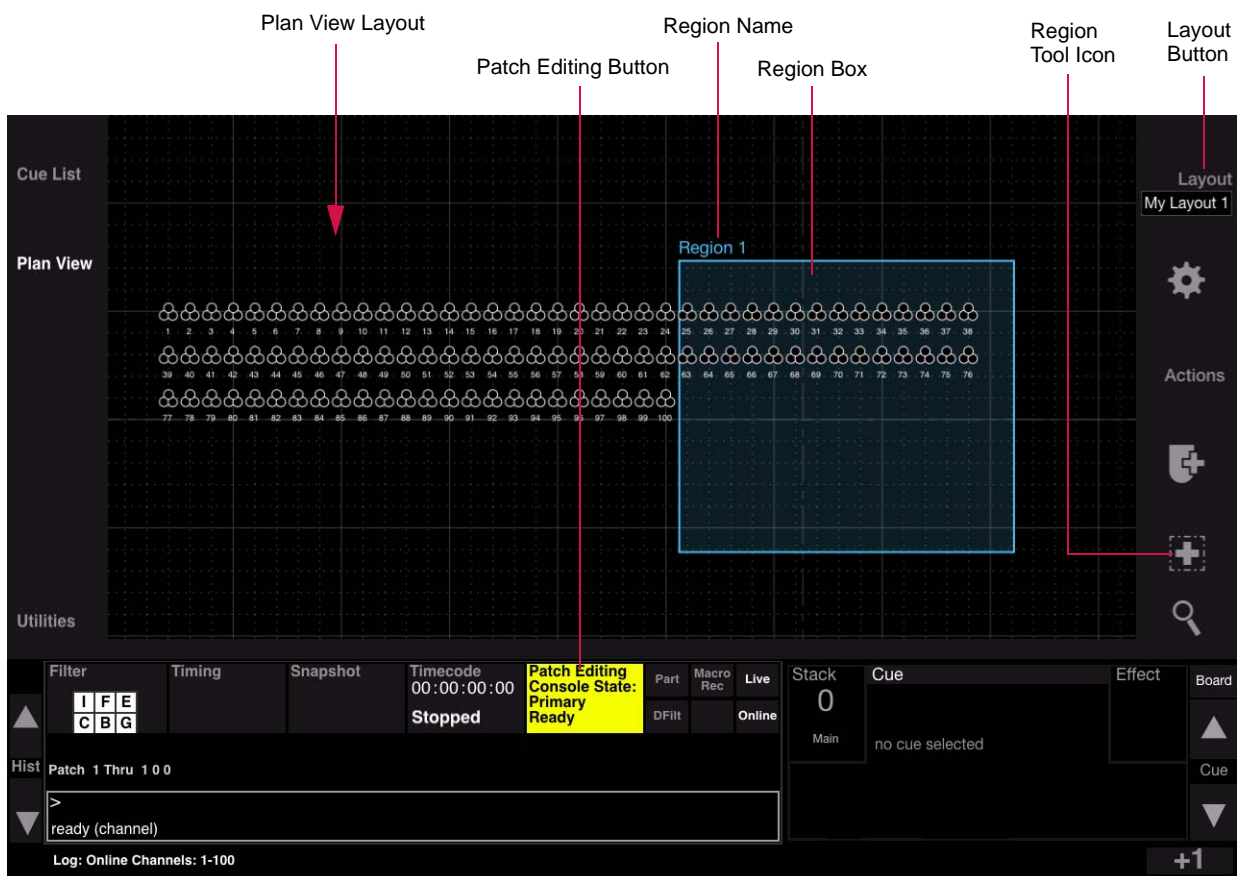

### To label a region:

- Step 1. Press and hold [Label] while touching the region's name on the Plan View.
- Step 2. At keypad, enter alpha/numeric label and press <Enter>.

### To edit a region:

- Step 1. Touch region name. (Name will be highlighted in a box and the region outline will change to a dashed line.)
- Step 2. To move, drag box's label to a new location. Or, use the four arrows at the bottom of the Plan View to nudge the box right, left, up, or down.
- Step 3. To resize, drag bottom-right corner (enlarge or reduce).
- Step 4. Double-tap outside of box to turn off editing mode.

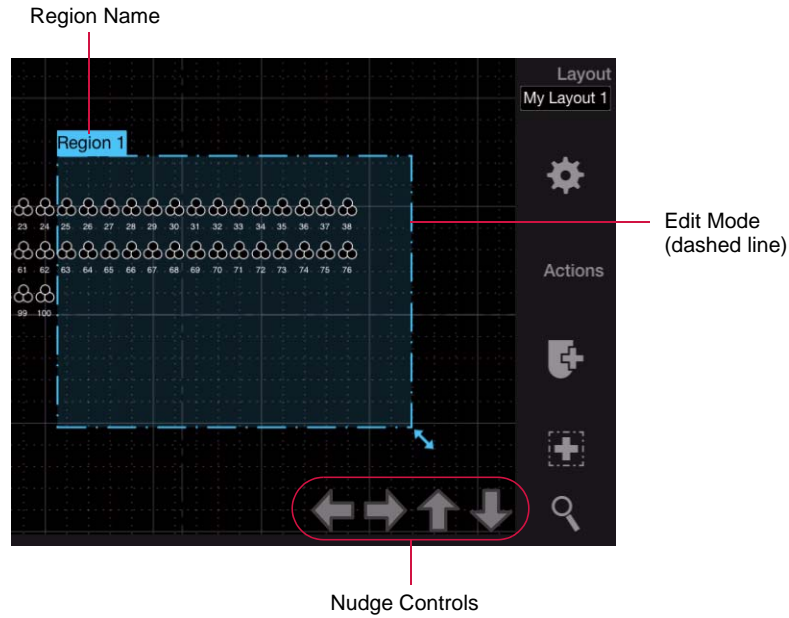

### To delete a region:

- + Press and hold [Delete] while touching the region's name on the Plan View.

### To select/deselect fixtures in a region:

- Step 1. Be sure console is not in Patch Edit mode.
- Step 2. Open layout which contains the region. (2D, 3D, custom layout, etc.)
- Step 3. Touch region inside box. All fixtures in that region will be selected.
- Step 4. Touch again to deselect.

## Patch Fixtures in Plan View

An Add Fixture icon is available in the Plan View while patch is enabled. This feature provides an alternate method for patching fixtures that sets the 2D and/or 3D location when the fixture is placed.

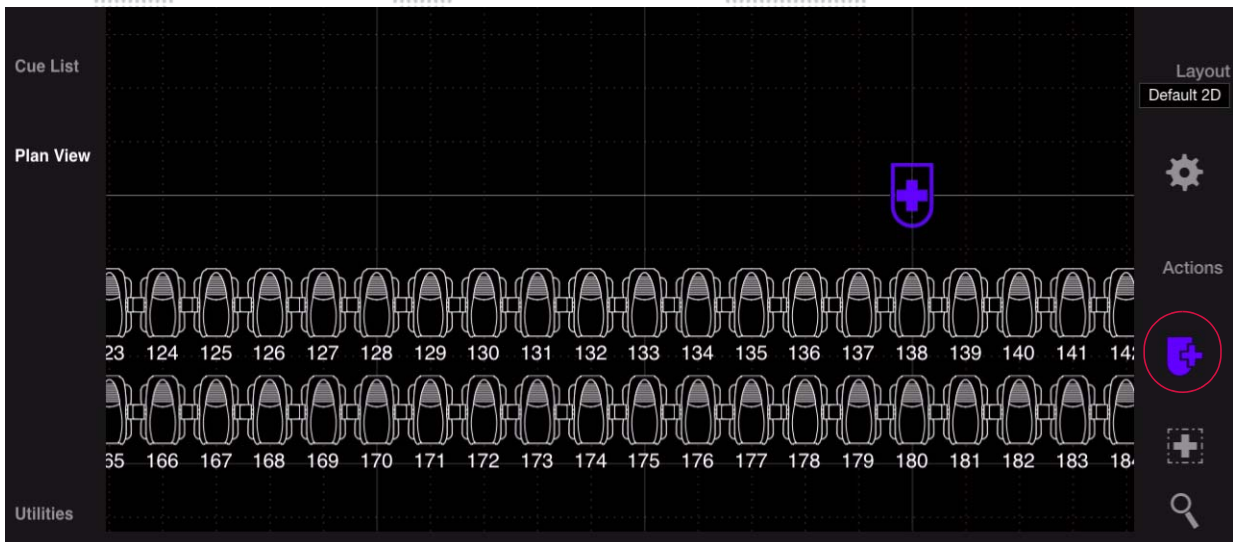

### To patch a fixture using the Add Fixture icon:

- Step 1. Make sure patch is enabled. (Refer to "Enabling/Disabling Patch Editing" on page 28.)
- Step 2. Press Add Fixture icon. (It will highlight.)
- Step 3. Touch within the Plan View area to place fixture (at the touched location). The placement icon will remain to show the position of the next fixture patched from the command line.

### Shortcut:

Pressing and holding [Option] while placing the fixture will patch another fixture of the same type with the next channel number and DMX address.



## Edit Fixture From Plan View

With Patch enabled, double-click a fixture to bring up the edit dialog.



**Notes**





### 3.

## MANUAL CONTROL

This chapter provides instructions for controlling luminaires in order to build cues.

- + CHANNEL SELECT
- + LAMP CONTROL
- + ENCODER CONTROL
- + KEYPAD CONTROL
- + LUMINAIRE STATUS

# CHANNEL SELECT

## Overview

When the patch was defined in the previous chapter, each luminaire was assigned to a control channel (refer to "Patch Overview" on page 26). Selecting the channel will give you control of the luminaire's parameters in order to build cues or to store as groups of channels, presets, palettes, etc.

In addition to the methods of channel selection covered in this section, channels can also be selected in the Plan View and 3D Graphic windows. However, these methods are covered along with the respective topics elsewhere in this manual:

- + For selecting channels via the Plan View, refer to "Plan View" on page 37.
- + For selecting channels via the 3D Graphic software window, refer to "Using 3D Graphic Window" on page 325.

## Selecting Channels

Channel numbers can be selected or deselected from the Channel Select panel, Channel Select window, or command-line keypad. When selecting channels, the channels will highlight in the window, on the Channel Select panel and their respective icons will be highlighted in the Plan View.

### From Channel Select Panel (V476/V676 Only)

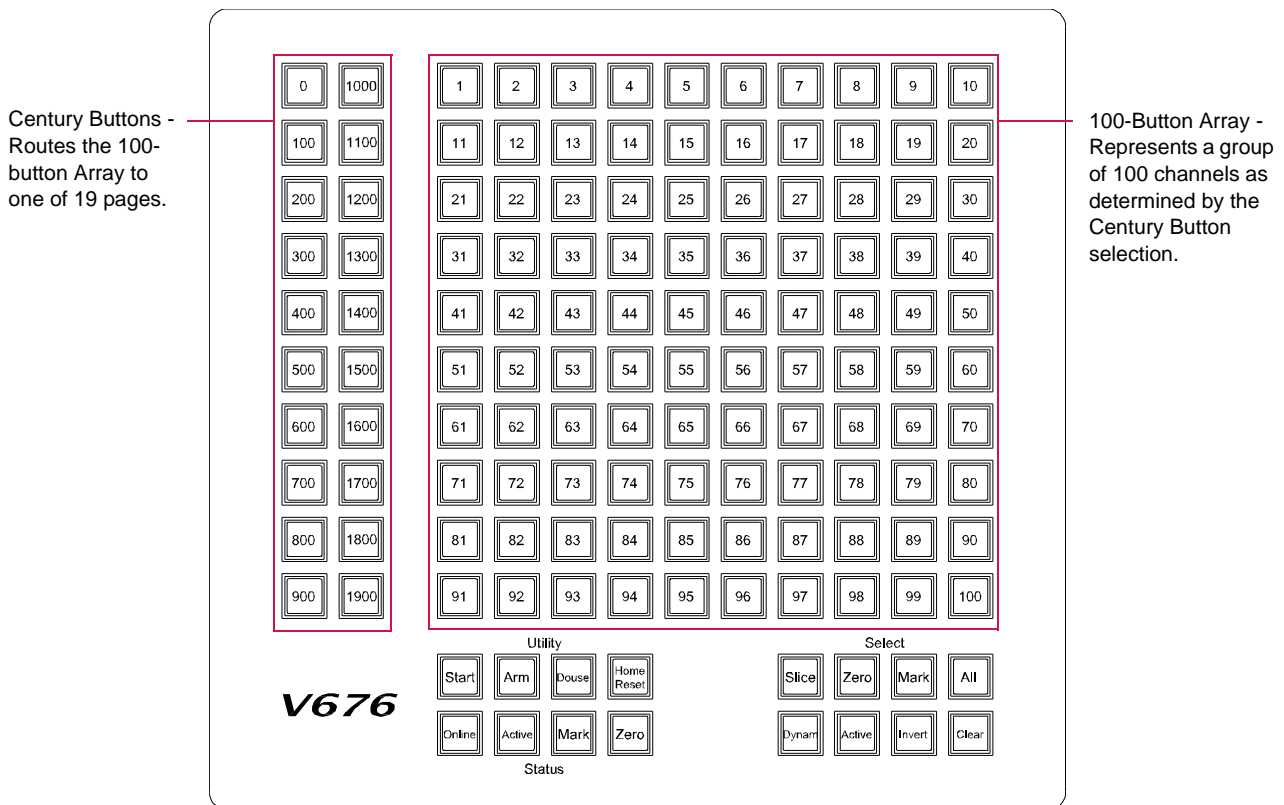
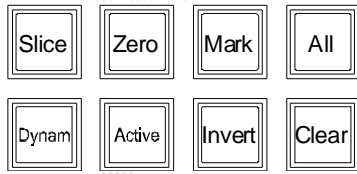

Figure 3-1: External Channel Select Panel

**Note:** When selecting channel numbers greater than 2000, this can only be done via command-line keypad and groups, since the Channel Select panel only accommodates 2000 channels in its hard buttons.

Eight select buttons are available for simplifying channel selection:



- + [Slice] - *for future use.*
- + [Zero] - selects all channels in a *zero\** state.
- + [Mark] - selects all *marked\** channels.
- + [All] - selects all patched channels.
- + [Dynam] - *for future use.*
- + [Active] - selects all channels with *active\** luminaires.
- + [Invert] - deselects currently selected channels and selects all other patched channels.
- + [Clear] - clears all channel selections.

Four status mimic buttons are available. These buttons highlight as indicators rather than as a selection tool:

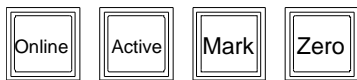

- + [Online] - indicates all online luminaires.
- + [Active] - indicates all luminaires that are *active\**.
- + [Mark] - indicates all luminaires that are *marked\**.
- + [Zero] - indicates all luminaires that are in a *zero\** state.

Four luminaire utility buttons are also available. These apply only to selected luminaires:

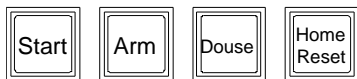

- + [Start] - starts lamp for all selected arc luminaires with remote start capability.
- + [Douse] - douses lamp for all selected arc luminaires with remote start capability. Press and hold [Arm] while pressing [Douse] to send the douse command.
- + [Arm] - must be held along with [Douse] or [Home/Reset] to complete the command.
- + [Home/Reset] - dual action button.  
[Home] sets all parameter timing to zero and clears any intensity Mark or Zero states. Press and hold [Arm] while pressing [Home/Reset] once.  
[Reset] recalibrates luminaires. Press and hold [Arm] while pressing [Home/Reset] twice.  
Also refer to "**Home / Reset (Recalibration)**" on page 59.

\* Active - luminaires with intensity greater than zero (1-100%).  
Marked - luminaires with an intensity state of "marked."  
Zero - luminaires with an intensity state of zero ("hard zero", 0% level).  
(For a more in-depth explanation, refer to "**Intensity States**" on page 140).



**Select a single channel (or multiple single channels):**

Step 1. At Century Buttons, press [0] through [1900] as required. Button will light.

Step 2. At 100-Button Array, press button of channel number to be selected, [1] through [100]. Button will light.

Step 3. To select multiple single channels, continue selecting channels (channel selections "pile on").

*Example:*

To select channel 521, press the page [500] button and then press [21] on the 100-button array.

**Select a range of channels:**

Step 1. At Century Buttons, press [0] through [1900] as required. Button will light.

Step 2. At 100-Button Array, press button of first channel number to be selected. Then, while holding down first button, press button of last number in range. First and last buttons will light, as will all those in-between.

**Select channels on multiple pages:**

Step 1. At Century Buttons, press [0] through [1900] as required. Button will light.

Step 2. At 100-Button Array, press button of first channel number to be selected. Then, while holding down first button, press button of last number in range. First and last buttons will light, as will all those in-between.

Step 3. Press next required page ([0] through [1900]). First page number button will flash to show that channels are selected on that page.

Step 4. Press buttons for channels to be selected.

Step 5. Repeat Steps 3 through 5 as required.

**Deselect a single channel (or multiple single channels):**

+ Press any selected channel button(s) to deselect.

**Deselect a range of channels:**

+ Press button of first selected channel button to be deselected. Then, while holding down first button, press button of last number in range. The range will be deselected.

**Tip** ⇨ To select a single channel and deselect all others, double-click on any channel button.

---

**Note:** The *order* of channel selection is retained when storing a Group. Refer to "**Ordered Groups**" on page 131.

---

## From Channel Select Window

Selecting channels from the Channel Select window is similar to selecting channels in the Channel Select panel.

- + Open the window by selecting **Channel Select** at the **Operation** menu.
- + Click the pin icon at the top-right corner to keep the Channel Select on top of other windows. (When pinning is active, the pin icon will turn from gray to white.)

[1000] Millennium Button - Routes control to first 1000 channels when not selected / routes control to second 1000 when selected.

Operation	Data	Special
Cue Sheet		
Board Cue Sheet		
Plan View		⌘B
3D Graphic		⌘G
Luminaire Status		⌘S
Tracking Changes		⌘S
Intensity		⌘I
Timecode		
Palettes		
Channel Select		
Century Palette		
Timing/Filter Display		
276 Display		
Command HUD		
Submaster HUD		
Encoder HUD		
Pan/Tilt Control		
X/Y Control		⌘;
		⌘'

The Channel Select window features a grid of 100 buttons (0-99) and several control buttons. The buttons are arranged in a 10x10 grid. The control buttons are located at the top of the window. The Millennium button (0) is highlighted in white.

Century Buttons (0-900) - Routes the 100-button array to one of ten pages

100-Button Array - Represents a group of 100 channels as determined by the millennium and century buttons



Six buttons are available for simplifying channel selection:

- + [Clr] - clears all channel selections.
- + [All] - selects all patched channels.
- + [Inv] - (Invert) deselects currently selected channels and selects all other patched channels.
- + [Act] - selects all channels with *active*\* luminaires.
- + [Mar] - selects all *marked*\* channels.
- + [Z] - selects all channels in a *zero*\* state.

Four status mimic buttons are available. These buttons highlight in purple as an indicator rather than as a selection tool:

- + [Online Status] - indicates all online luminaires.
- + [Active Status] - indicates all luminaires that are *active*\*.
- + [Marked Status] - indicates all luminaires that are *marked*\*.
- + [Z Status] - indicates all luminaires that are in a *zero*\* state.

Four luminaire utility buttons are also available:

- + [Arm] - must pressed first (it will latch on) before pressing [Douse] or [Home/Reset] to complete those commands. (This prevents accidental dousing or reset actions.)
- + [Start] - starts lamp for all selected arc luminaires with remote start capability.
- + [Douse] - douses lamp for all selected arc luminaires with remote start capability. Press [Arm] then press [Douse] to send the douse command.
- + [Home/Reset] - dual action button.  
 [Home] sets parameters to defaults. Press [Arm] then press [Home/Reset] once to send the home command.  
 [Reset] recalibrates luminaires. Press a [Arm] then press [Home/Reset] twice to send the reset command.  
 Also refer to "**Home / Reset (Recalibration)**" on page 59.

\* Active - luminaires with intensity greater than zero (1-100%).  
 Marked - luminaires with an intensity state of "marked."  
 Zero - luminaires with an intensity state of zero ("hard zero", 0% level).  
 (For a more in-depth explanation, refer to "**Intensity States**" on page 140).



**Select a single channel (or multiple single channels):**

- Step 1. Select [1000] as required.
- Step 2. Select [0] through [900] as required. Button will light.
- Step 3. Select button of desired channel. Button will light.
- Step 4. To select multiple single channels, continue selecting buttons of channels to add (selections "pile on").  
*Example:* To select channel 521, ensure that [1000] button is not active, select the page [500] button and then select [21] on the 100-button array.

**Select a range of channels:**

- Step 1. Select [1000] as required.
- Step 2. Select [0] through [900] as required. Button will light.
- Step 3. Select button of first channel. Then, while holding mouse button down, drag across range of channels (mouse) *or* drag finger across range of channels (touchscreen).

**Select channels on multiple pages:**

- Step 1. Select [1000] as required.
- Step 2. Select [0] through [900] as required. Button will light.
- Step 3. Select required channels.
- Step 4. Select next required page ([0] through [900]). First page button will be dimly highlighted to show that channels are selected on that page.
- Step 5. Select required channels on new page.
- Step 6. Repeat Steps 4 and 5 as required.

**Deselect channels:**

- + Press any selected channel button(s) to deselect.

---

**Note:** The *order* of channel selection is retained when storing a Group. Refer to "**Ordered Groups**" on page 131.

---

## From Keypad

Channels may also be selected using the command-line keypad, available on the front panel.

### Guidelines:

- + Any combinations of [ + ], [ - ], and [Thru] are allowed.
- + Pressing [Enter] completes the channel selection.
- + Because the keypad always defaults to channel entry mode, use of the [Chan] (channel) button is optional.

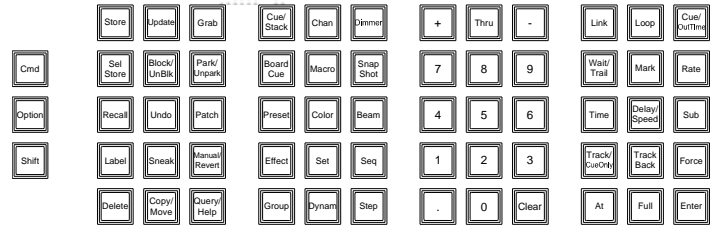

```
>  
ready (channel)
```

### Select a single channel:

- + <Chan> [n] [Enter].

### Select multiple channels:

- + <Chan> [m] [+ ] [n] [Enter].

### Select a range of channels:

- + <Chan> [m] [Thru] [q] [Enter].

### Select multiple channels including a group:

- + <Chan> [m] [+ ] [Group] [n] [Enter].

### Select all active channels:

- + [Chan] [Enter].

### Other examples:

- + <Chan> [m] [+ ] [s] [Thru] [w] [Enter].
- + <Chan> [m] [+ ] [s] [Thru] [w] [-] [t] [Enter].

### [Clear]

[Clear] functions as a backspace key when used during command-line construction. For example, <Chan> [n] [Thru] [t] [Clear] [s] [Enter] results in the selection of channels n thru s. When [Clear] is used after an [Enter] (fully terminated command line), the command line is cleared.

The only thing that clears a syntax error on the command line is [Clear]. Any other keypad entry is ignored until the error condition is cleared.

**Tip** ⇨ Holding down [Clear] will clear an entire unterminated command line.

---

**Note:** The *order* of channel selection is retained when storing a Group. Refer to "**Ordered Groups**" on page 131.

---



## [Next] and [Last]

The [Next] and [Last] buttons will step through all channels.

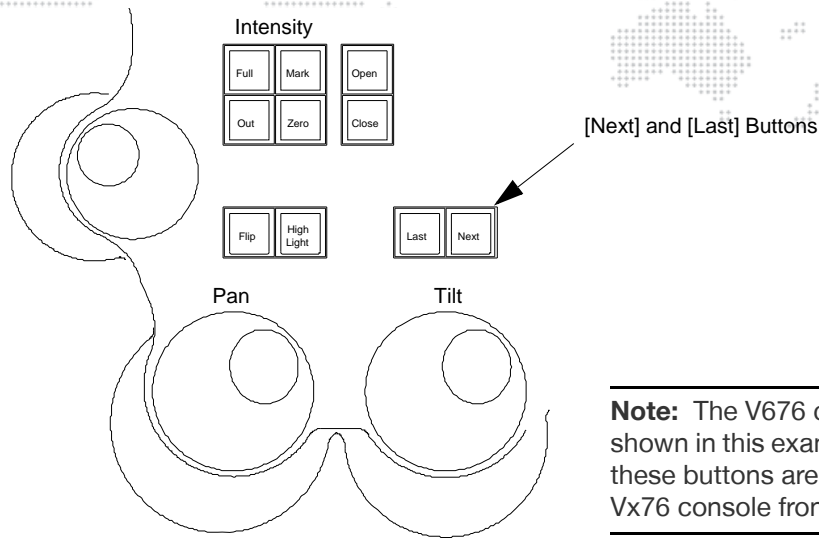

---

**Note:** The V676 console is shown in this example, however, these buttons are found on all Vx76 console front panels.

---

Figure 3-2: Next and Last Buttons

- + [Next] - increments the channel selection by one.
- + If a single channel were selected (either with the keypad or the 100 button array), pressing [Next] will increment the channel selection by one. If a range of channels is selected, the first press of [Next] will select the first channel in that range. Subsequent presses will increment the channel selection by one, but will not select a channel outside the range.
- + [Last] - decrements channel selection by one.
- + If a single channel were selected (either with the keypad or the 100 button array), pressing [Last] will decrement the channel selection by one. If a range of channels is selected, the first press of [Last] will select the last channel in that range. Subsequent presses will decrement the channel selection by one, but will not select a channel outside the range.

**Tip** ⇨ Press and hold [Next] while pressing [Last] to reselect the original channel range.

---

**Note:** When working with Ordered Groups, Next/Last will follow original selection order. Refer to "[Ordered Groups](#)" on page 131.

---

# LAMP CONTROL

## Start

Start will function for all arc luminaires with remote start capability.

### Start lamps using menu bar:

- Step 1. Select required channels.
- Step 2. Set luminaire(s) in recommended starting position according to manufacturer's specifications.
- Step 3. At **Special** menu, select **Start**.

### Start lamps using [Start] button:

- Step 1. Select required channels.
- Step 2. Set luminaire(s) in recommended starting position according to manufacturer's specifications.
- Step 3. At Channel Select panel, press [Start].

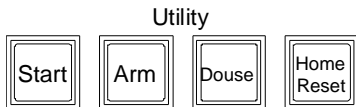

Special	Patch	Window	Info
Task Progress			⌘%T
Clear Status Errors			
Enable Remote Focus Control			
Park			
UnPark			
Select Parked			
Encoder Fan			▶
QuickFocus			%F
Highlight			
Select			▶
Manual Timing			
Status			▶
Reset ( Recalibrate )...			
Home...			
Erase Luminaire Data...			
Log Network Statistics			
Update Configuration			%U
Store Configuration			
Clear Stored Configuration			
Load Partition			
Load Display Filter			%D
Auto Display Filter			⇧%D
Clear Display Filter			
<b>Start</b>			
Douse			

## Douse

Douse will function for all arc luminaires with remote douse capability.

### Douse lamps using menu bar:

- Step 1. Select required channels.
- Step 2. At **Special** menu, select **Douse**.

### Douse lamps using [Douse] button:.

- Step 1. Select required channels.
- Step 2. At Channel Select panel, press and hold [Arm] while pressing [Douse].

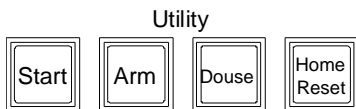

Special	Patch	Window	Info
Task Progress			⌘%T
Clear Status Errors			
Enable Remote Focus Control			
Park			
UnPark			
Select Parked			
Encoder Fan			▶
QuickFocus			%F
Highlight			
Select			▶
Manual Timing			
Status			▶
Reset ( Recalibrate )...			
Home...			
Erase Luminaire Data...			
Log Network Statistics			
Update Configuration			%U
Store Configuration			
Clear Stored Configuration			
Load Partition			
Load Display Filter			%D
Auto Display Filter			⇧%D
Clear Display Filter			
<b>Start</b>			
Douse			

## Home / Reset (Recalibration)

The [Home/Reset] button and corresponding menu items provide the following options:

- + **Home** - sets all parameter timing to zero and clears any intensity Mark or Zero states.
- + **Reset** - recalibrates luminaire.

[Home/Reset] is dual action button.

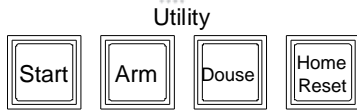

### Return parameters to defaults (home):

- Step 1. Select required channels.
- Step 2. Press and hold [Arm] while pressing [Home/Reset] once, *or* select **Home** from Special menu.

### Reset (recalibrate) luminaires:

- Step 1. Select required channels.
- Step 2. Press and hold [Arm] while pressing [Home/Reset] twice, *or* select **Reset** from Special menu.

## Erase Luminaire Data

The Erase Luminaire Data option will erase the luminaire's data from the show file.



**CAUTION:** There is NO undo for this action.

### Erase luminaire data from show file:

- Step 1. Select required channels.
- Step 2. At **Special** menu, select **Erase Luminaire Data**.

Special	Patch	Window	Info
Task Progress			⌘%T
Clear Status Errors			
Enable Remote Focus Control			
Park			
UnPark			
Select Parked			
Encoder Fan			▶
QuickFocus			%F
Highlight			
Select			▶
Manual Timing			
Status			▶
Reset ( Recalibrate )...			
Home...			
Erase Luminaire Data...			

Special	Patch	Window	Info
Task Progress			⌘%T
Clear Status Errors			
Enable Remote Focus Control			
Park			
UnPark			
Select Parked			
Encoder Fan			▶
QuickFocus			%F
Highlight			
Select			▶
Manual Timing			
Status			▶
Reset ( Recalibrate )...			
Home...			
Erase Luminaire Data...			
Log Network Statistics			
Update Configuration			%U
Store Configuration			
Clear Stored Configuration			
Load Partition			
Load Display Filter			%D
Auto Display Filter			⇧%D
Clear Display Filter			
Start			
Douse			



## ENCODER CONTROL

---

### Overview

The manual control encoders provide control of luminaire parameters. The encoders may be controlled using either the encoder knobs on the front panel or using the Encoders software window.

### Front Panel Encoders

The front panel provides a mix of "hard" and "soft" encoders. Pan, tilt, and intensity parameters are mapped to permanently assigned "hard encoders," while the remaining parameters are mapped to "soft encoders." The soft encoders control a variety of parameters depending on which function is currently selected and what type of luminaires are selected (mapping is based on luminaire capabilities, and therefore, will vary). Soft encoder control includes the following options:

- + **Color** - controls color functions such as CMY, RGBAW, wheels, flags, or color plates, plus some additional focus attributes.
- + **Beam** - controls edge, beam, zoom, frost, strobe, and prism.
- + **Image** - controls static gobo, rotating gobo, spin, and effects.
- + **3D** - allows scaled adjustments to time and delay (works with Timing Filter) and controls X, Y and Z coordinates for pan and tilt.
- + **Dynamics** - modifies rate, size, and offset for dynamics.
- + **Frame** - controls framing shutters.

By selecting a function, the soft encoders change to control the parameters of that function. These functions are luminaire specific when selecting single luminaire types. In addition to the encoder, minimum and maximum control buttons are provided to apply a default setting to selected luminaires. Like the soft encoders, the functionality of these buttons depends on the currently selected function. The min/max buttons are initially programmed with a default console setting, but can be reprogrammed with your own settings as required.

For complete instructions on using the front panel encoders, refer to "[Front Panel Encoders](#)" on page 61.

### Encoders Window

The Encoders window functions just as the front panel encoders, but also provides data for the currently selected cue or effect, and allows specification of a submaster for cue tracking.

For complete instructions on using the Encoders Window, refer to "[Encoders HUD Window](#)" on page 70.

### Fan Function

A special fan function is also available to provide five different types of encoder fanning styles.

For complete instructions on using the Fan Function refer to "[Fan](#)" on page 71.

## Front Panel Encoders

When a luminaire is selected for manual control, the encoders and buttons available on the front panel can be used to change its parameters.

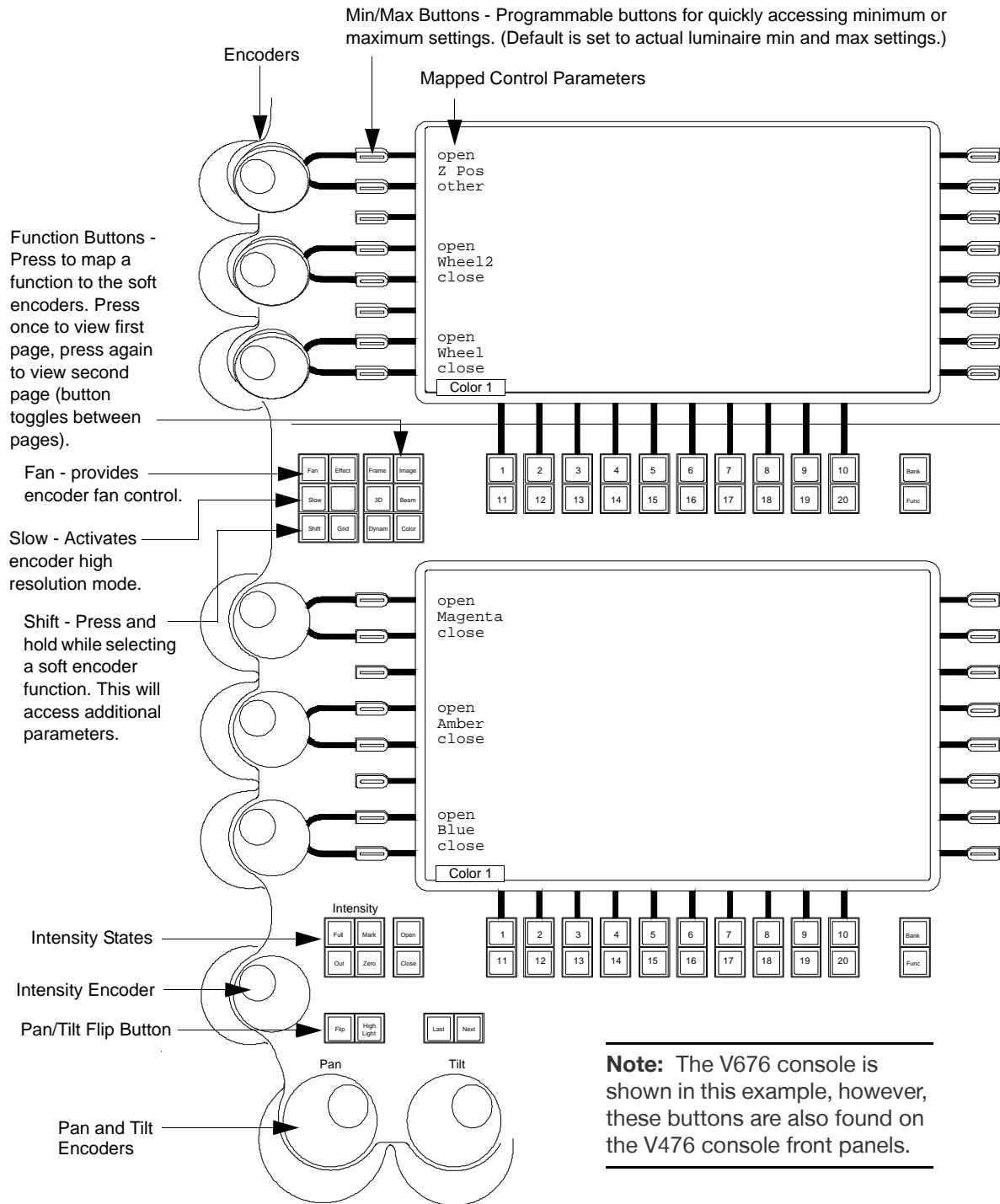

Figure 3-3: V676 and V476 Encoder Controls

When turning the encoder knobs on the V276 console front panel, the adjusted values will be displayed in the V276 HUD. (For more information about this window, refer to "V276 Display" on page 369.)

Function Encoders (4) -  
Four knobs which control luminaire parameters as selected by the Encoder Buttons.

Encoders Buttons -  
Selects a parameter type for control by Encoder Knobs.

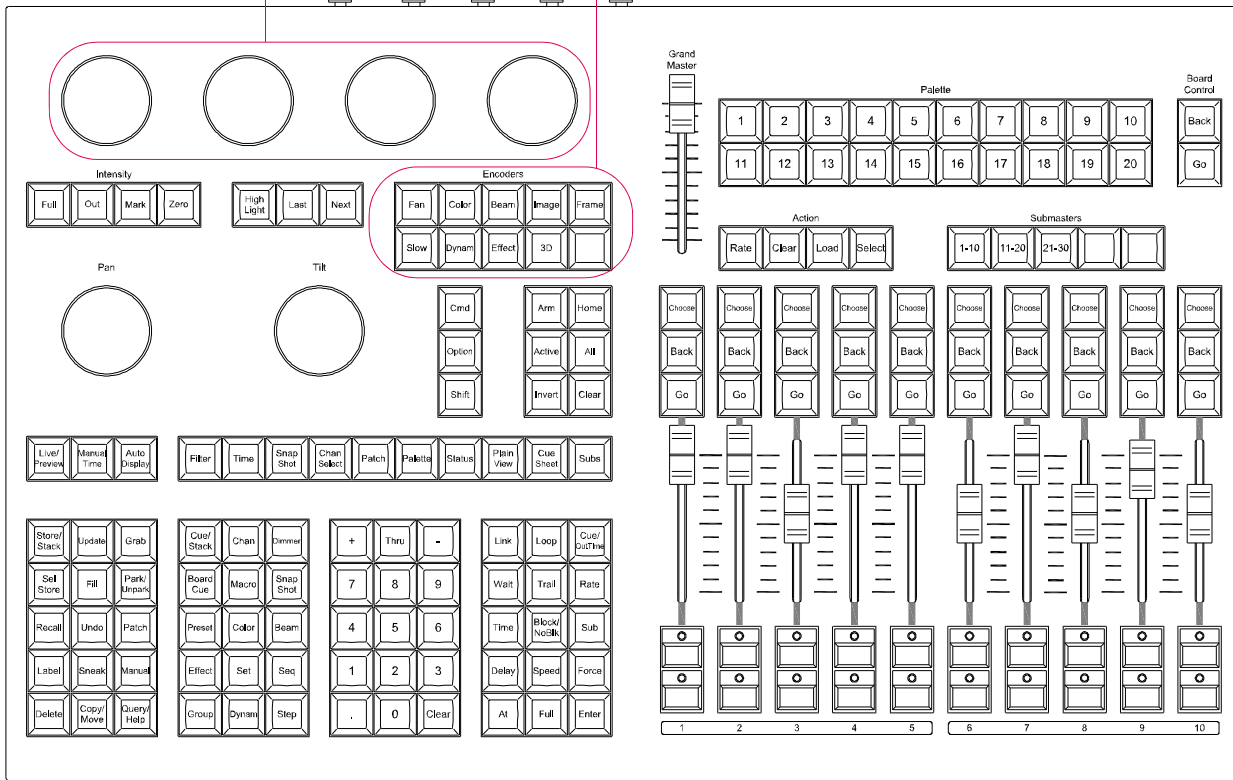

Figure 3-4: V276 Encoder Controls

## Value/Range Display

When an encoder function is selected (i.e., Color, Beam, Image, 3D, Dynamics, or Frame), the current value will be displayed in the touchscreen area and/or V276 HUD.

The value to the left of the encoder label shows the title of the range, while the value below the encoder label shows the parameter value or label (such as 'open' or 'full'). The range labels and defined values are set in the fixture profile.

The displayed value will come from the lowest selected channel.

The direct range and value selection can be changed by touching a parameter in the Encoder Sidebar. When touched, a list of options will pop-up in the display.

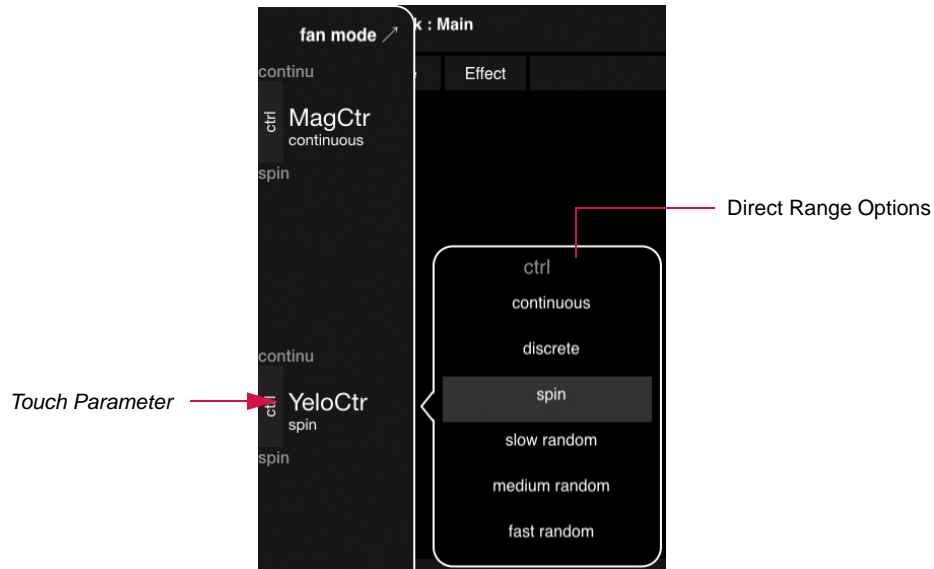

## Pan and Tilt

Pan and tilt are controlled by the two encoders marked Pan and Tilt respectively. These knobs can be used to change the position of a luminaire's beam.

Buttons above these encoders are also associated with pan and tilt functions:

- + [Flip] causes selected luminaires to pan and tilt until the head is pointing in the same direction as before. The head assembly pans 180 degrees and tilts as required so that the head points in the same direction. (Moving Mirror devices will not respond to this command.)
- + The [Next] and [Last] buttons step through all channels. (These buttons are also used with the QuickFocus feature. Refer to "[QuickFocus](#)" on page 199.)



Pan/Tilt control can be enabled for an attached track ball or other mouse device. When enabled, this will be indicated by a "Pan/Tilt Control" watermark on the monitor desktop.

### To enable track ball pan/tilt control:

- + At **Operation** menu, select **Pan/Tilt Control**.

### To release track ball pan/tilt control:

- + Click console trackpad or press ESC on the Mac keyboard.

Operation	Data	Special
Cue Sheet		
Board Cue Sheet		
Plan View		⌘B
3D Graphic		⌘G
Luminaire Status		⌘S
Tracking Changes		⌘S
Intensity		⌘I
Timecode		
Palettes		
Channel Select		
Century Palette		
Timing/Filter Display		
276 Display		
Command HUD		
Submaster HUD		
Encoder HUD		
Pan/Tilt Control		⌘.
X/Y Control		⌘'

**Note:** Highlight is an advanced function not associated with pan/tilt. Refer to "[Highlight](#)" on page 202 for more information about this feature.

## Intensity

Intensity output can be controlled by the Intensity encoder. This knob can be used to adjust the brightness of the luminaire's beam. Six buttons to the right of the Intensity encoder are also associated with the intensity function. (Intensity also affects how a cue is stored, however, this topic will be discussed in more detail in "[Intensity States](#)" on page 140.)

- + [Full] sets selected luminaires to full intensity (100%).
- + [Out] sets selected luminaires to an *out\** or *inactive* state (no parameter data, 0% level).
- + [Mark] sets selected luminaires to a *marked\** state (0% level).
- + [Zero] sets selected luminaires to *zero\** intensity ("hard zero", 0%).
- + Shutter [Open] is used with luminaire strobe or douser mechanisms.
- + Shutter [Close] is used with luminaire strobe or douser mechanisms.

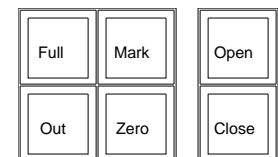

\* For a more in-depth explanation, refer to "[Intensity States](#)" on page 140.





## Color

When [Color] is selected, the soft encoder mapping is as follows:

### Page 1

- **Z Pos** (open/other)
- **Wheel 2** (open/close)
- **Wheel** (open/close) - also controls gel scrollers
- **Magenta** (open/close)
- **Yellow** (open/close)
- **Cyan** (open/close)

### Page 2

- **Z Index** (open/other)
- **Y Index** (open/other)
- **X Index** (open/other)
- **Color 8** (open/close)
- **Color 7** (open/close)
- **Color 6** (open/close)

## Beam

When [Beam] is selected, the soft encoder mapping is as follows:

### Page 1

- **Beam 2** (open/close)
- **Frost** (in/out)
- **Strobe** (stop/max)
- **Zoom** (large/small)
- **Edge** (hard/soft)
- **Beam** (open/close)

### Page 2

- **Prism Index** (open/other)  
w/ [Shift] button pressed - Rotate (stop/max)
- **Prism** (in/out)  
w/ [Shift] button pressed - Spin (stop/max)
- **OutFrame** (open/other)
- **InFrame** (open/other)
- **PlayMode** (open/other)
- **PlaySpeed** (open/other)



## Image (Gobo)

When [Image] is selected, the soft encoder mapping is as follows:

### Page 1

- Edge** (hard/soft)  
w/ [Shift] button pressed - Zoom (large/small)
- Effect Index** (open/other)  
w/ [Shift] button pressed - Effects Rotate (stop/max)
- Effect** (open/other)  
w/ [Shift] button pressed - Effects Spin (stop/max)
- Index** (open/other)  
w/ [Shift] button pressed - Rotate (stop/max)
- Rotating Gobo** (open/other)  
w/ [Shift] button pressed - Rotating Spin (stop/max)
- Gobo** (open/other)  
w/ [Shift] button pressed - Spin (stop/max)

### Page 2

- Edge 2** (hard/soft)
- Rotating Index3** (open/other)  
w/ [Shift] button pressed - Rotate (stop/max)
- Rotating Gobo3** (open/other)  
w/ [Shift] button pressed - Rotating Spin (stop/max)
- Rotating Index2** (open/other)  
w/ [Shift] button pressed - Rotate (stop/max)
- Rotating Gobo2** (open/other)  
w/ [Shift] button pressed - Rotating Spin (stop/max)
- Fixed Gobo2** (open/other)  
w/ [Shift] button pressed - Spin (stop/max)

## 3D

When [3D] is selected, the soft encoder mapping is as follows:

- Time** (zero/+1sec)  
w/ [Shift] button pressed - Time (zero/-1 sec)  
w/ [Fan] button pressed - Time (zero/fan+1 sec)
- Delay** (zero/+1sec)  
w/ [Shift] button pressed - Delay (zero/-1 sec)  
w/ [Fan] button pressed - Delay (zero/fan+1 sec)
- n/a
- Z** (min/max)
- Y** (min/max)
- X** (min/max)

The Time encoder works with the Timing Filter, making scaled adjustments to timing values. If Fan is turned on, the timing will be fanned out across the timing channels. (This is good for ripple effects.)

The Delay encoder also works with the Timing Filter, making scaled adjustments to delay values. If Fan is turned on, the delay will be fanned out across the selected channels. (This is good for ripple effects.)



## Dynamics

When [Dynam] is selected, the soft encoder mapping is as follows:

- **RATE** (5 sec / +1 sec)  
w/ [Shift] button pressed - RATE (5 sec / -1 sec)  
w/ [Fan] button pressed - RATE (5 sec / fan +1 sec)  
This encoder changes the rate of a dynamic on parameters selected in the Filter window. CCW speeds up the rate, while CW slows the rate down. The rate can also be fanned.
- **SIZE** (default / autoFit)  
This encoder changes the size of a dynamic on parameters selected in the Filter window. CCW decreases the size, while CW increases the size. The size can also be fanned.  
autoFit - automatically chooses the maximum size dynamic.
- **OFFSET** (min / +120)  
w/ [Shift] button pressed - OFFSET (min/-180)  
w/ [Fan] button pressed - OFFSET (min/fan +180)  
This encoder is used to determine where along the waveform, the dynamic should start. The Offset is measured in degrees where a complete waveform is 360 degrees (1 cycle). This function can be used to create "multi" looks when the offset is fanned across channels. (Note that the minimum is 0 degrees.)

Refer to the ["Dynamics" chapter on page 149](#) for more information about using the encoders with dynamics.

## Frame

When [Frame] is selected, the soft encoder mapping is as follows:

- **ROTATE**  
[mid] - sends framing mechanism back to its mid-point.  
[rot 90] - rotates framing mechanism 90 degrees from its current position.
- **ALL**  
[flip H] - flips framed image to a horizontal position.  
[flip V] - flips framed image to a vertical position.
- **SHUTTER 4**  
Button [max] selects Encoder 4 and controls both motors to bring the shutter in.  
Button [min] selects Encoder 4 and controls both motors to take the shutter out.
- **SHUTTER 3**  
Button [max] selects Encoder 3 and controls both motors to bring the shutter in.  
Button [min] selects Encoder 3 and controls both motors to take the shutter out.
- **SHUTTER 2**  
Button [max] selects Encoder 2 and controls both motors to bring the shutter in.  
Button [min] selects Encoder 2 and controls both motors to take the shutter out.
- **SHUTTER 1**  
Button [max] selects Encoder 1 and controls both motors to bring the shutter in.  
Button [min] selects Encoder 1 and controls both motors to take the shutter out.

## Effect

When [Effect] is selected, the soft encoder mapping is as follows:

- **Fade Out** (0.0)
- **Fade In** (0.0)
- **Decay** (0.0)
- **Sustain** (0.0)
- **Attack** (0.0)
- **Step** (0.0)

Refer to the **"Effects" chapter on page 169** for more information about using the encoders with effects.

## Storing New Default Minimum/Maximum Settings (V476/V676 Only)

The min/max buttons associated with each function can be programmed with your own default settings as required. These settings are referred to as hard/soft, in/out, etc. depending on the mechanism being controlled. The initial console default settings (which correspond to the luminaire's actual min/max values) can be re-stored with your own min/max settings.

The min/max settings are based on channel selection. This means that a different minimum and maximum setting can be defined for every channel or for groups of channels as required. For example, if Channel 1 is patched as a Bad Boy® luminaire you could select its channel and then store appropriate min/max settings. You could then deselect Channel 1 and select Channel 2 (which, for example is patched as a VL6C+® luminaire) and store different min/max settings. Depending on whether Channel 1 or Channel 2 is selected, the min/max settings would be different.

### Store new min/max settings:

- Step 1. Press encoder function button as required (Color, Beam, Image, etc.). The functions will be mapped to soft encoders.
- Step 2. Select luminaires to be included in min/max setting.
- Step 3. Using encoders, adjust parameter for new setting.
- Step 4. Press and hold [Store] while pressing [Encoder Min/Max Button]. Setting is now stored for those channels.

### Add new channels to a setting:

- Step 1. Select luminaires to be added to setting. (For example, select additional VL6C+ luminaires.)
- Step 2. Press and hold [Store] while pressing [Encoder Min/Max Button]. Setting is now stored for new luminaires as well as previously stored luminaires.

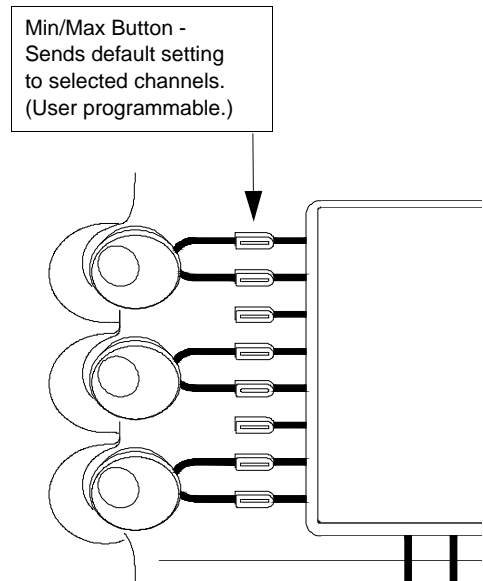

## Sliding Encoder Sidebar (V476 Only)

The sliding Encoder Sidebar is used with the six "soft" encoders available on the V476 front panel. The V676 has a designated area for displaying encoder controls, but since the V476 desk is smaller, these controls are displayed using the sliding sidebar. The sidebar appears in the same space as the central and palette displays when an encoder is turned or an encoder function button is pressed.

### Guidelines:

- + When an encoder is turned or an encoder function button is pressed, the sidebar will slide into view.
- + Press the encoder function button again to display the second page of options.
- + Double-click an encoder function button to lock the sidebar on.

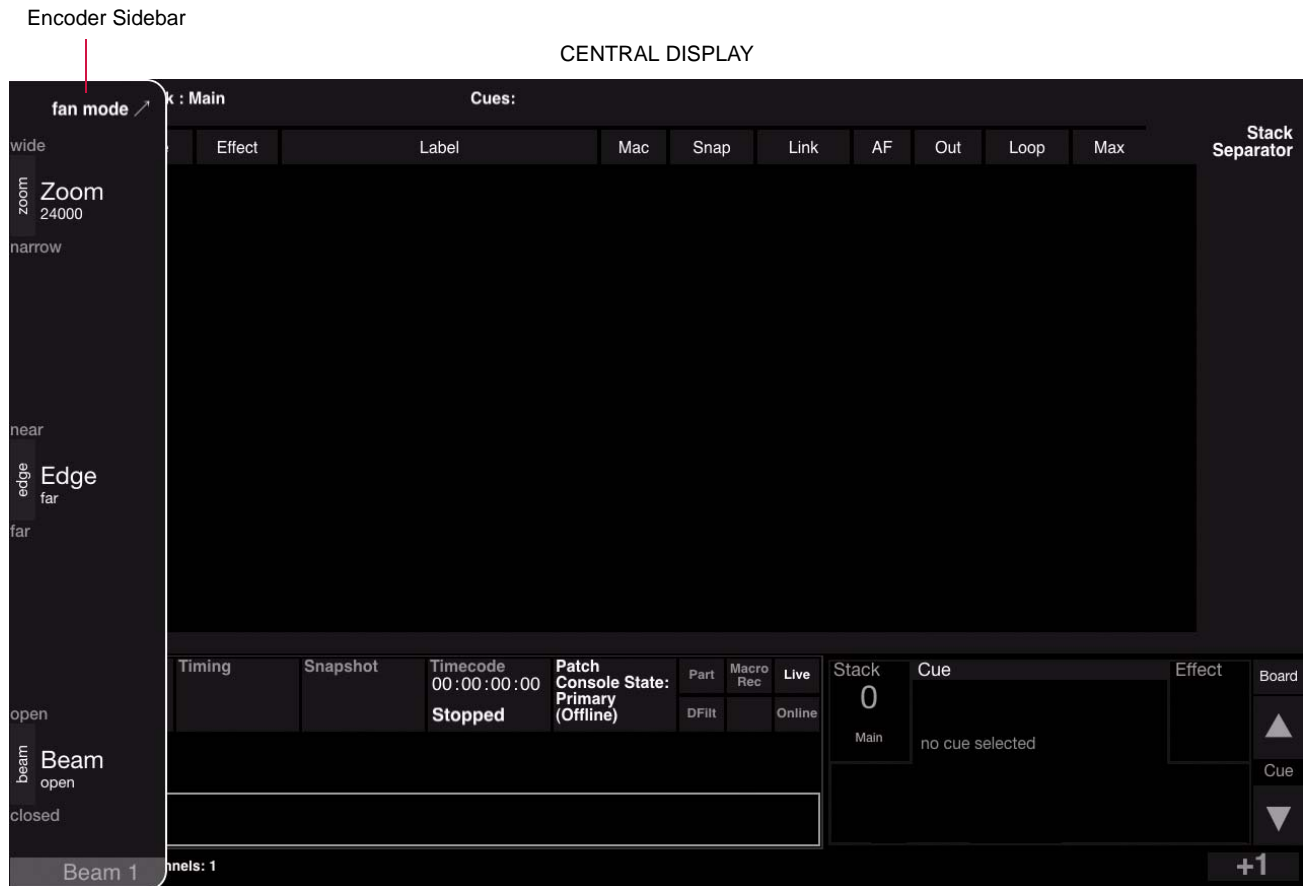

## Encoders HUD Window

The Encoders software window functions just as the front panel encoders to provide incremental control of luminaire parameters. Refer to the function explanations in the section **"Front Panel Encoders"** on page 61 for more in-depth information on each encoder function and the associated min/max settings.

### To operate the window controls:

- + At **Operation** menu, select **Encoder HUD** to open Encoders window.
- + To use a virtual encoder, press and hold the mouse down on a knob, then drag the mouse up or down to increase or decrease the parameter value.
- + Apply Shift, Control, Fan, and Slow features by clicking the buttons at the top of the window.
- + Switch between encoder types using the drop-down menu at the top of the window.
- + Click the pin icon at the top-right corner to keep the HUD on top of other windows. (When pinning is active, the pin icon will turn from gray to white.)

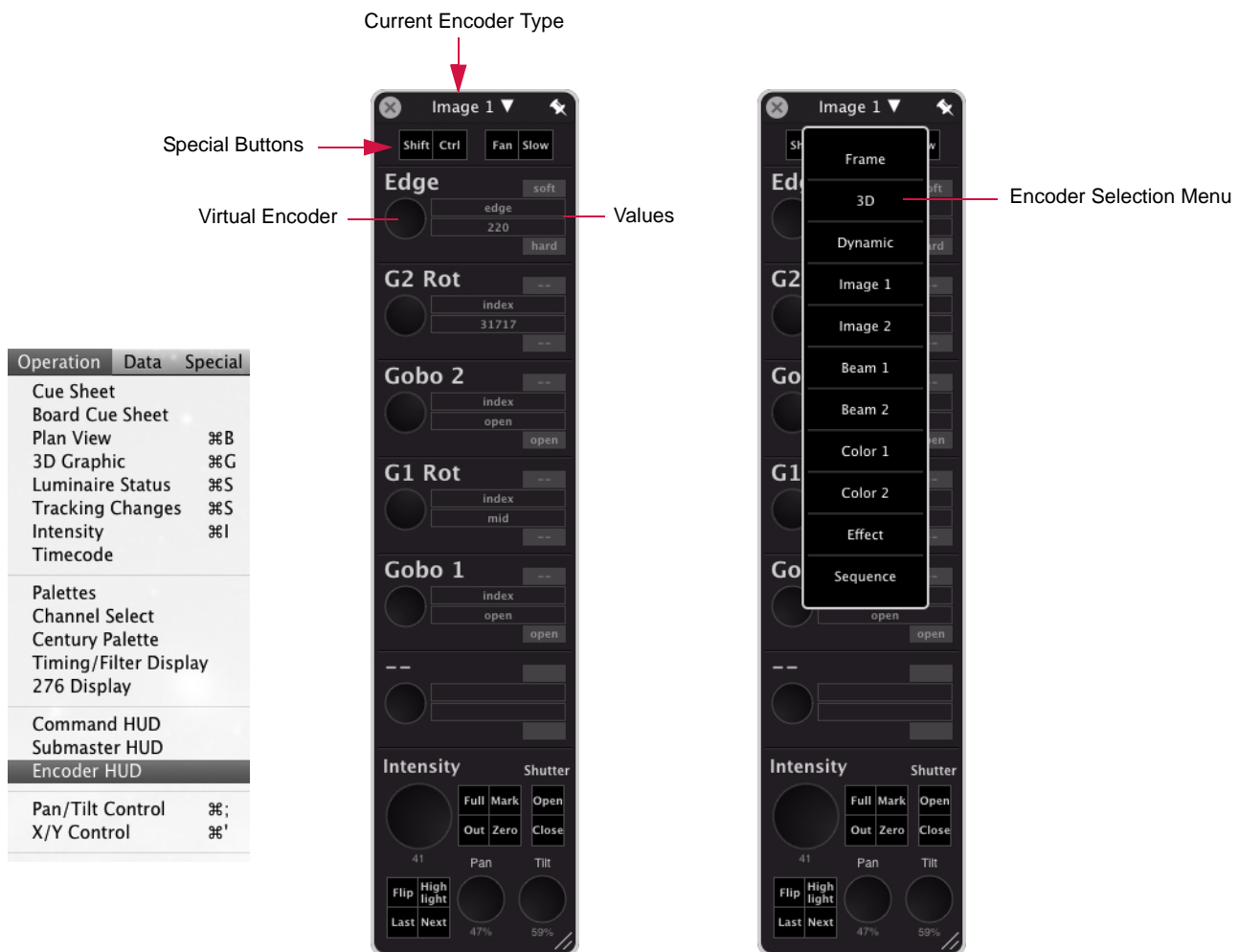

### Store new min/max settings:

- Step 1. Select luminaires to be included in min/max settings.
- Step 2. At Encoder window, select parameter group from drop-down menu.
- Step 3. Using encoders in window, choose a parameter for new setting.
- Step 4. Press and hold [Option], then click desired min/max button in window. Setting is now stored for those channels.

## Fan

The Fan function allows "fanning" of any encoder-controlled parameter across multiple channels. For example, it could be used to "fan" a dynamic across a group of luminaires in order to achieve a more random effect. It does this by giving each channel an "offset" starting point so that each luminaire starts the action at a different time (instead of simultaneously).

There are five fan mode types: Left fan, Right fan, Center fan, Ends fan, and Tilt fan. Each type uses a different anchor point for the base of the fan. Fan ordering is determined by selection order.

The fan mode can be changed from two locations: the **Special** menu or the front panel. These operations are as follows:

- 1) At **Special** menu, select **Encoder Fan**, then choose the mode.
- 2) At front panel, press <fan mode> button, then choose the mode.

### 1 Encoder Fan Menu

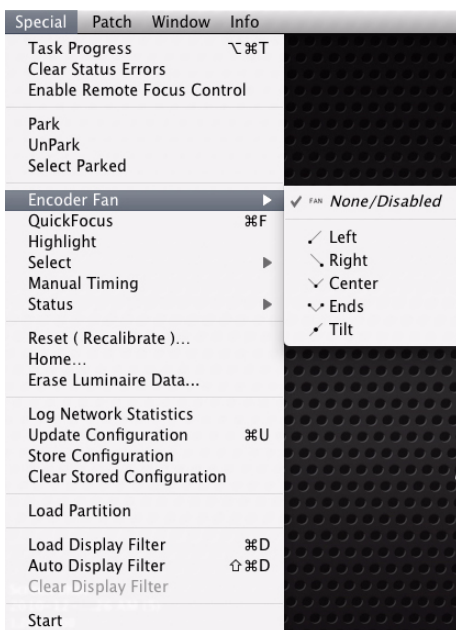

### 2 Front Panel

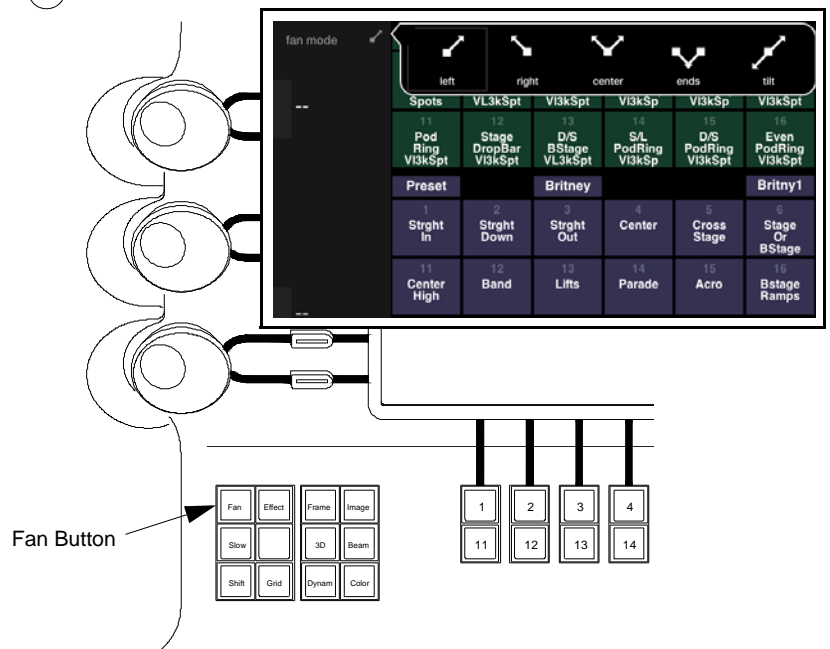

Once the fan mode is chosen:

- + At front panel, press and hold [Fan] button while turning an encoder. Double-clicking the [Fan] button will latch fan mode on (LED will flash). Double-click again to turn fan mode off.

**Note:** Timing and delay attributes can be "fanned" into channel selections using the soft encoders or command-line keypad. Refer to "**Fanned Timing and Delays**" on page 92 for more information.

## Encoder Fan Examples

The following are a few examples of fanning as shown in the 3D Graphic window:

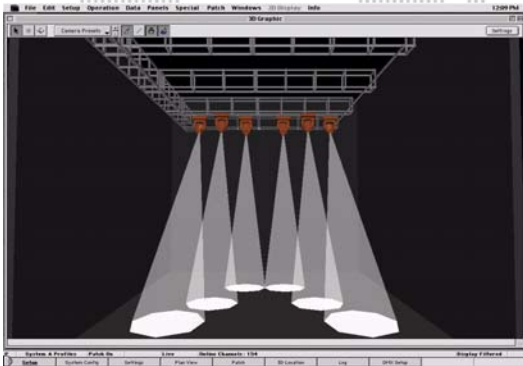

**Tilt Center Fan**

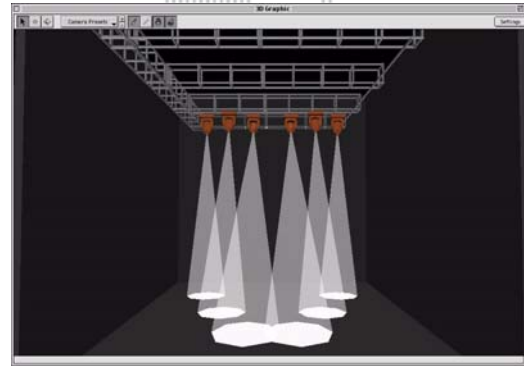

**Tilt Ends Fan**

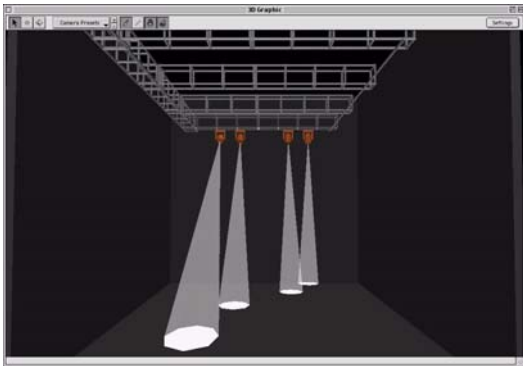

**Tilt Right Fan**

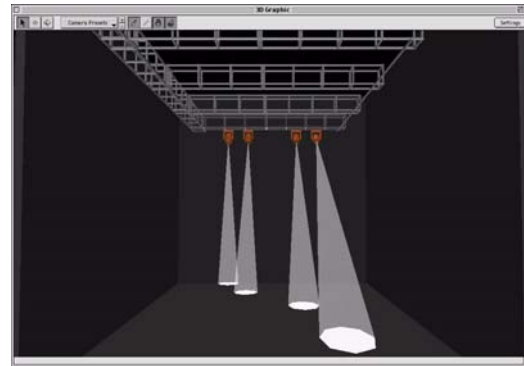

**Tilt Left Fan**

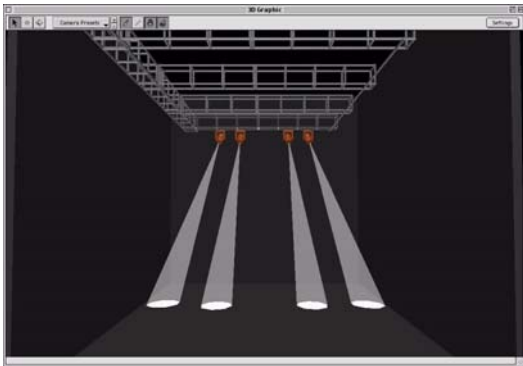

**Pan Out Fan**

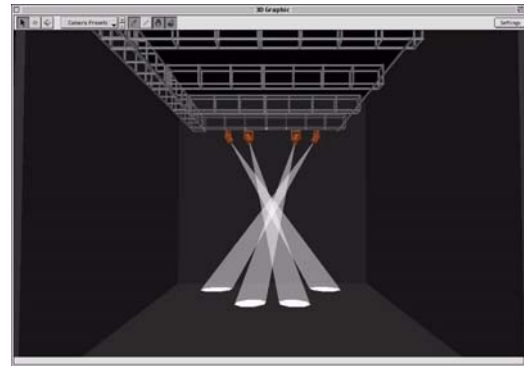

**Pan In Fan**



## High Resolution Mode

The encoder high resolution mode can be used for fine tuning luminaire parameters.

### To turn on high resolution mode:

- Step 1. At front panel, select desired encoder function (Preset, Color, Beam, etc.) by pressing its button.
- Step 2. Double-click [Slow] button to latch high resolution mode on (LED will flash when enabled).
- Step 3. Turn encoders to fine tune luminaire parameters.
- Step 4. Double-click [Slow] button again to turn high resolution mode off.

### To use high resolution "quick adjust" mode:

- Step 1. At front panel, select desired encoder function (Preset, Color, Beam, etc.) by pressing its button.
- Step 2. Press and hold down [Slow] button, while at the same time turning encoders. Adjustments to parameters will be high resolution as long as [Slow] button is held.

**Tip** ⇨ This mode is also useful when controlling media server attributes.

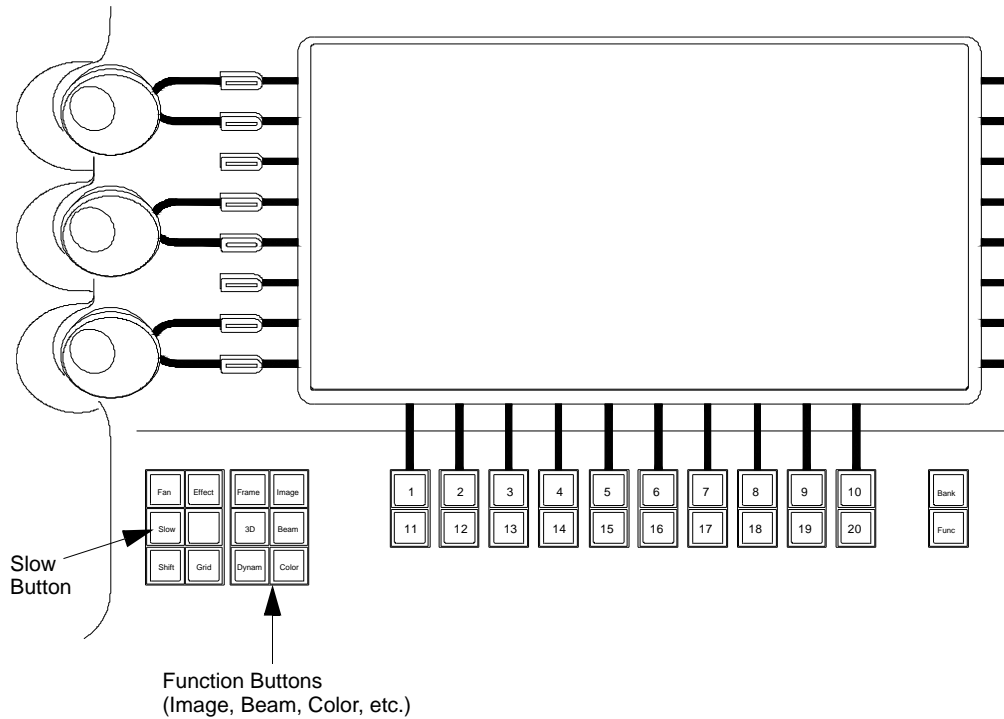

**Note:** The V676 console is shown in this example, however, these buttons are found on all Vx76 console front panels.

Figure 3-5: Slow Button

# KEYPAD CONTROL

## Overview

The control (or command-line) keypad also provides manual control of luminaires. Luminaire parameters can be set from the keypad just as they can from the manual control encoders, although in most cases the Sneak function is also required. This section will cover all manual controls that can be executed using the command-line keypad alone. Advanced manual control using the keypad will be discussed along with the Sneak function in "Timing, Filters and Sneak" chapter on page 85.

Annotations for the screenshot:

- Display Cue List →
- Display Plan View →
- Dashboard Controls →
- History Arrows →
- Command Line →
- Log Line →
- Cue Info →
- Increment Value →
- Cue Advance Arrows →

Convenience Keys - provides a front panel alternative to the Mac keyboard keys: Win (Command), Alt (Option) and Shift.

Mac Keys	Control (Command-Line) Keypad											
WIN =	Store	Update	Grab	Cue/Stack	Chan	Dimmer	+	Thru	-	Link	Loop	Cue/OutTime
ALT =	Sel Store	Block/UnBik	Park/Unpark	Board Cue	Macro	Snap Shot	7	8	9	Wait/Trail	Mark	Rate
SHIFT =	Recall	Undo	Patch	Preset	Color	Beam	4	5	6	Time	Delay/Speed	Sub
	Label	Sneak	Manual/Revert	Effect	Set	Seq	1	2	3	Track/CueOnly	Track Back	Force
	Delete	Copy/Move	Query/Help	Group	Dynam	Step	.	0	Clear	At	Full	Enter

Entries made with the keypad are referred to as "command-line entries" and will be displayed in the command-line display as they are entered.



```
> Store Color 8 *  
store color 8
```

```
> Recall Preset 15 *  
sel recall preset 15
```

*Command-line entry guidelines:*

- + When entering command lines, it is not necessary to specify channel information if the required channels are already selected. If new channels are selected for modification on the keypad, this is reflected at the Channel Select panel.
- + [Clear] functions as a backspace key when used during command-line construction. [Clear] is the only thing that clears a syntax error. (Any other keypad entry is ignored until the error condition is cleared.)
- + When working from the command-line keypad, parameters will assume their new values at full speed unless Manual Timing is currently enabled, in which case they will use their current timing values. Only when used with the Sneak function can the keypad selections be assigned discrete timing values.
- + Since manual control requires channel selection, this can also be done using the command-line keypad. Refer to Channel Select "**From Keypad**" on page 56.

**Tip** ⇨ Holding down [Clear] will clear an entire unterminated command line.



## Setting Parameters From Keypad

### Presets

The keypad can be used to assign presets to selected luminaires. The preset entered on the keypad corresponds to the preset saved in that particular Preset palette (refer to "Presets" on page 116).

*Examples:*

- + <Chan> [n] [Preset] [m] [Enter] - applies preset m to the selected channel n (where m is the discrete preset number).
- + <Chan> [n] [Thru] [q] [Preset] [m] [Enter] - applies preset m to the selected range of channels (where m is the discrete preset number).

### Colors

The keypad can be used to assign colors to selected luminaires. The color entered on the keypad corresponds to the color saved in that particular Color palette (refer to "Colors" on page 121).

*Examples:*

- + <Chan> [n] [Color] [m] [Enter] - applies color m to the selected channel n (where m is the discrete color number).
- + <Chan> [n] [Thru] [q] [Color] [m] [Enter] - applies color m to the selected range of channels (where m is the discrete color number).

### Beams

The keypad can be used to assign beams to selected luminaires. The beam entered on the keypad corresponds to the beam state saved in that particular Beam palette (refer to "Beams" on page 125).

*Examples:*

- + <Chan> [n] [Beam] [m] [Enter] - applies beam state m to the selected channel n (where m is the discrete beam number).
- + <Chan> [n] [Thru] [q] [Beam] [m] [Enter] - applies beam state m to the selected range of channels (where m is the discrete beam number).

---

**Note:** If a profile does not provide default color and beam data, then there will be no change for selected channels until custom color and beam palettes are stored.

---



## Intensity

The keypad can be used to adjust the brightness of the luminaire's beam. Intensity responds to a percentage value of 0-100.

The [At] button is used to enter intensity values:

- + <Chan> [n] [At] [m] [Enter] - changes the intensity level of the selected channel to m.
- + <Chan> [n] [Thru] [q] [At] [m] [Enter] - changes the intensity level for the selected range of channels to m.

The [Full] button is used to quickly set intensity to 100%.

- + <Chan> [n] [Full] [Enter] - changes the intensity level of the selected channel to 100%.

The [+] and [-] buttons can be used in combination with the [At] button to increment or decrement a current intensity value by a specific amount. For example, if the current intensity value is 50%:

- + <Chan> [n] [At] [+] [0] [5] [Enter] - increases the intensity level of the selected channel to 55%.
- + <Chan> [n] [At] [-] [0] [5] [Enter] - decreases the intensity level of the selected channel to 45%.

**Tip** ⇨ To quickly enter an intensity below 91%, but divisible by 10, use only the first digit of the desired level (for example, [At] [5] = 50%).

To Mark a channel on the command line, enter the following sequence:

- + [Chan] [n] [At] [At] [Enter]

# LUMINAIRE STATUS

## Luminaire Status Window

### Overview

The Luminaire Status window can be used to view current luminaire data as a numeric value or preset reference. (The window is merely a way to display and review data and does not provide editing functions.)

- + At Operation menu, select **Luminaire Status**. (Data will be displayed for all luminaires.)

Operation	Data	Special
Cue Sheet		
Board Cue Sheet		
Plan View		⌘B
3D Graphic		⌘G
Luminaire Status		⌘S
Tracking Changes		⌘5
Intensity		⌘I

**Note:** Multiple Luminaire Status windows can be open at the same time with different settings for each.

The screenshot shows the Luminaire Status window interface with several callouts pointing to specific features:

- Window Display Settings:** Points to the window title bar and the 'Cell Contents' menu (V P L T D C X).
- Manual Filter:** Points to the 'Enable Manual Filter' button.
- Toggle Value or Percent Data:** Points to the '#/%' toggle button.
- Column Settings:** Points to the 'Columns...', 'Reset Order', 'Size to Fit', and 'Set Columns' buttons.
- Channel Controls:** Points to the 'Set Channels' and 'Freeze Channels' buttons.
- Enable/Disable Color Coding:** Points to the 'Disable Colors' button.
- Font Settings:** Points to the 'Smaller Font' and 'Bigger Font' buttons.

The main data table below shows the following columns: Channel, Device, Inten, Focus, Pan, Tilt, 3D, Color, Blue, Amber, Magenta, Wheel, Beam, Edge, Zoom, Strobe, Gobo, R Gobo, Index, Misc1.

Channel	Device	Inten	Focus	Pan	Tilt	3D	Color	Blue	Amber	Magenta	Wheel	Beam	Edge	Zoom	Strobe	Gobo	R Gobo	Index	Misc1	
35	VL2500S			pan	tit				cyan open	yellow open	magenta open	choice open	beam open	edge soft	zoom small	shutter open	choice open	index open	index open	control idle
				32767	32767	45'1 -12'4 45'8			0	0	0	0	255	0	0	0	0	0	32767	0
				pan	tit				0	0	0	0	255	0	0	0	0	0	32767	0
36	VL2500S	100		46345	8757	30'0 -37'0 -2'7			165	0	0	0	255	0	0	0	0	0	32767	0
		100		46345	8757	30'0 -37'0 -2'7			165	Co 2 CYAN	Co 2 CYAN	Co 2 CYAN	255	0	0	0	0	0	32767	0
				pan	tit				cyan	yellow open	magenta open	choice open	beam open	edge soft	zoom small	shutter open	choice open	index open	index open	control idle
37	VL2500S	100		41509	55727	29'6 -35'11 0'9			165	0	0	0	255	0	0	0	0	0	32767	0
		100		41509	55727	29'6 -35'11 0'9			165	Co 2 CYAN	Co 2 CYAN	Co 2 CYAN	255	0	0	0	0	0	32767	0
				pan	tit				cyan	yellow open	magenta open	choice open	beam open	edge soft	zoom small	shutter open	choice open	index open	index open	control idle
38	VL2500S			42749	19817	57'3 -14'1 -8'1			168	65	0	0	255	0	0	0	0	0	32767	0
				42749	19817	57'3 -14'1 -8'1			168	65	Co 2 CYAN	Co 2 CYAN	255	0	0	0	0	0	32767	0
				pan	tit				cyan	yellow	magenta open	choice open	beam open	edge soft	zoom small	shutter open	choice open	index open	index open	control idle
39	VL2500S			42749	19817	58'9 -14'4 -13'2			168	65	0	0	255	0	0	0	0	0	32767	0
				42749	19817	58'9 -14'4 -13'2			168	65	Co 2 CYAN	Co 2 CYAN	255	0	0	0	0	0	32767	0
				pan	tit				cyan	yellow	magenta open	choice open	beam open	edge soft	zoom small	shutter open	choice open	index open	index open	control idle
40	VL2500S			42749	19817	60'6 -14'7 -18'6			255	0	0	0	255	0	0	0	0	0	32767	0
				42749	19817	60'6 -14'7 -18'6			255	Co 2 CYAN	Co 2 CYAN	Co 2 CYAN	255	0	0	0	0	0	32767	0
				pan	tit				cyan	yellow open	magenta open	choice open	beam open	edge soft	zoom small	shutter open	choice open	index open	index open	control idle
41	VL2500S			42749	19817	62'6 -14'10 -24'0			255	0	0	0	255	0	0	0	0	0	32767	0
				42749	19817	62'6 -14'10 -24'0			255	Co 2 CYAN	Co 2 CYAN	Co 2 CYAN	255	0	0	0	0	0	32767	0
				pan	tit				cyan	yellow open	magenta open	choice open	beam open	edge soft	zoom small	shutter open	choice open	index open	index open	control idle
42	VL2500S			42749	19817	63'2 -10'1 -8'0			255	0	0	0	255	0	0	0	0	0	32767	0
				42749	19817	63'2 -10'1 -8'0			255	Co 2 CYAN	Co 2 CYAN	Co 2 CYAN	255	0	0	0	0	0	32767	0
				pan	tit				cyan	yellow open	magenta open	choice open	beam open	edge soft	zoom small	shutter open	choice open	index open	index open	control idle
43	VL2500S			42749	19817	64'9 -10'4 -13'3			255	0	0	0	255	0	0	0	0	0	32767	0
				42749	19817	64'9 -10'4 -13'3			255	Co 2 CYAN			0	0	0	0	0	0	32767	0

The parameter columns which are displayed can be changed via the Parameter Columns window. Refer to "Parameter Columns Window" on page 82.



## Display Settings

Use the following buttons to display different types of data:

- + **Value (V)** - displays the numeric value currently being received by the luminaire for each parameter.
- + **Parameter (P)** - displays the Preset, Color or Beam which the parameter is currently referencing (default setting).
- + **Shifted Parameter (S)** - displays any shifted parameters which have been set at encoders.
- + **Timing (T)** - displays any associated timing information.
- + **Dynamic (D)** - displays any associated dynamic state information and continuous action such as wheel spins.
- + **Cue Source (C)** - displays the source cue for each parameter.
- + **Execution Time (X)** - displays remaining execution and delay times.
- + **Column Window (Columns...)** - opens parameter column window that determines which parameters are displayed.
- + **Set Channels (Chan)** - sets channels from the current channel selection, as limited by the display filter (toggle action). (Refer to "Display Filters" on page 311.)
- + **Freeze Channels (F)** - channels are set to the currently visible channels, and are not affected by subsequent changes to the global display filter (toggle action).

## Keyboard Shortcuts and Tips

- + WIN + R = Reset Order
- + WIN + SHIFT + R = Size To Fit
- + Holding down ALT on the Mac keyboard or [Option] on the front panel and clicking a column will lock the column in place. (Note that locked columns will be moved to the left of the unlocked columns.)
- + Click on a column's header and drag to reposition the column.
- + Hold the cursor over the toolbar icons to view "What's This?" text.

## Color Coding

The Luminaire Status values are color coded in order to provide useful information regarding how the values are changing from cue to cue, and if a value comes from manual control or an effect. Color indications are as follows:

<b>Magenta</b> = unchanged values.	<b>Orange</b> = values changed by manual control.
<b>Blue</b> = increasing intensity values.	<b>Gray</b> = values changed by an effect.
<b>Green</b> = decreasing intensity values.	<b>Brown</b> = values changed by another console.

## Changing Data Values

Data values can be increased or decreased for the selected luminaires by clicking on a column header and then holding down the CTRL button on the Mac keyboard while pressing the keyboard's up/down arrows.

When working with either the Pan or Tilt columns, pressing CTRL + SHIFT + UP or DOWN arrow will increment or decrement the alternate parameter (Tilt when Pan is selected and vice versa).

## Manual Change Filter

The Luminaire Status window provides a method for displaying only channels and parameters that have been modified manually. This provides a quick way to see which channels have been modified from recalled cues.

### To use the Manual Filter:

- + Click **Enable Manual Filter** icon to display manually modified channels.
- + To disable Manual Filter, click **Disable Manual Filter** icon.

The screenshot shows the Luminaire Status window with a toolbar at the top. The 'Disable Manual Filter' icon, which depicts a document with a pencil, is circled in red. Below the toolbar is a table with the following columns: Channel, Device, Focus, Pan, Y Index, Tilt, Color, Blue, Amber, Magenta, Wheel, Edge, Gobo, and R Gobo. The table contains data for channels 1 through 42.

Channel	Device	Focus	Pan	Y Index	Tilt	Color	Blue	Amber	Magenta	Wheel	Edge	Gobo	R Gobo
1	VL2000W		---	57.7"		-62.9°	Co 2 ...	0.0%	0.0%	0.0%	0.0%	62.7%	
2	VL2000W		---	57.7"		-62.9°	Co 2 ...	0.0%	0.0%	0.0%	0.0%	62.7%	
3	VL2000W		---	57.7"		-62.9°	Co 2 ...	0.0%	0.0%	0.0%	0.0%	62.7%	
4	VL2000W		---	57.7"		-62.9°	Co 2 ...	0.0%	0.0%	0.0%	0.0%	62.7%	
5	VL2000W		---	57.7"		-62.9°	Co 2 ...	0.0%	0.0%	0.0%	0.0%	62.7%	
38	VL2500S											0.0%	0.0%
39	VL2500S											0.0%	0.0%
40	VL2500S											0.0%	0.0%
41	VL2500S											0.0%	0.0%
42	VL2500S											0.0%	0.0%

## Customizing Luminaire Status Window

The Luminaire Status Window can be customized using:

- + Column resizing, including Size Columns To Fit in View Menu. (Click on the column divider to resize.)
- + Column repositioning. (Click on column header and drag to new position.)
- + Font resizing.
- + Value/Percent display option.
- + Color coding.
- + Set columns with current function filter.
- + Set channels from the current channel selection. (The displayed channels will still also be limited by the display filter.)
- + Freeze channels. (When frozen, the table's channels are set to the currently visible channels, and are not affected by subsequent changes to the global display filter.)

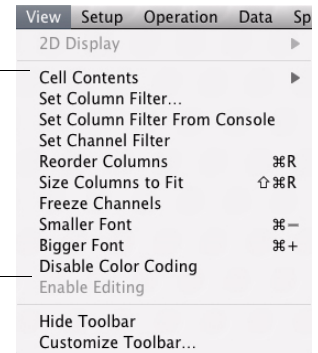

### To customize window:

- + At View menu, select parameter to update window configuration.



## Customizing Luminaire Status Toolbar

The Luminaire Status Window toolbar can be customized using the Customize Toolbar window.

### To customize toolbar:

- Step 1. At **View** menu, select **Customize Toolbar**.
- Step 2. Drag icons or default set into toolbar.

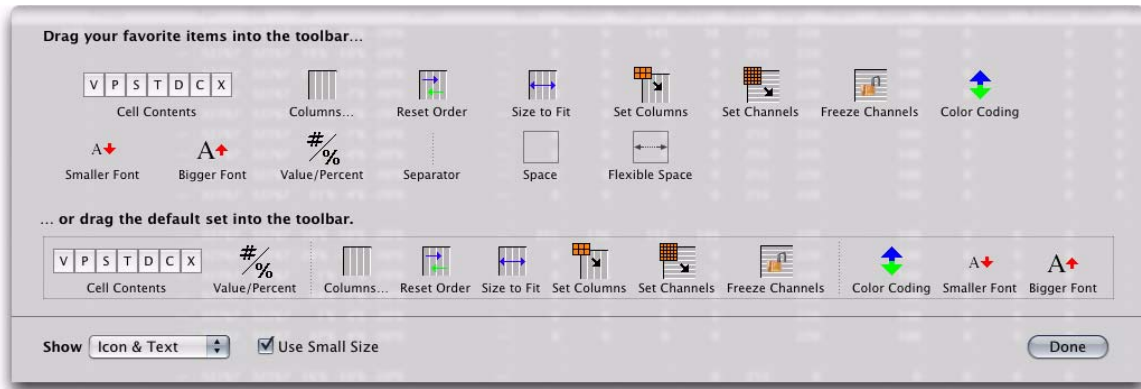
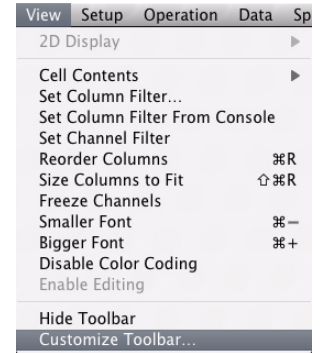

## Selecting Channels from Luminaire Status Window

Channels can be selected from the Luminaire Status window by clicking in the channel field. (This must first be configured in Settings window as shown below.)

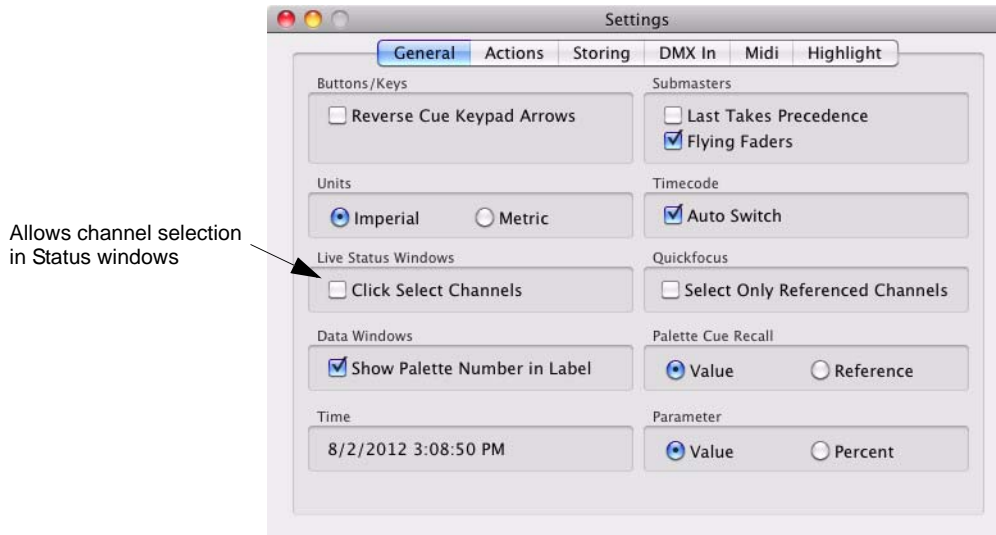

## Parameter Columns Window

The Parameter Columns window is used to define which types of information will be displayed in the data window (columns). Using the cursor, select or deselect the boxes as required.

For Focus and Color, two display options are available. Focus can be displayed as a single column and/or two columns, pan and tilt. Color can likewise be displayed as a single column and/or up to four individual color columns, which would provide data for each filter/wheel/plate mechanism in the luminaire. When the single Focus/Color box is checked, the column will display the Preset/Color source, as long as the data is being taken from a single Preset/Color. If not from a single Preset/Color, then the column would display "---." If Pan/Tilt, etc. are checked then those columns also display the source, or if set by encoders, the numerical values. To see both source and # values, select [P] and [M] (at Luminaire Status window).

Parameters with a checked box will be displayed in window

Right-click with mouse or trackpad to bring up shortcut options.

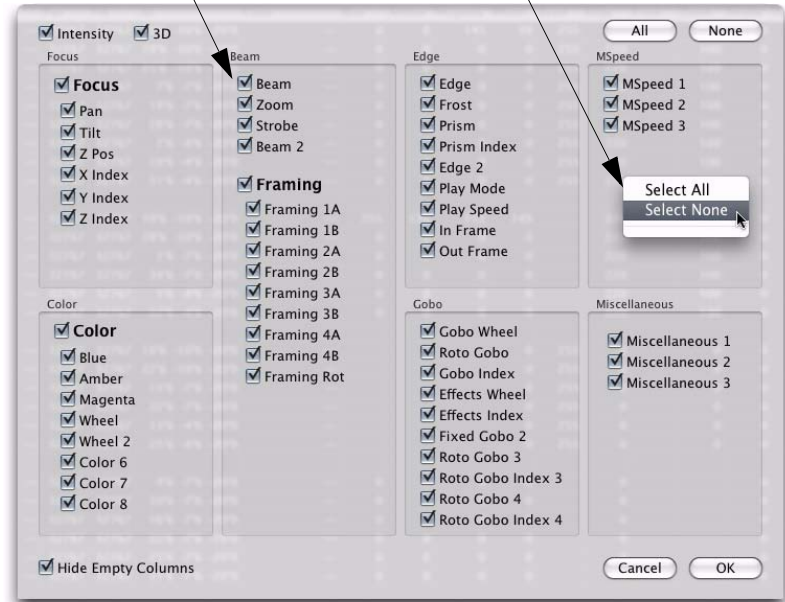

## Intensity Window

The Intensity window can be used to view intensity values for all patched channels. Selections made at the Channel Select window or panel and/or command-line keypad are highlighted in the window and subsequent changes to intensity values are reflected in the display.

- + At **Operation** menu, select **Intensity**.
- + Using manual controls, change intensity values as required. Changes will be reflected in display.

Operation	Data	Special
Cue Sheet		
Board Cue Sheet		
Plan View		⌘B
3D Graphic		⌘G
Luminaire Status		⌘S
Tracking Changes		⌘S
Intensity		⌘I
Timecode		

**Note:** Multiple Intensity windows can be open at the same time with different settings for each.

Intensity Values

Unpatched	Follow Auto	Set Local	Parameter	Value	Source	Zoom													
501	502	503	505	506	507	508	509	510	511	512	513	514	515	516	517	518	519	520	521
100	100	100	100	100	100	100	100	100	100	100	100	100	100	100	100	100	100	100	100
522	523	524	525	526	527	528	529	530	531	532	533	534	535	536	537	538	539	540	541
100	100	100	100	100	100	100	100	100	100	100	100	100	100	100	100	100	100	100	100
542	601	602	603	604	605	606	607	608	609	610	611	612	613	614	615	616	617	618	619
100	100	100	100	100	100	100	100	100	100	100	100	100	100	100	100	100	100	100	100
620	621	622	623	624	625	626	627	628	629	630	631	632	633	634	635	636	637	638	1001
100	100	100	100	100	100	100	100	100	100	100	100	100	100	100	100	100	100	100	100
1002	1003	1004	1005	1006	1007	1008	1009	1010	1011	1012	1013	1014	1015	1016	1017	1018	1019	1020	1021
1022	1023	1024	1025	1026	1027	1028	1029	1030	1049	1050	1051	1052	1053	1055	1056	1057	1058	1059	1061
1062	1063	1064	1065	1066	1067	1068	1069	1070	1072	1073	1074	1075	1076	1077	1078	1079	1080	1081	1082
1097	1098	1099	1100	1101	1103	1104	1105	1106	1107	1109	1110	1111	1112	1113	1115	1116	1117	1118	1119

## Color Coding

Color coding of the intensity values provides useful information regarding how the channels are changing from cue to cue, and if an intensity level comes from manual control or an effect. The coloring of channel numbers and intensity values provide the following indications:

<b>Magenta</b> = unchanged values.	<b>Yellow Background</b> = values changed by manual control.
<b>Blue</b> = increasing intensity values.	<b>White</b> = values changed by an effect.
<b>Green</b> = decreasing intensity values.	<b>Brown</b> = values changed by another console.
<b>Pink</b> = channels with the same cue intensity (tracking).	<b>Red Box</b> = parked channels.
<b>Red Underline</b> = channels which are not outputting the given intensity value. This will occur when a channel's intensity value is being reduced by the grandmaster or an inhibitive submaster.	

For example, if channels are brought up manually using an encoder, the channel numbers turn to *red* to indicate that they are manually controlled. Next, if a cue is played back which overrides the intensity of these channels (HTP), the values would be displayed in blue - refer to "**HTP (Highest Takes Precedence)**" on page 301. (If the cue does not override the intensity, they would remain in the manual control state color.) If another cue is played back in which the channels in blue fade down or out, they would change to green during the fade.

## Configuring How Information is Displayed

In the window's default state, all patched channels are listed horizontally with a vertical line inserted between non-consecutive channel numbers.

User defined columns: All channels shown with unpatched channels grayed out, width of window can be changed to modify the number of channels displayed in each row, scroll bar allows access to all channels.

## Displaying an Additional Parameter

The Intensity window can display an additional parameter below the intensity level. This can be used for scrollers to show the color value, or for any other single parameter. Once selected, the window will display the parameter type at the top. The default setting is "none."

- + To display an extra parameter, choose one from the Parameter pop-up menu.

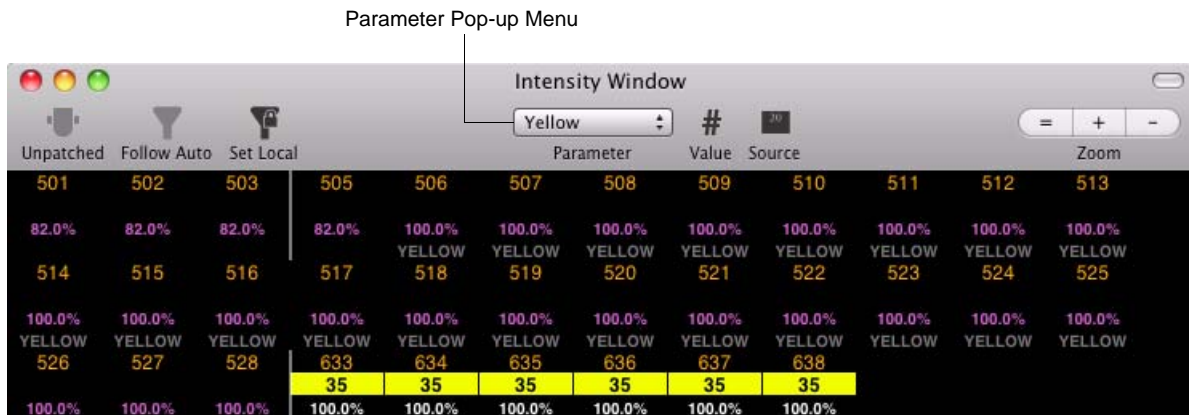

## Configuring Other Window Options

The icons at the top of the Intensity window can be used to configure what kind of information is displayed in the window. When enabled, an icon will be dark; when disabled, it will be grayed out.

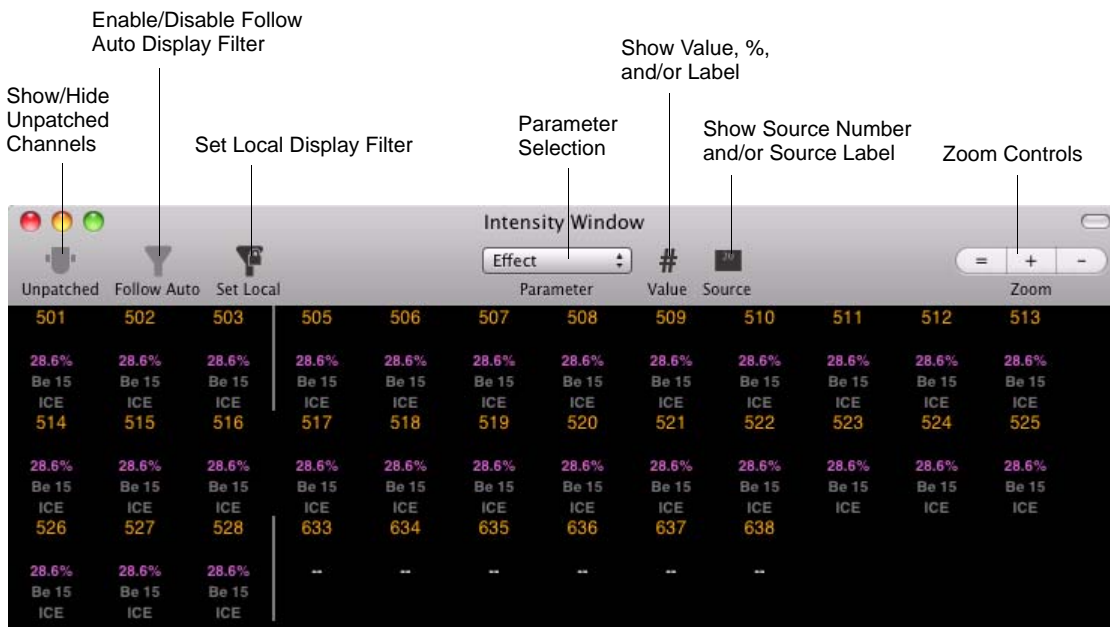



## 4.

# TIMING, FILTERS AND SNEAK

This chapter provides instructions for using the timing filter, function filter and sneak features.

- + [OVERVIEW](#)
- + [TIMING FILTER](#)
- + [FUNCTION FILTER](#)
- + [SNEAK](#)
- + [TEMPLATES](#)

## OVERVIEW

### Timing Filter, Function Filter and Sneak

The Timing Filter, Function Filter and Sneak features can be used alone or in conjunction with the command-line keypad to apply parameter timing values and function filters during store and playback operations, and to manually control luminaires "on the fly".

- + **Timing Filter** - used to apply timing, delay, and speed values to any and all combinations of parameters.
- + **Function Filter** - used to withhold (or mask) information from a preset or a cue, and to control what is recalled in a submaster or palette.
- + **Sneak** - used to graphically display command-line entries and to create manual control moves "on-the-fly."

#### Example of Timing Filter Touchscreen

The screenshot shows the Timing Filter Touchscreen interface. The main area is a grid of buttons for various parameters. The bottom control bar includes a Filter section with a keypad, a Timing section, a Snapshot section, a Timecode section, a Patch Console State section, and a Stack section. The Filter section is circled in red.

Cue List		⊗ ⊕				Wheel 2	Beam2	Edge2	E Index	Speed1	Stack Separator	
Plan View		Timing Filter				Wheel	Framing	P Index	Effect	Speed2		
		Manual Time		Z Pos		Magenta	Strobe	Prism	Index	Speed3	Time Filter Enter	
		Page 1		Up	Tilt	Amber	Zoom	Frost	R Gobo			
		All		Down	Pan	Blue	Beam	Edge	Gobo		Filter All	
		Clear		INTEN	FOCUS	COLOR	BEAM	EDGE	GOBO	ENTER		
Utilities		Time 5 Secs	Time 10 Secs	Delay 5 Secs	4	5	6	7	8	9	10	Filter Clear
		11	12	13	14	15	16	17	18	19	20	

Bottom Control Bar:

- Filter: I F E, C B G
- Timing: [ ]
- Snapshot: [ ]
- Timecode: 00:00:00:00 Stopped
- Patch Console State: Primary Ready
- Part: DFILT
- Macro Rec: [ ]
- Live: Online
- Stack: 0
- Cue: no cue selected
- Effect: [ ]
- Board: [ ]
- Hist: > ready (channel)
- +1

**Note:** The Timing Filter is automatically displayed when either [Time] or [Speed] buttons are pressed in the command line. It returns to the previous state when [Enter] is pressed.

## General Operations

Operation of the Timing Filter and Function Filter can be done from the central touchscreen available on the front panel (V476/V676 only) or the Timing/Filter Display window (available from the **Operation** menu). The operations are basically identical whether you are using the touchscreen or software window.

### To select the mode:

To open the Timing Filter or Function Filter, press the appropriate button at the bottom of the touchscreen. Only one mode is visible at a time, although in the case of the Function Filter, it does not have to be visible for selected filters to affect console operation.

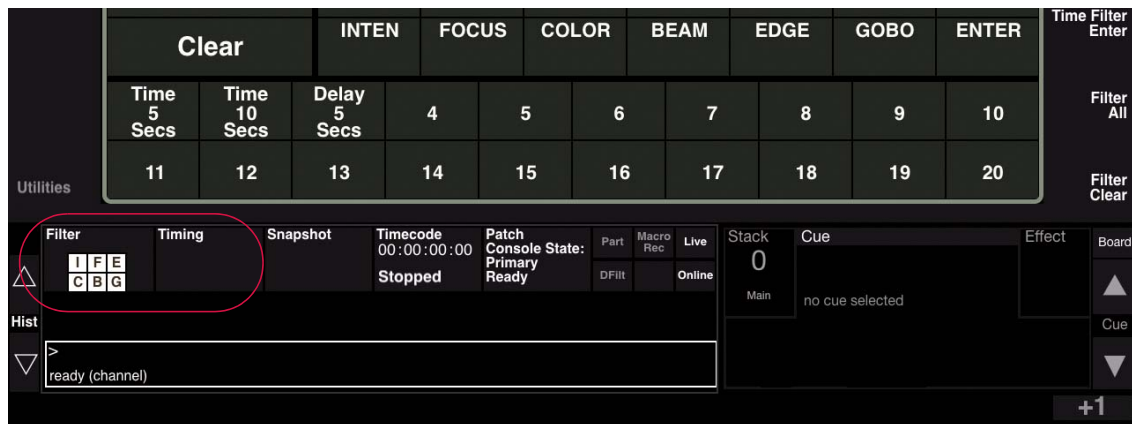

**Note:** If a store command is initiated while the touchscreen is in the Timing Filter, then the screen will automatically switch to the Function Filter until the store operation is complete.

### To set parameters:

Select parameters by touching the appropriate location on the screen, and when necessary, enter values using the command-line keypad.

Depending on the current function, <Time Filter Enter> or <Function Filter To Cue> must be pressed before the settings will be applied to store or playback operations.

### Templates:

The template section, found at the bottom of both the Timing Filter and Function Filter screens, provides 20 programmable templates that can be used to store frequently used settings.

# TIMING FILTER

## Overview

The Timing Filter is used to control the duration, delay, and speed of parameter transitions. For example, timing can be used to define how fast a luminaire will pan from one position to another and how long it will take for its intensity to fade from 0 to 100 percent.

Timing (total transition time), delay, and speed values can be applied to any and all combinations of parameters within a cue. Timing *or* speed can be entered along with a delay, but not both. These values can be different for each parameter of each luminaire as required.

*Example:*

Cue 1 contains Luminaire 1 and Luminaire 2.

A different timing value can be applied to each of Luminaire 1's parameters. For instance, Focus = 2:00, Edge = 00:30, Zoom = 1:30, and Color = 00:15.

Different timing values can be applied to Luminaire 2's parameters. For instance, Focus = 4:00, Edge = 03:30, Zoom = 2:45, and Color = 01:15.

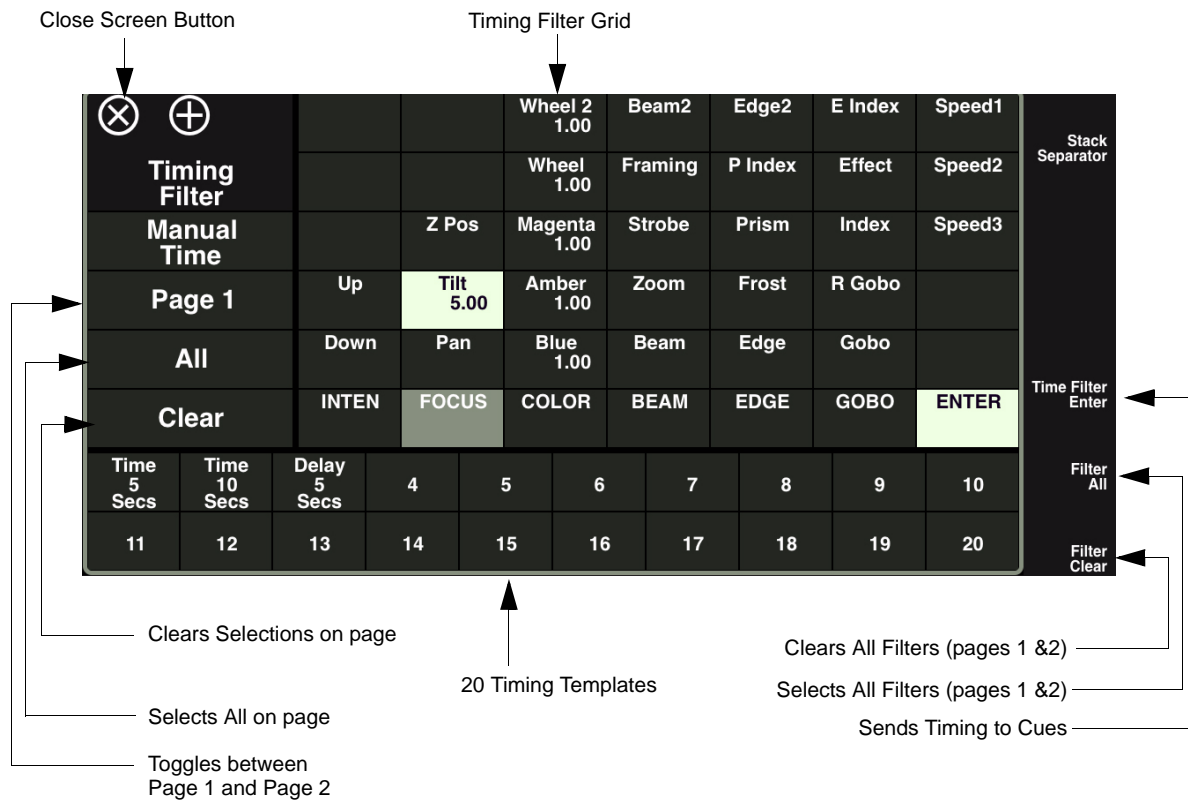





## Time/Speed Formats

### Time

Time controls the duration of change for any parameter.

#### *Guidelines:*

- + Each parameter can have an individual time.
- + Intensity can have both an up and down fade time. The direction of the intensity transition at the time of playback determines which of those two values is used.
- + Cue timing includes the movement of longest duration (combination of delay and time) and the longest intensity transition (combination of delay and up/down fade time).
- + Filtered values contribute to these times.
- + Masked values do not contribute to these times.
- + A parameter cannot have both a time and a speed although it can have a time and delay, *or* speed and delay.

Time is entered at the keypad in minutes and seconds, seconds, or seconds and tenths of seconds. (Maximum time entry is 59:59.)

#### **Entering whole numbers will be interpreted as total seconds:**

- + [2] [5] = 25.00 (25 seconds)
- + [9] [0] = 90.00 (90 seconds)

#### **A colon (:) is entered by pressing [.] [.]**

- + [2] [.] [.] [5] = 2:05 (2 minutes, 5 seconds)

#### **Fractions of seconds are entered by pressing [.]**

- + [1] [.] [3] = 1.3 (1.3 seconds)
- + [.] [5] = .5 (1/2 second)
- + [3] [5] [.] [5] = 35.5 (35 and 1/2 seconds)

### Delay

Delay time begins counting from cue execution and delays the playback of any parameter.

### Speed

Speed is the rate of change for any parameter.



## Timing Filter Operation

The Timing Filter is used to define an entire timing scheme, which can then be sent to selected luminaires using the `<Time Filter Enter>` button. The Timing Filter is also used to specify the target of timing entries made at the command-line keypad. When the Timing Filter is selected, current timing, delay, and speed information is displayed within the cell of its associated parameter.

### Guidelines:

- + Pressing the `<Time Filter Enter>` button sends all parameter timing values to selected luminaires whether the parameter is selected (highlighted) or not.
- + Entries made at the keypad will be sent directly to any parameters selected (highlighted) in the Timing Filter. For example, if "Blue" is selected at the Timing Filter and a command-line entry such as `[Time] [5] [Enter]` is made, then the time value will be sent directly to the mechanism mapped to the Blue encoder of any selected luminaires. De-selected parameters in the Timing Filter would not receive this value.

Use the examples below to send all values in the Timing Filter or individual values to luminaires as required.

### Set an entire timing scheme:

- Step 1. At Timing Filter, select a parameter(s).
- Step 2. At keypad, press `[Time]` or `[Delay/Speed]` as required, followed by time value. Time value will appear in cells of selected parameters.
- Step 3. Repeat steps 1 and 2, selecting different parameters and entering new values.
- Step 4. Select channels as required.
- Step 5. Press `<Time Filter Enter>` button to send all values.

### Send a timing value directly to a selected parameter:

- Step 1. Select channels as required.
- Step 2. At Timing Filter, select a parameter.
- Step 3. At keypad, press `[Time]` or `[Delay/Speed]` as required, followed by time value and then `[Enter]`. Time value will appear in cell of selected parameter at screen/window and be sent directly to selected channels. \*

### Clear Timing Filter of all values:

If timing values are cleared (as opposed to zero), existing timing information for that parameter in the luminaire will be left intact upon pressing `<Time Filter Enter>` button.

- + Press `<Filter Clear>`. All values will be cleared.

### An example of setting edge and focus timing:

- Step 1. Select channels as required.
- Step 2. `<EDGE> <FOCUS> [Time] [.] [5] [Enter]` - sets timing value for edge (edge, frost, effect, prism), and focus (pan, tilt) to one-half second.

### An example of setting focus delay time:

- Step 1. Select channels as required.
- Step 2. `<FOCUS> [Time] [1] [.] [0] [Delay/Speed] [.] [5] [Enter]` - sets the timing values for focus (pan, tilt) to 1 second with a one-half second delay. \*

### Set color delay time:

- Step 1. Select channels as required.
- Step 2. `<COLOR> [Time] [n] [Delay/Speed] [m] [Enter]` - sets all color timing to n seconds, with an m second delay. \*

\* Click `[Delay/Speed]` once for Delay and twice for Speed.



### Set intensity delay time:

Intensity timing can have two values: one which controls the intensity transition if the intensity is fading to a higher level (up time) and one which controls the transition if the intensity is fading to a lower level (down time).

Step 1. Select channels as required.

Step 2.  $\langle$ INTENSITY $\rangle$  [Time] [1] [.] [0] [Delay/Speed] [.] [5] [Enter] - sets the up and down times to 1 second, with a one-half second delay. \*

### Set intensity up or down time:

Step 1. Select channels as required.

Step 2. Select  $\langle$ Up $\rangle$  or  $\langle$ Down $\rangle$  to select one individually, then press [Time] [1] [.] [2] [Enter] - sets the up or down fade time to 1.2 seconds.

### Set intensity up and down time while storing a cue:

For this shortcut, the first Time entered is always Up and the second is Down.

Step 1. Select channels as required.

Step 2. Ensure all parameters at Timing screen are deselected.

Step 3. Press [Store] [Cue] [x] [Time] [m] [Time] [n] [Enter] - stores Cue x with an up time of m and a down time of n.

### Set timing back to zero:

Step 1. Select channels as required.

Step 2. At Timing Filter, select a parameter.

Step 3. Press [Time] [0] [Enter].

\* Click [Delay/Speed] once for Delay and twice for Speed.

**Tip**  $\Rightarrow$  Time and delay values stay in a luminaire until changed or set back to zero. Use the Luminaire Status window with time ( $\oplus$ ) selected to view current timing and delays. To clear delay timing, select channel and appropriate parameters in the Timing window and set delay to 0. (Refer to "[Luminaire Status Window](#)" on page 78.)

## Fanned Timing and Delays

Timing and delay attributes can be "fanned" into channel selections using the soft encoders or command-line keypad. This function works in conjunction with the Function Filter. The parameter you are working with *must* be selected in the Function Filter.

---

**Note:** Also refer to "Fan" on page 71.

---

### From Encoder

- Step 1. Using Function Filter, set parameter filters.
- Step 2. At soft encoder window, turn Fan on by holding down [Fan] button or double-clicking [Fan] button.
- Step 3. Select required channels.
- Step 4. Rotate encoder to set value.

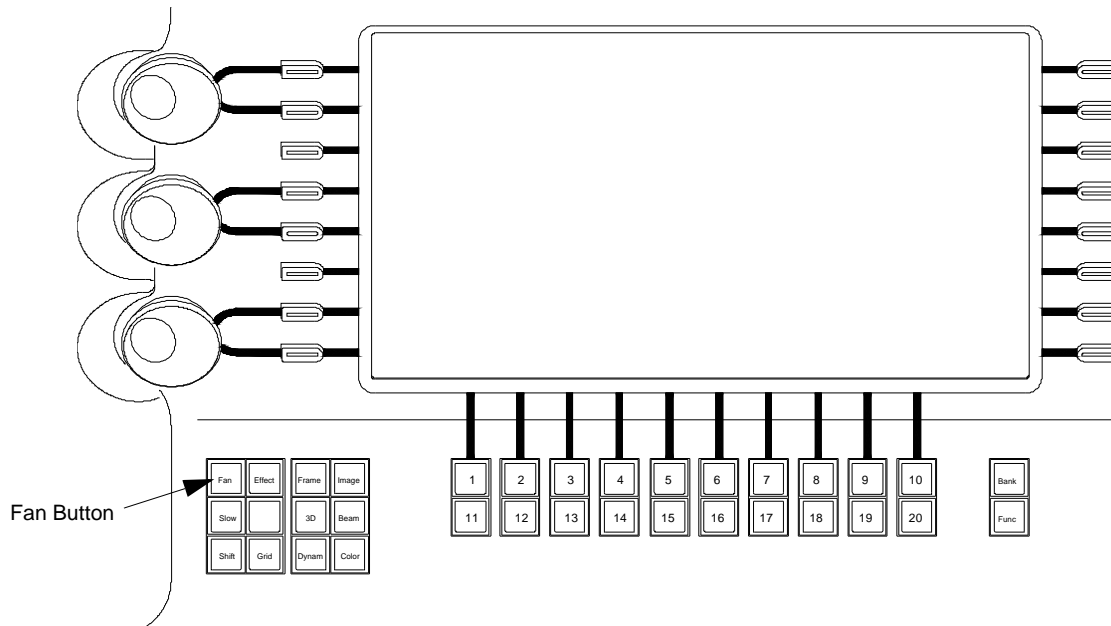

---

**Note:** The V676 console is shown in this example, however, this button is found on all Vx76 console front panels.

---

Figure 4-1: Fan Button

### From Keypad

- Step 1. Using Function Filter, set parameter filters.
- Step 2. Select required channels.
- Step 3. Press [Time]\* [m] [Thru] [n] [Enter] - evenly distributes the time setting across the channel selection *m* through *n*.

\* [Delay] can be used instead of [Time]

*Example:*

[Time] [1] [Thru] [6] [Enter] - fans time across current channel selection, following fan type, with the first channel starting at 1 second and the last channel starting at 6 seconds.

# FUNCTION FILTER

## Overview

The Function Filter is used to withhold (or mask) certain parameters or parameter attributes from a preset or a cue, and to control what is recalled in a submaster.

**Important!** It is important to note the exact meaning of the term "filter" as it pertains to console operation. When a parameter is *not filtered* (i.e. selected/highlighted at the Function Filter screen), its data would be transferred during any subsequent store or recall operations. When a parameter is *filtered* (i.e. *not* selected/highlighted), its data would be withheld from a data transfer. This is represented graphically in the following illustration:

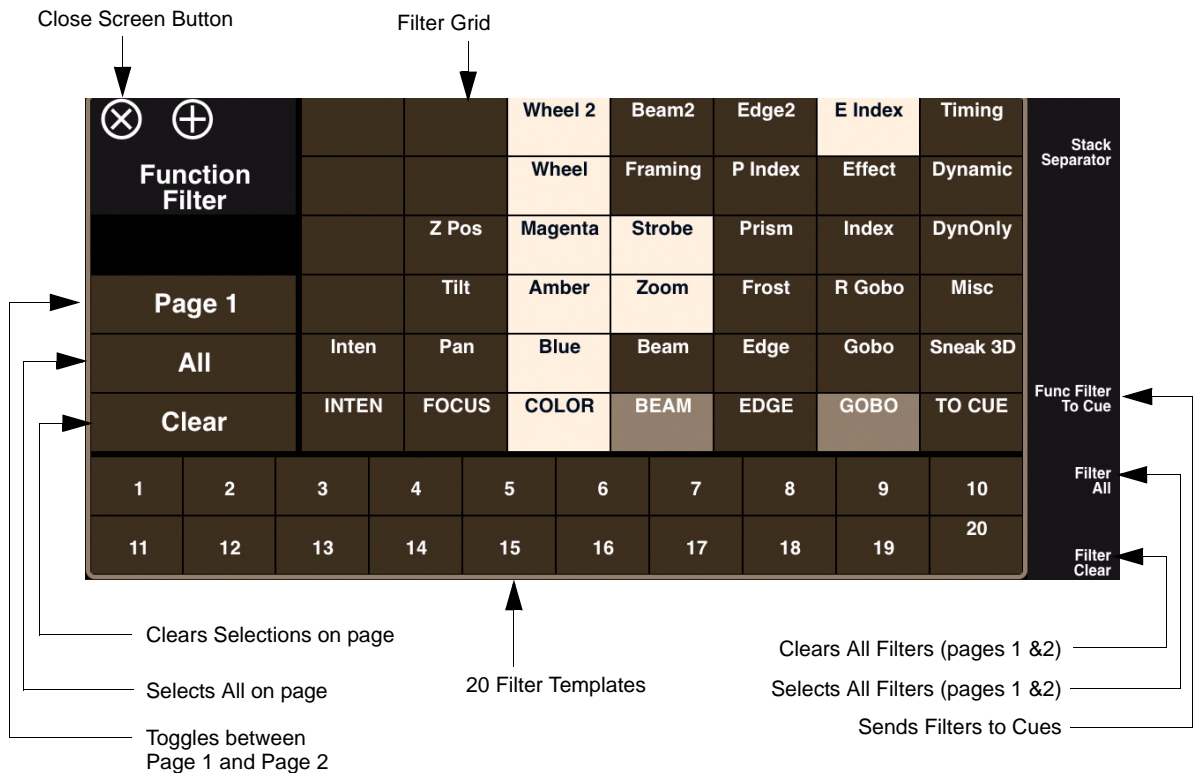
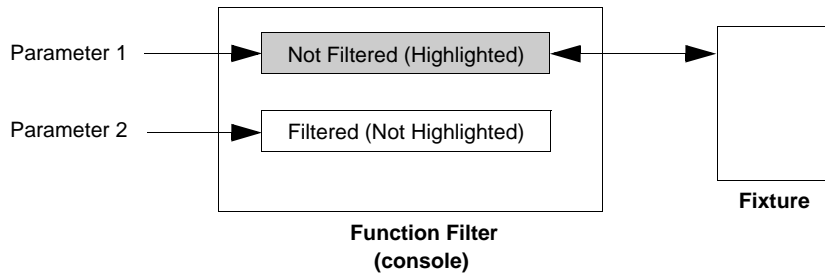



*Filter Guidelines:*

- + The timing filter is globally applied, not individually for each parameter. When a parameter is filtered, its time is also filtered. This is always true except if a Selective Store is performed with only time selected. In this case you will get all the times for all parameters.
- + Filters affect selective store and selective recall commands (refer to "[Selective Store](#)" on page 260 and "[Selective Recall](#)" on page 261).
- + Filters have no affect on the recall of presets or update commands (refer to "[Update](#)" on page 258).
- + Filters have no affect on the playback of cues, unless those filters have been applied to a submaster (refer to "[Function Filter \(Submaster\)](#)" on page 298).
- + The Function Filter screen does not have to be visible for selected filters to affect console operation. For this reason, the touchscreen provides an indication that filters are selected by highlighting them in the parameter grids located at the bottom left of the touchscreen, in the command-line display, and in the submaster displays.

## **Masking**

When a filter is applied during a cue store operation, values for all parameters are stored, although some have been excluded from playback (filtered). This method of filtering utilized by the console is called "masking." It is important to keep this concept in mind when storing cues with filters because during some playback situations, the values which were "masked" can intentionally or unintentionally be recalled. This situation can occur when a filter or ""mask" has been applied to a cue and a second filter is applied to the submaster which is playing back that particular cue. Refer to "[Function Filter \(Submaster\)](#)" on page 298 for information on playing back cues which have stored masks.

## Function Filter Operation

When the Function Filter is accessed, by default, all parameters are selected (not filtered). Change filtering for parameters as follows:

- + To prohibit the store or recall of all attributes of a parameter, use the main category button (such as FOCUS, COLOR, BEAM, etc.) to deselect all.
- + To prohibit the store or recall of one attribute of a parameter (zoom, for example), select the appropriate cell on the screen to deselect.

The parameter grids visible at the command-line display and submasters display indicate the filtered (or non-filtered) state of each parameter. The <Function Filter To Cue> button must be pressed before the command-line or submasters grids will reflect the filter settings.

- + When none of a parameter's (I, F, E, C, B, G) attributes are filtered, its box is highlighted.
- + When some of a parameter's attributes are filtered, the box is gray.
- + When all of a parameter's attributes are filtered, its box is clear.
- + After adjusting the filter settings, the filters can be applied to preset or cue store and playback functions.



### Applying Filters To Cues

The <Function Filter To Cue> button is used to apply filters to a cue store operation.

#### Using filters while storing cues:

- Step 1. Set filters as required.
- Step 2. Press <Function Filter To Cue> button. The filter state will be applied to all cues stored from this point on, until changed.
- Step 3. Store cue as usual (refer to ["Storing Cues"](#) on page 141).

### Applying Filters To Beam Palette

Filters can be applied to Beam palette store operations. Beam palettes will store information based on the filters set in the Beam, Gobo, and Edge columns of the Function Filter.

### Applying Filters To Color Palette

Filters can be applied to Color palette store operations if the system default setting is changed accordingly. Refer to ["System-Wide Palette Store Options"](#) on page 105 for instructions on setting this default. Store colors as usual, using filters as required.

### Applying Filters To a Submaster

When a filter is applied to a submaster, the associated parameter data will be withheld from playback in the case of an effect or unmasked cue. Applying a filter to a submaster may force the playback of masked parameters of a cue.

Refer to ["Function Filter \(Submaster\)"](#) on page 298 for instructions on using the submaster Function Filter feature.

# SNEAK

## Overview

The Sneak feature works in conjunction with the command-line keypad to provide manual control of luminaires. Sneak provides a means of creating manual control moves "on-the-fly." Attribute values, presets, color, beam, and cue data can all be assigned to parameters and then recalled using manual time or speed, or by pressing Enter. This allows you to "sneak" in a move, not originally programmed, during programming or the playback of a show.

Sneak can be done using either the Timing Filter or Function Filter.

⊗ ⊕				Wheel 2 1.00	Beam2	Edge2	E Index	Speed1	Stack Separator	
Timing Filter				Wheel 1.00	Framing	P Index	Effect	Speed2		
Manual Time		Z Pos		Magenta 1.00	Strobe	Prism	Index	Speed3		
Page 1		Up	Tilt 5.00	Amber 1.00	Zoom	Frost	R Gobo		Time Filter Enter	
All		Down	Pan	Blue 1.00	Beam	Edge	Gobo			
Clear		INTEN	FOCUS	COLOR	BEAM	EDGE	GOBO	ENTER		
Time 5 Secs	Time 10 Secs	Delay 5 Secs	4	5	6	7	8	9	10	Filter All
11	12	13	14	15	16	17	18	19	20	Filter Clear

⊗ ⊕				Wheel 2	Beam2	Edge2	E Index	Timing	Stack Separator	
Function Filter				Wheel	Framing	P Index	Effect	Dynamic		
		Z Pos		Magenta	Strobe	Prism	Index	DynOnly		
Page 1		Tilt		Amber	Zoom	Frost	R Gobo	Misc	Func Filter To Cue	
All		Inten	Pan	Blue	Beam	Edge	Gobo	Sneak 3D		
Clear		INTEN	FOCUS	COLOR	BEAM	EDGE	GOBO	TO CUE		
1	2	3	4	5	6	7	8	9	10	Filter All
11	12	13	14	15	16	17	18	19	20	Filter Clear





## Sneak Values

Sneak values are entered numerically at the keypad using the [Sneak] button. Use discrete numbers from the following ranges for parameter values:

Function	DMX512 Value
Intensity	0-100
Pan*	0-65535
Tilt*	0-65535
Blue	0-255
Amber	0-255
Magenta	0-255
Color Wheel	0-255
Gobo Wheel	0-255
Gobo Index	0-255
Rotating Gobo	0-255
Beam	0-255
Zoom	0-255
Edge	0-255
Frame	n/a
Strobe	0-255

\* Pan and Tilt sneak values can only be entered in the value range 0-1023. For luminaires with a larger range, the sneak value will be converted and will display correctly in the Luminaire Status window. Home position = 512.

---

**Note:** Sneak does not work with shifted parameters.

---



## Sneak Operation

Sneak values are entered using the [Sneak] button and either the Timing Filter *or* Function Filter screen. After the sneak operation has been defined, pressing the Timing Filter's <ENTER> button or the Function Filter's <TO CUE> button will cause all selected luminaires to move into the new position as defined by the values. The values are entered numerically at the keypad.

### Perform a sneak action using current timing information:

- Step 1. Select channels as required.
- Step 2. Bring up either Timing Filter *or* Function Filter screen.
- Step 3. Select parameter to be changed.
- Step 4. At keypad, press [Sneak] and enter required value, press [Enter].
- Step 5. At filter, select next parameter and enter its value using keypad.
- Step 6. When finished, press Timing Filter's <ENTER> button *or* Function Filter's <TO CUE> button. Selected luminaires will move into the new position as defined by the values.

### Sneak to a preset (same for color and beam):

- Step 1. Select channels as required.
- Step 2. Bring up either Timing Filter *or* Function Filter screen.
- Step 3. Select parameter to be changed.
- Step 4. At keypad, press [Sneak] [Preset] [x] [Enter] (where x is the discrete preset number) *or* press and hold [Sneak] while pressing <Preset Palette Button>.
- Step 5. Press Timing Filter's <ENTER> button *or* Function Filter's <TO CUE> button. Selected luminaires will move into the new position as defined by the preset data.

### To Sneak Cue data:

- Step 1. Select channels as required.
- Step 2. Bring up either Timing Filter *or* Function Filter screen.
- Step 3. Select parameter to be changed.
- Step 4. At keypad, press [Sneak] [Cue] [x] [Enter] (where x is discrete cue number).
- Step 5. Press Timing Filter's <ENTER> button *or* Function Filter's <TO CUE> button. Selected luminaires will move to the cue selected.

---

**Note:** Cue numbers with decimals can be entered into sneak. For example, [Sneak] [Cue] [1] [.] [3] [Enter] will enter Cue 1.3 into the selected parameter. Even cues without a decimal value will be displayed as a decimal value (1 is 1.00).

---

**Note:** Sneak cue data will recall data only for the selected parameters from the given cue, which can be used as a selective recall tool.

---

### Perform a sneak action using new timing information:

- Step 1. Select channels as required.
- Step 2. Bring up either Timing Filter *or* Function Filter screen.
- Step 3. Select parameter to be changed.
- Step 4. At keypad, press [Sneak] and enter required value, press [Enter].
- Step 5. To enter time, press [Sneak] [Time] and time value. Press [Enter].
- Step 6. Press Timing Filter's <ENTER> button *or* Function Filter's <TO CUE> button. Selected luminaires will move to their new values using their time settings.

*Examples:*

- + Pan [Sneak] [Time] [2] [Enter] will input a time of 2.00 seconds.
- + Pan [Sneak] [512] [Time] [2] [Enter] will input the value 512 into Pan with a time of 2.00 seconds.
- + Pan [Sneak] [512] [Time] [2] [.] [.] [Enter] will input the value 512 into Pan with a time of 2:00 minutes.
- + Pan [Sneak] Cue [10] [Enter] will input cue data from Cue 10 into Pan.
- + Pan [Sneak] [Speed] [20] [Enter] will input a speed of 20.

### Sneak 3D

The Sneak 3D fields, available at the Function Filter, allows direct entry of 3D X, Y, and Z values. Sneaking to a 3D position works just like sneaking to other parameters.

⊗ ⊕				WhiCtrl	--	--	G2 Mod	Timing	
Function Filter				Wheel	Framing	--	Gobo2	Dynamic	
				--	Magenta	Shutter	--	G1 Mod	DynOnly
Page 1				Tilt	Yellow	Zoom	Frost	Gobo1	Misc
All		Intensl	Pan	Cyan	Beam	Edge	--	Sneak3D	
Clear		INTEN	FOCUS	COLOR	BEAM	EDGE	GOBO	TO CUE	
1	2	3	4	5	6	7	8	9	10
11	12	13	14	15	16	17	18	19	20

⊗ ⊕					--		G2Mctrl	Control	
Function Filter					--	--	G2 Ctrl	--	
				--	MagCtr	--	G1Mctrl	--	
Page 2				--	YeloCtr	--	G1 Ctrl	Sneak Z	
All				--	CyanCtr	--	--	Sneak Y	
Clear		INTEN	FOCUS	COLOR	BEAM	EDGE	GOBO	Sneak X	
1	2	3	4	5	6	7	8	9	10
11	12	13	14	15	16	17	18	19	20

*Example:*

- Step 1. At Function Filter, select desired field, such as <Sneak X>.
- Step 2. At command-line keypad, enter a Sneak command, such as [Sneak] [0] [Enter].

---

**Note:** Negative values are permitted for 3D parameters.

---

## Sneak Value or Percent

Sneaks can be done by value or by percentage using either the command-line or direct-entry methods.

### Using Command Line

When using the command line, the type of entry (Value or Percent) is based on the Parameter setting in the console Settings/General window. Refer to "**General Tab**" on page 306. In this case, enter a sneak command as usual, such as [Sneak] [#] [Enter] - where the # is either a value or percentage based on the Parameter setting.

### Using Encoder Sidebar

When using the Encoder Sidebar, press a parameter. At the numeric keypad, select either Value or Percent by pressing the appropriate button.

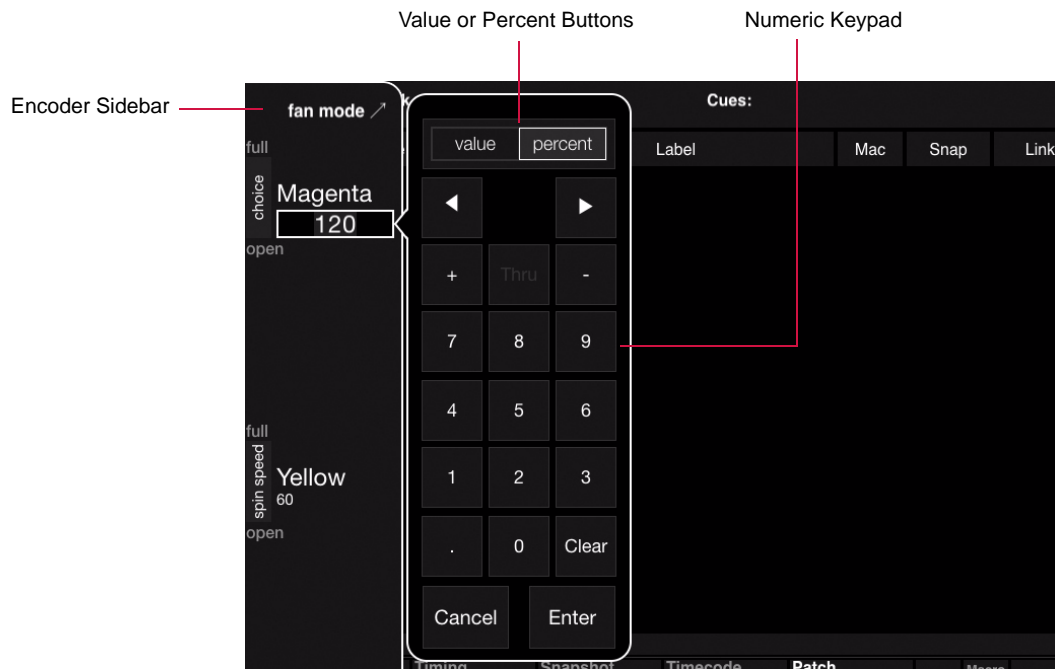

## Direct Sneak To Parameters

Direct sneak to parameters is possible by holding [Sneak] while pressing a parameter in the Encoder Sidebar.



# TEMPLATES

## Timing/Filter Templates

The template section, found at the bottom of both the Timing Filter and Function Filter, provides 20 programmable templates that can be used to store frequently used settings.

⊗ ⊕				Wheel 2 1.00	Beam2	Edge2	E Index	Speed1	
Timing Filter				Wheel 1.00	Framing	P Index	Effect	Speed2	
Manual Time			Z Pos	Magenta 1.00	Strobe	Prism	Index	Speed3	
Page 1		Up	Tilt 5.00	Amber 1.00	Zoom	Frost	R Gobo		
All		Down	Pan	Blue 1.00	Beam	Edge	Gobo		
Clear		INTEN	FOCUS	COLOR	BEAM	EDGE	GOBO	ENTER	
Time 5 Secs	Time 10 Secs	Delay 5 Secs	4	5	6	7	8	9	10
11	12	13	14	15	16	17	18	19	20

Template Palette Buttons

## Storing and Recalling Templates

### Store a new template:

- Step 1. At Timing Filter or Function Filter, set parameters as desired.
- Step 2. Press and hold [Store] while pressing <Template Palette Button>. The settings will be stored.

### Label a template:

When labeling, the name can be entered on the console touchscreen keyboard or computer keyboard.

- Step 1. Press and hold [Label] while pressing <Template Palette Button>.
- Step 2. Enter alpha/numeric label.

### Recall a template:

- Step 1. Select Timing Filter or Function Filter as required.
- Step 2. Press <Template Palette Button> to recall a template.
- Step 3. Press <Time Filter Enter> or <Function Filter To Cue> as appropriate to send values to luminaires.



## Notes



## 5.

# PALETTES

This chapter provides instructions for using the Palettes feature.

- + GENERAL PALETTE OPERATION
- + PRESETS
- + COLORS
- + BEAMS
- + GROUPS
- + OTHER PALETTE TYPES
- + DESKTOP PALETTES WINDOW

# GENERAL PALETTE OPERATION

---

## Overview

### What are Palettes?

A *palette* is a pre-stored or user-defined set of parameters (presets, colors, beams), selections (groups, snapshots, cue stacks) or events (macros, effects, dynamics). Palettes can be used to simplify channel selection, manual control of luminaires, cue and effect creation, event recall, and to ensure consistency of cue parameters throughout the cue list.

There are three ways to access and edit the information which is stored in the palettes:

- + The first is by using the palette touchscreens located on the front panel (V476/V676 only). Each of the dedicated display banks can be configured to show any combination of Presets, Colors, Beams, Groups, Macros, Snaps (Snapshots), Effects, Dynamics and Stacks (Cue Stacks).
- + The second is by using the Palettes window available at the **Operations** menu. This window allows the same store, update and recall features as the front panel touchscreens.
- + Parameters stored into the palette banks can also be recalled from the command-line keypad. (Instructions for using the keypad are included in the appropriate sections on storing, modifying and recalling Beams, Colors, Groups, etc.) All storable palette items have a discrete number which is used to access the feature from the keypad. The palette items maintain this number, even when given another label. For example, if a focus parameter is stored into Preset 1 and relabeled as "Home" it would still be recalled at the keypad by pressing [Preset] [1] [Enter].

The screen capture below shows an example of the Beam palette:

Beam	Bank 1				Fixed	Page 2	Page 3	Page 4	Page 5
1 Open	2 Pebbles	3 Breakup	4 Night Sky	5 Leaves	6 Vert Bar	7 Tribal	8 Blocks	9 Sqiggle	10 Card board
11 Horzon Lines	12 Spin	13 Fast Spin	14	15	16	17	18	19	20

---

**Note:** Some DMX profiles have, as a default, the full-frame wheel positions. Color mixing is not supported in the color palette as a default, but may be added to the palette as needed.

---



## System-Wide Palette Store Options

The System Settings window provides options for system-wide palette store operations. These settings are:

- + **Lowest Active Device** - draws data from the lowest channel number with intensity of that type, regardless of selection.
- + **Lowest Selected Device** - draws data from the lowest selected channel number of that type, regardless of intensity state.
- + **Use Function Filter on Color Store** - when checked, Color store operations will be affected by the function filter. Refer to "[Function Filter](#)" on page 93.

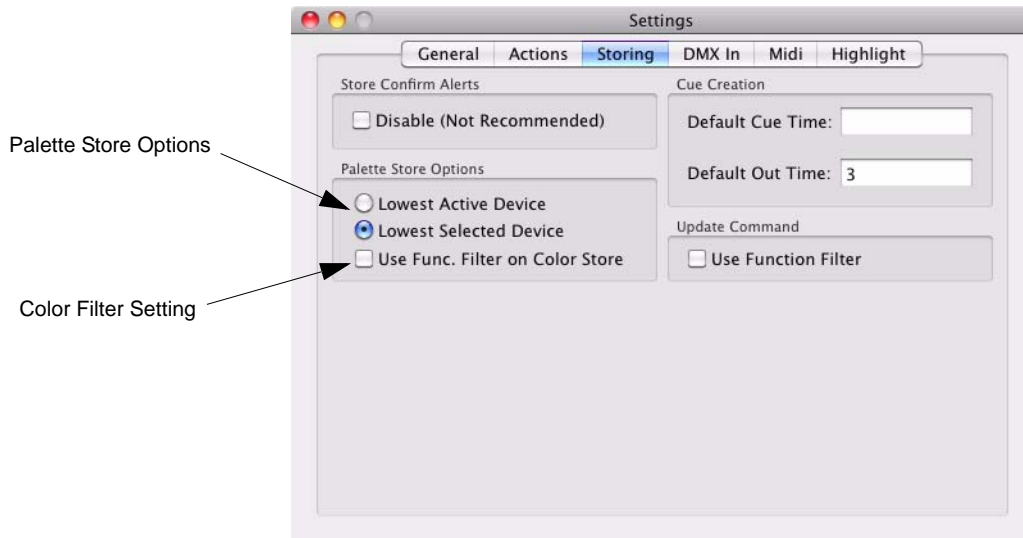

---

**Note:** For more information about the Setting window, refer to "[Settings Window](#)" on page 306.

---

## Front Panel Palette Displays (V476/V676 Only)

The V676 front panel contains three (3) full palette displays and one (1) single palette area above the submasters.

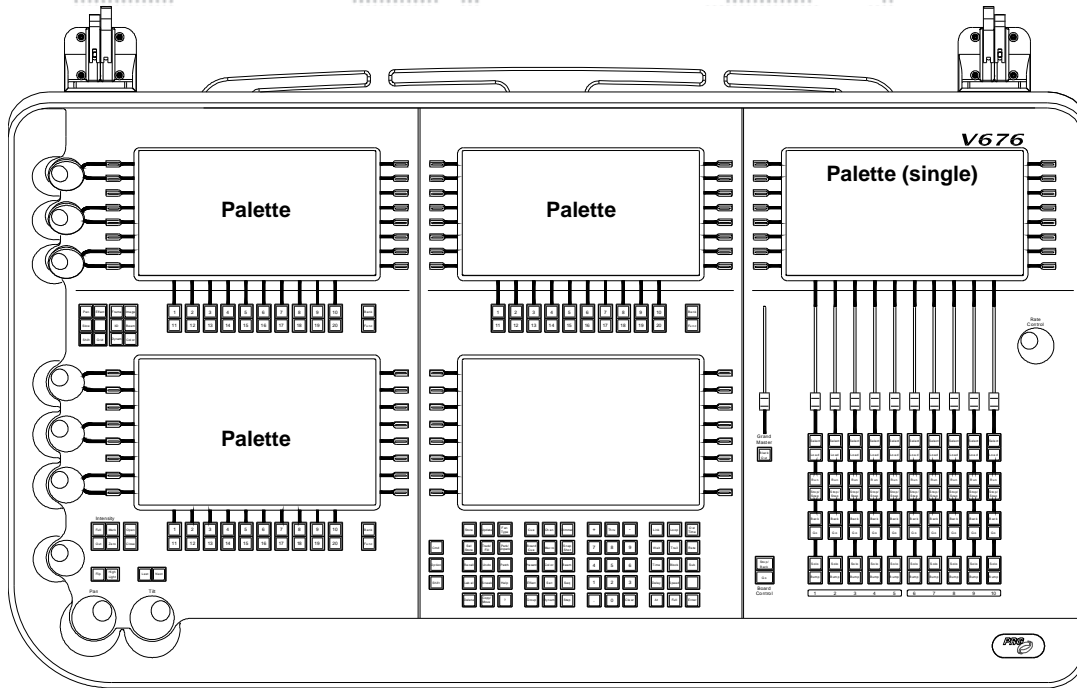

Figure 5-1: V676 Front Panel

The V476 front panel contains one (1) full palette display and one (1) single palette area above the submasters.

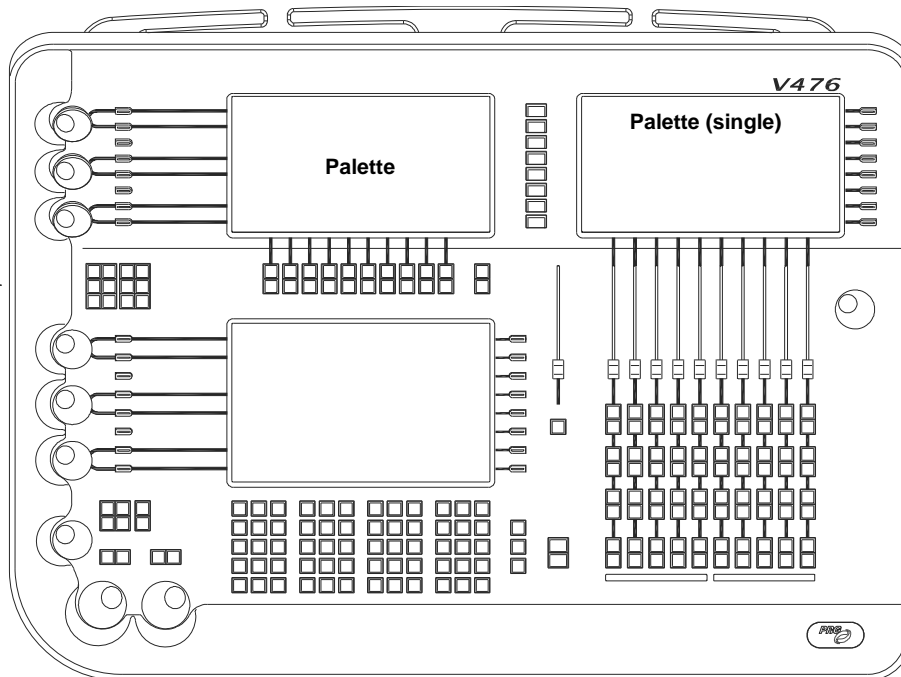

Figure 5-2: V476 Front Panel

20 physical buttons (labeled 1 through 20) are provided below each palette display. These work in combination with the palette located in the lowest position of the display. This provides a "hard button" alternative to the touchscreen.

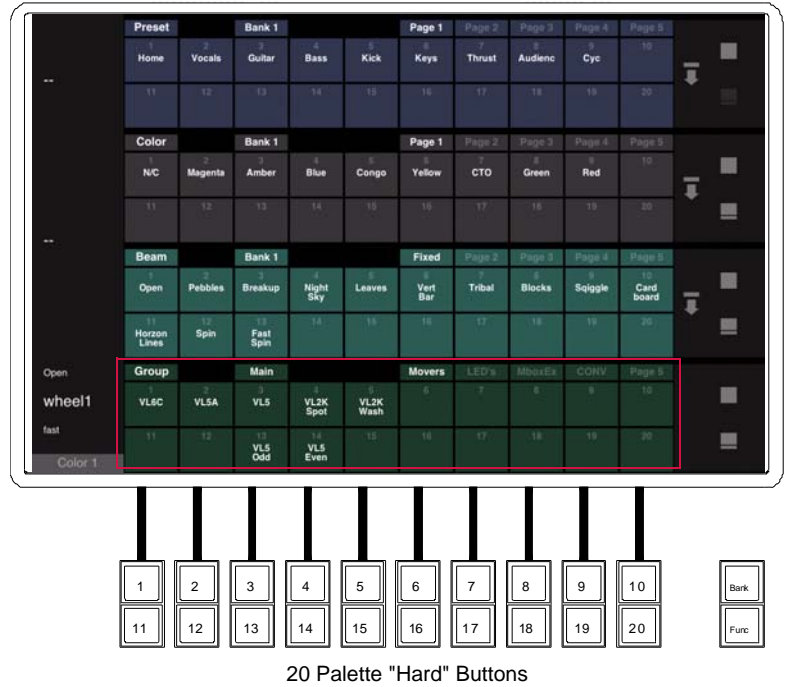

Figure 5-3: V476/V676 Palette Buttons

## Desktop Palettes Window

Palettes can also be viewed in the desktop windows by selecting **Palettes** from the **Operation** menu. These window palettes are fully functional and scalable, with the same 4x20, Century, and Super palette views found in the front panel of the V476 and V676 consoles. (For the V276 On Mac console, this is the only method of working with the palettes.)

### Guidelines:

- + Multiple instances of the palettes may be opened on the desktop.
- + Each instance is scalable by dragging the bottom-right corner, and snappable just like any other desktop window.

The screenshot shows the 'Palettes' window with a menu on the left and a 4x20 grid of items on the right. The menu is divided into sections: Operation, Data, Special, Palettes, Command HUD, and Pan/Tilt Control. The grid is organized into four sections: Macro, Snaps, Dynamic, and Stack. Each section has a 'Bank 1' header and a 'Page 1' header. The items are arranged in a 4x20 grid with columns numbered 1 to 20. On the right side of the grid, there are three sets of window control icons (minimize, maximize, close) corresponding to the four sections.

Operation			Data	Special
Cue Sheet				
Board Cue Sheet				
Plan View				⌘B
3D Graphic				⌘G
Luminaire Status				⌘S
Tracking Changes				⌘S
Intensity				⌘I
Timecode				
Palettes				
Channel Select				
Century Palette				
Timing/Filter Display				
276 Display				
Command HUD				
Submaster HUD				
Encoder HUD				
Pan/Tilt Control				⌘; ⌘'
X/Y Control				

Palettes																			
Macro		Bank 1				Page 1					Page 2	Page 3	Page 4	Page 5					
1	Time Code Enable	2		3		4		5		6		7		8		9		10	
11		12		13		14		15		16		17		18		19		20	
Snaps		Bank 1				ACT 1					Page 2	Page 3	Page 4	Page 5					
1	Default Setup	2	Song One	3	Song Two	4	Song Three	5		6		7		8		9		10	
11		12		13		14		15		16		17		18		19		20	
Dynamic		Bank 1				Page 1					Page 2	Page 3	Page 4	Page 5					
1	Bally Slow	2	Bally Medium	3	Bally Fast	4	Circle Slow	5	Circle Fast	6	Fig 8 Slow	7	Fig 8 Fast	8	Roller Slow	9	Roller Fast	10	Stop All Dynamic
11	Inten Fade	12	Inten Bump	13	Color Wheel Rock	14	Color Wheel Roll	15	Iris	16	Zoom	17	Col Mix Fade Slow	18	Col Mix Fade Fast	19	Col Mix Bump Slow	20	Col Mix Bump Fast
Stack		Bank 1				Page 1					Page 2	Page 3	Page 4	Page 5					
1	Main Cues	2	Guitar Solo	3	House Special	4		5		6		7		8		9		10	
11		12		13		14		15		16		17		18		19		20	

## General Operation

No matter whether you are using the front panel displays or software window, the palette operation is the same.



### To move a palette into bottom position:



Press the arrow button to the right of the palette to move it into the bottom position. (This will swap it with the palette that is currently in the bottom position.)

### To display as a century screen:



Press the Century button to display the 100-button array.

### To display a "super palette" editing screen:



Press the Edit button to display editing controls.

### To return to the standard layout screen:



Press the Standard Palette button to return to the 3-palette layout.

### To apply a stored setting to a selected channel:



Press an individual palette button.

## Century Palette Screen

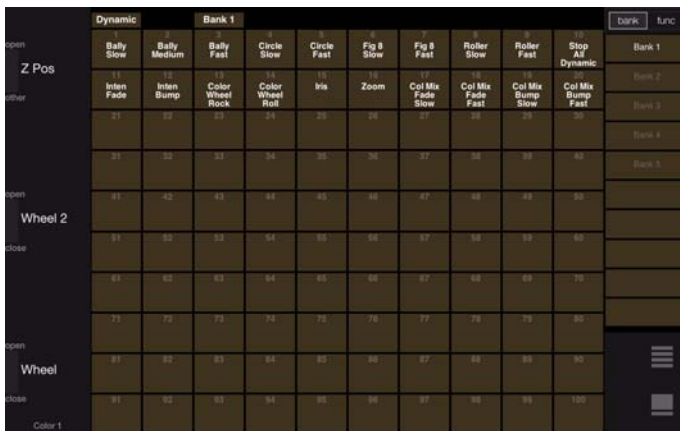

## Super Palette Screen

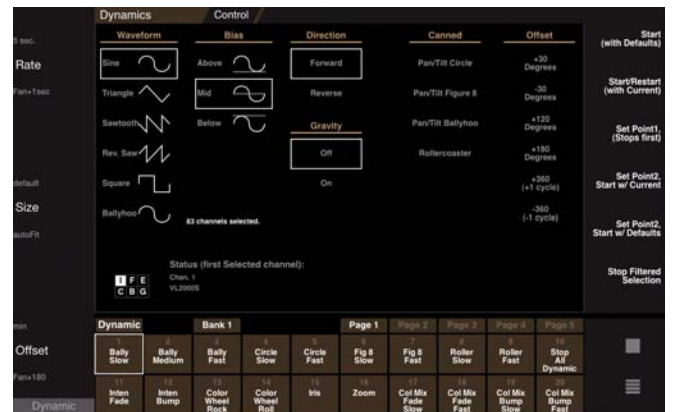

**To access a different palette:**

- Step 1. Press and hold the currently selected function to display all options.
- Step 2. Select Preset, Color, Beam, Group, etc. by pressing the corresponding button on the touchscreen.

For example, press <Beam> as shown below to bring up options, then press <Color>. The Color palette will become the new selection.

Currently Selected Function (press to bring up options)

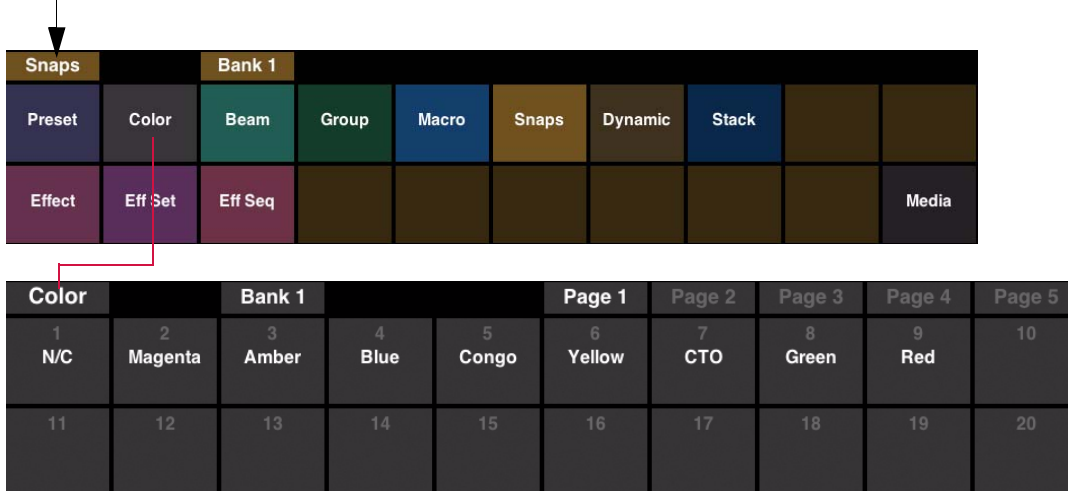

**To access a different page within a display:**

Press desired page button at top of palette.

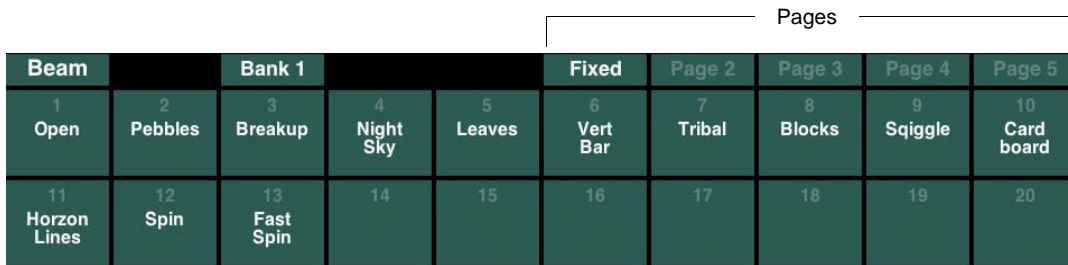

**To access a different bank within a display:**

Press and hold [Bank] button while pressing the desired Bank: <Bank 1>, <Bank 2>, <Bank 3>, etc.

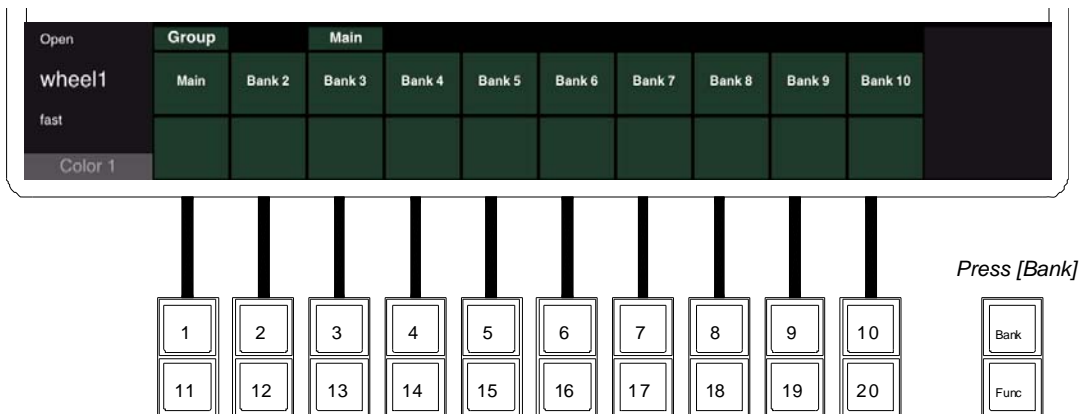

### To store a setting:

- Step 1. Select required channels.
- Step 2. Ensure the target function is selected on at least one palette (for example, Beam as shown below).
- Step 3. Using manual controls, set all required parameters.
- Step 4. Filter attributes as required.
- Step 5. Press and hold [Store] while pressing <Palette Button>. (The store action will be confirmed by changing the default number to white *unless* a label is specified.)

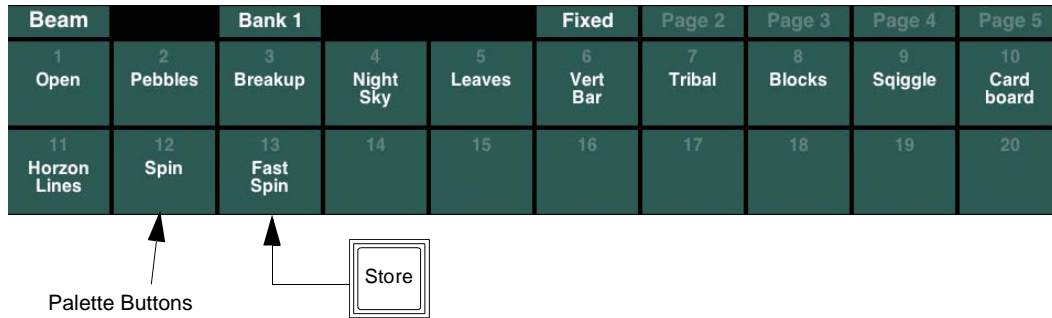

### To apply stored settings:

- Step 1. Select required channels.
- Step 2. Access required function (for example, Beam as shown below).
- Step 3. Access required bank by pressing and holding [Bank] button while pressing the desired Bank: <Bank 1>, <Bank 2>, <Bank 3>, etc.
- Step 4. Access required page by pressing any one of five page buttons.
- Step 5. Press individual <Palette Button> to apply settings. Selected luminaires will change.

For example, to apply a pre-stored Fast Rotation parameter to a luminaire, first select the channels to include. Then locate the required palette button (59 - Fst Rot, as shown below). When this button is pressed, the settings will be sent to the selected channels.



**Tip** ⇨ To store the palette *and* bring up the label dialog, press and hold [Store] / [Label] and <Palette Button> at the same time.

## Palette Labels

### Applying Labels to Palettes

Each palette may be given a custom label. When labeling, the name can be entered on the console touchscreen keyboard *or* computer keyboard.

#### To label a bank, page, or palette:

For all storable items, the default label (number) will move from the middle to the top line of the palette button when something has been stored in it.

Step 1. Press and hold [Label] while pressing any bank, page, or palette button.

Step 2. Enter alpha/numeric label.

Beam		Bank 1			Fixed	Page 2	Page 3	Page 4	Page 5
1 Open	2 Pebbles	3 Breakup	4 Night Sky	5 Leaves	6 Vert Bar	7 Tribal	8 Blocks	9 Sqiggle	10 Card board
11 Horzon Lines	12 Spin	13 Fast Spin	14 14	15 mylabel	16	17	18	19	20

Stored w/ Label

Stored w/o Label

Store	Update	Grab
Sel Store	Block/UnBlk	Park/Unpark
Recall	Undo	Patch
Label	Sneak	Manual/Revert
Delete	Copy/Move	Query/Help

Empty

Touchscreen Keyboard

### Soft Keyboard Copy/Paste

Buttons for Copy and Paste are available on the soft keyboard. These can be used to copy the entire label to the clipboard or paste the clipboard to the label. The function also allows copy/paste from other sources.

Select multiple fields for copy by holding down the <shift> button. When multiple fields are pasted into a different label, they will go into the same "slots" (fields) as they came from.



## Label Shortcuts

Label Shortcuts allow a user to create a selection of commonly used words that can be used to quickly create new labels.

### To store a selection:

- + Select desired field and press [Store] / <User #> slot to store data into a shortcut field.  
For example, [Store] / <User 3> would store the data into the User 3 slot.

### To recall a selection:

- + Press a <User #> slot to bring the word into the current label field.

In the Palette Label keyboard, the entry box will move to the next field when a shortcut is pressed.

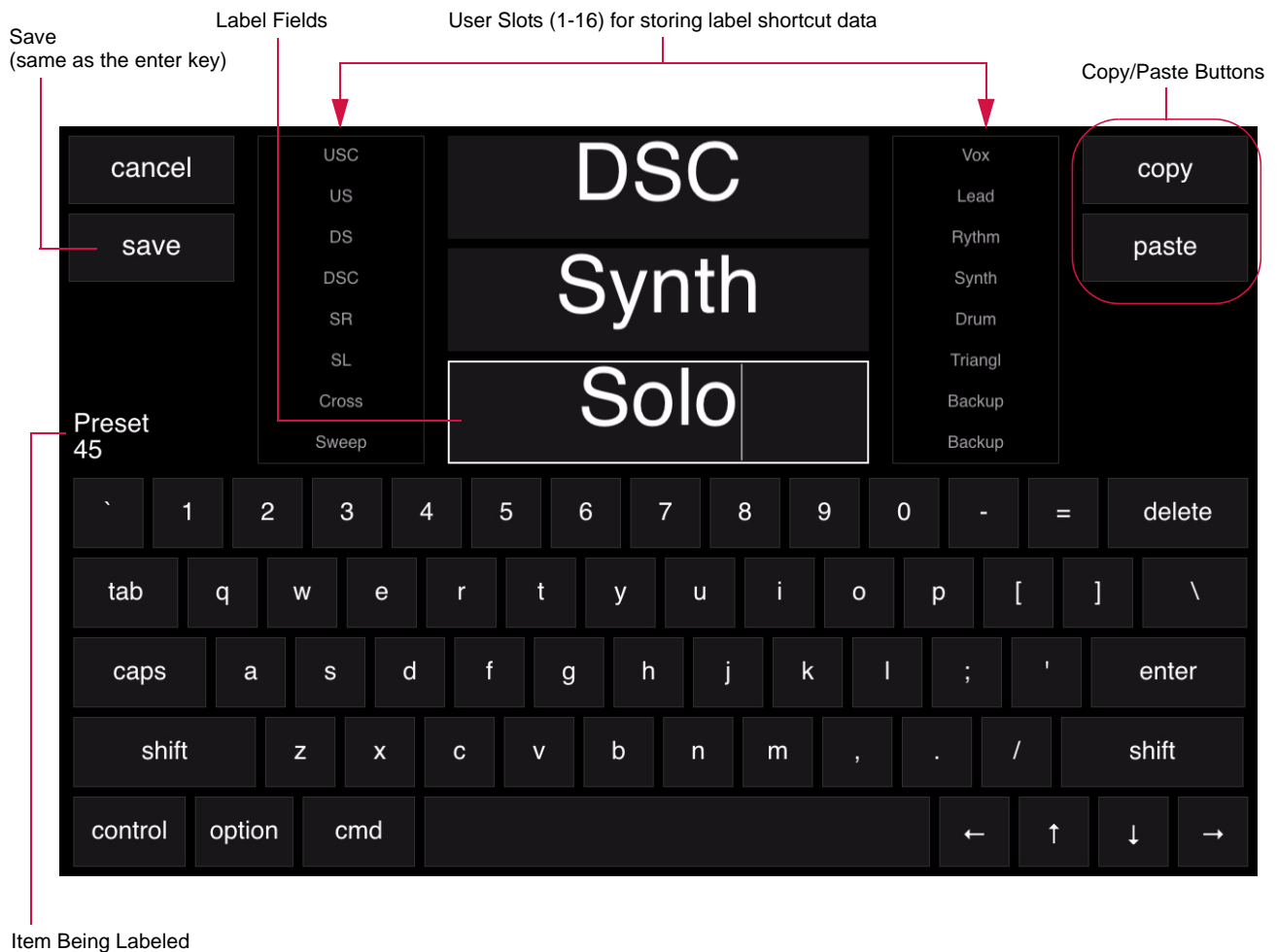

## Century Palette Window

The Century palette is a resizable window which displays a full bank of palettes.

To open Century palette window:

- + At Operation menu, select Century Palette.

The screenshot shows the Century Palette window with a menu on the left and a grid of 100 palettes. The menu includes options like Cue Sheet, Board Cue Sheet, Plan View, 3D Graphic, Luminaire Status, Tracking Changes, Intensity, Timecode, Palettes, Channel Select, Century Palette, Timing/Filter Display, 276 Display, Command HUD, Submaster HUD, Encoder HUD, Pan/Tilt Control, and X/Y Control. The palette grid is organized into 10 banks, with Bank 1 highlighted. Arrows point to the '100 Palettes' and 'Bank/Function Select' labels.

Macro	Bank 1										bank	func
1 Home	2 Home Inten Full	3 Park	4 Un-Park	5 Select Park	6 Divide By 2	7 Divide By 3	8 Divide By 4	9 At +5	10 At +10	Bank 1		
11 Mark Back 1 Cue	12 Mark Back 2 Cues	13 Sub 1 Hi Lite Off	14 Sub 1 Hi Lite Forward	15 Sub 1 Hi Lite Reverse	16 Palette Hi Lite Off	17 Palette Hi Lite Forward	18 Palette Hi Lite Reverse	19 At -5	20 At -10	Bank 2		
21 Cue Sheet	22 Board Cue Sheet	23 Media Window	24 Plan View Window	25 Luminar Status Window	26 Intens Window	27 Century Palette	28 Select Display	29 Timing Filter Display	30 3d Graphic	Bank 3		
31 Up Time 0 Sec	32 Up Time 1 Sec	33 Up Time 2 Sec	34 Up Time 3 Sec	35 Up Time 4 Sec	36 All Time 0 Sec	37 All Time 1 Sec	38 All Time 2 Sec	39 All Time 3 Sec	40 All Time 4 Sec	Bank 4		
41 Down Time 0 Sec	42 Down Time 1 Sec	43 Down Time 2 Sec	44 Down Time 3 Sec	45 Down Time 4 Sec	46 All Wheels 0 Sec	47 Fade Param 1 Sec	48 Fade Param 2 Sec	49 Fade Param 3 Sec	50 Fade Param 4 Sec	Bank 5		
51 Clear Time Delay	52 Fanned Time 2 Sec	53 Fanned Time 4 Sec	54 Fanned Time 6 Secs	55 Fanned Delay 2 Sec	56 Fanned Delay 4 Sec	57 Fanned Delay 6 Sec	58 Time Plus 1/2 Sec	59 Time Minus 1/2 Sec	60 Delay Plus 1/2 Sec	Bank 6		
61 Inten Filter	62 PanTilt Filter	63 Pan Only Filter	64 Tilt Only Filter	65 Color Mix Filter	66 Color Wheel Filter	67 Beam Filter	68 Strobe Filter	69 Rate Plus .5 sec	70 Rate Minus .5 sec	Bank 7		
71 Start Dynamic	72 Bias Rock Around	73 Bias Rock Above	74 Bias Rock Below	75 Auto Fit	76 Forward	77 Reverse	78	79 Size +30	80 Size -30	Bank 8		
81 Sine Wave	82 Triangl Wave	83 Saw Tooth Wave	84 Reverse Saw Tooth	85 Square Wave	86 OffSet Zero Degrees	87 OffSet 90 Degrees	88 OffSet 120 Degrees	89 OffSet 240 Degrees	90 Offset 360 Degrees	Bank 9		
91 Bally Hoo Dynamic	92 Circle Wave Dynamic	93 Figure8 Wave Dynamic	94 Roller Wave Dynamic	95 Tilt Wave Dynamic	96 Pan Wave Dynamic	97 Intensi Dynamic	98 Multi M-A-B Dynamic	99 Solid M-A-B Dynamic	100 Stop All Dynamic	Bank 10		
										Bank 11-20		

**Note:** Multiple instances of this window can be opened at the same time.

## Submaster Palette Area

A single palette viewing area is also available above the submaster display.

- + The <Palettes> and <System> buttons on the left switch between viewing the palette and the system overview.
- + Due to limited space, it will not switch to century or super palette mode, but it can be set to any function or bank.
- + This area is controlled in the snapshot filter as the upper button in the top-right display, and may be snapped independently from the submasters area.

My Show 08/02/12 15:15

Palettes

Control

System

Preset	BASIC								
Preset	Color	Beam	Group	Macro	Snaps	Dynamic	Stack	Effect	Eff Set
Eff Seq	Media								

1 2 3 4 5 6 7 8 9 10

IFE C B G rate 100 IFE C B G rate 100 IFE C B G rate 100 IFE C B G rate 100 IFE C B G rate 100 IFE C B G rate 100 IFE C B G rate 100 IFE C B G rate 100 IFE C B G rate 100 IFE C B G rate 100

Setup

My Show 08/02/12 15:15

Palettes

Control

System

Macro	Bank 1					Page 1	Page 2	Page 3	Page 4	Page 5
1	2	3	4	5	6	7	8	9	10	
11	12	13	14	15	16	17	18	19	20	

1 2 3 4 5 6 7 8 9 10

IFE C B G rate 100 IFE C B G rate 100 IFE C B G rate 100 IFE C B G rate 100 IFE C B G rate 100 IFE C B G rate 100 IFE C B G rate 100 IFE C B G rate 100 IFE C B G rate 100 IFE C B G rate 100

Setup

# PRESETS

---

## Overview

The Preset palette is used to store specific luminaire parameters for the purpose of building cues. Typically, a Preset will contain focus (pan/tilt) information only, but with the Vx76 consoles any desired parameter (except timing) can be stored in a Preset as determined by the filter settings. The touchscreen display is used to control the filters (refer to "Function Filter" on page 93).

Since focus is a large part of the Preset feature, no standard pre-programmed Presets are available. These will need to be stored in relation to the specific requirements of your show.

## Features

The most important feature of Presets is that they are referenced by cues. This feature provides a way of saving time during the initial programming of a show and for updating focuses or other parameters throughout all of your cues if something on stage changes. For example, a Preset may be stored as a focus reference cue in which only pan and tilt parameters are specified. These could be labeled *Center*, *Main Stage*, *Band*, etc. When you use a Preset to build a cue, the Preset information is linked directly to that cue. If a refocus is required, the appropriate Preset could be changed and all the cues built using it would automatically reflect the change.

Preset		Bank 1			Page 1	Page 2	Page 3	Page 4	Page 5
1 Home	2 Vocals	3 Guitar	4 Bass	5 Kick	6 Keys	7 Thrust	8 Audienc	9 Cyc	10
11	12	13	14	15	16	17	18	19	20

## Preset Cue Referencing

In order to prevent unintentional results, the following will apply to Presets which have referenced cues.

- + If cues are referenced in a Preset, the Preset cannot be deleted, but it can be moved or copied.
- + If cues are referenced in a Preset, the cue reference can be replaced with hard data using the syntax [-] [Preset] [#] [Enter].



## Storing, Modifying, and Recalling Presets

### From Palettes

#### Store a new preset using Presets palette:

- Step 1. Select required channels.
- Step 2. Ensure Presets are selected on at least one palette. (Refer to [page 110](#).)
- Step 3. Using manual controls, set all required parameters.
- Step 4. Filter attributes as required using touchscreen display.
- Step 5. Press and hold [Store] while pressing ⟨Preset Palette Button⟩ *or* [Store] / [Label] / ⟨Preset Palette Button⟩ ⟨xxxxxx⟩ ⟨Enter/Accept⟩.

#### Store a new preset using command-line keypad:

- Step 1. Select required channels.
- Step 2. Using manual controls, set all required parameters.
- Step 3. Filter attributes as required using touchscreen display.
- Step 4. Press [Store] [Preset] [n] [Enter] *or* [Store] [Preset] [n] [Label] ⟨xxxxxx⟩ ⟨Enter/Accept⟩ (where n is the discrete Preset number).

#### Label an existing Preset palette:

When labeling, the name can be entered on the console touchscreen keyboard *or* computer keyboard.

- Step 1. Ensure Presets are selected on at least one palette. (Refer to [page 110](#).)
- Step 2. Press and hold [Label] while pressing any Preset bank, page, or palette button.
- Step 3. Enter alpha/numeric label.

#### Add new channels to a Preset:

If a Preset is already stored, the [Store] command can add new channels to that Preset, provided those channels are selected. If the channel already has data for the Preset, that data will be overwritten with current data.

- Step 1. Select required channels.
- Step 2. Ensure Presets are selected on at least one palette. (Refer to [page 110](#).)
- Step 3. Press and hold [Store] while pressing ⟨Preset Palette Button⟩ *or* [Store] [Label] / ⟨Preset Palette Button⟩ ⟨xxxxxx⟩ ⟨Enter/Accept⟩.

#### Modify parameters using Selective Store:

The Selective Store command modifies parameter data for selected channels as determined by any filter settings. For more information, refer to "[Selective Store](#)" on page 260.

- Step 1. At touchscreen display, modify filter settings as required.
- Step 2. Select required channels.
- Step 3. Press and hold [Sel Store] while pressing ⟨Preset Palette Button⟩ *or* [Sel Store] [Preset] [n] [Enter] (where n is the discrete Preset number).

#### Update a preset:

The [Update] command does not add channels, but modifies any stored data that has been changed by manual control for channels and parameters associated with that Preset. It does not route through the filter settings. For more information, refer to "[Update](#)" on page 258.

- Step 1. Make changes by manual control.
- Step 2. Press and hold [Update] while pressing ⟨Preset Palette Button⟩ *or* [Update] [Preset] [n] [Enter] (where n is the discrete Preset number).



## Delete an entire Preset:

---

**Note:** If cues are referenced in a Preset, the Preset cannot be deleted, but it can be moved or copied.

---

- Step 1. Select all channels in that Preset.
- Step 2. [Delete] [Preset] [n] [Enter] (where n is the discrete preset number) *or* press and hold [Delete] while pressing <Preset Palette Button>. The display will now show this as an "empty" Preset.

## Delete a specific channel's Preset data:

- Step 1. Select channels you wish to remove from a Preset.
- Step 2. [Delete] [Preset] [n] [Enter] (where n is the discrete preset number) *or* press and hold [Delete] while pressing <Preset Palette Button>.

## Recall a preset using Presets palette:

- Step 1. Select required channels (only selected channels that have data stored in that preset will be affected).
- Step 2. Ensure Presets are selected on at least one palette. (Refer to [page 110](#).)
- Step 3. Press required <Preset Palette Button>.

## Recall a preset using command-line keypad:

- Step 1. Select required channels (only selected channels that have data stored in that Preset will be affected).
- Step 2. Press [Preset] [n] [Enter] (where n is the discrete Preset number).

## Recall specific preset data:

---

**Note:** For more information, refer to "[Selective Recall](#)" on page 261.

---

- Step 1. Using Function Filter, select parameters to be recalled. (Refer to "[Function Filter](#)" on page 93.)
- Step 2. Select channel(s) as required.
- Step 3. Press [Recall] [Preset] [n] [Enter] *or* [Recall] <Preset Palette Button>. All stored data will be recalled from the specified preset (n), as defined by the selections on the filters.

## Replace a Preset cue reference with hard data:

- Step 1. Select required channels.
- Step 2. At Filter, selected desired parameter(s).
- Step 3. At keypad, press [-] [Preset] [#] [Enter]. The cue reference is now replaced with hard data.
- Step 4. Re-store the cue.

## From Keypad

---

**Note:** All Presets have a discrete number which is used when accessing Presets from the keypad. Presets maintain this number, even when given another label.

---

### Store a new Preset:

- Step 1. Select required channels.
- Step 2. Using manual controls, set all required parameters.
- Step 3. Filter attributes as required using Filter Display window.
- Step 4. Press [Store] [Preset] [n] [Enter] *or* [Store] [Preset] [n] [Label] <xxxxxx> <Enter/Accept> (where n is the discrete Preset number).

### Add new channels to a Preset:

- Step 1. Select required channels.
- Step 2. Press [Store] [Preset] [n] [Enter] *or* [Store] [Preset] [n] [Label] <xxxxxx> <Enter/Accept> (where n is the discrete Preset number).

### Delete a Preset:

---

**Note:** If cues are referenced in a Preset, the Preset cannot be deleted, but it can be moved or copied.

---

- Step 1. Select all channels in that Preset palette.
- Step 2. [Delete] [Preset] [n] [Enter]. The display will now show this as an "empty" Preset.

### Recall a Preset:

- Step 1. Select required channels (only selected channels that have data stored in that Preset will be affected).
- Step 2. Press [Preset] [n] [Enter] (where n is the discrete Preset number).

## Preset Global Delete

A preset can be deleted for all channels using the command line. Use the following syntax:

+ [Delete] [Preset] # [Delete] [Enter]

A confirmation screen will appear while using this command:

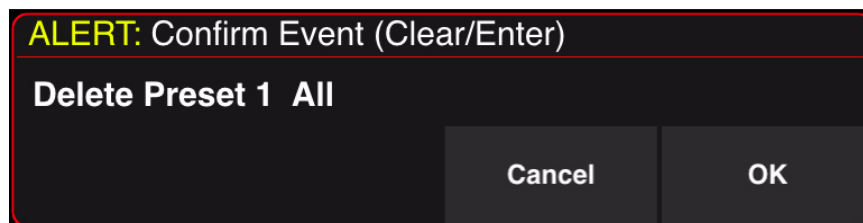

---

**Note:** If the preset is linked to a cue, an alert box will appear stating that the action is not allowed.

---

## Preset Data Window

Preset data can be viewed in the Preset Data window. The top portion of the window shows the current Presets, along with all associated labels, channels, and filters which have been stored into them. By selecting a single Preset and clicking on the Data drop-down window button, all of its parameter data can be viewed. Double-clicking on channels will recall filters and stored channels.

The Value (V) button will display the numeric value which has been stored into each parameter. The Dynamic (D) will display any associated dynamic state information. The "V" and "D" toggle buttons allow you to display one or both types of information in the window.

### Open Preset Data window:

- + At Data menu, select Preset Data.

Data	Special	Patch	W
Cue Data			
Cue Data			
Preset Data			
Color Palette Data			
Beam Palette Data			
Dynamics Palette Data			
Effects			
Sets			
Sequences			
Macros			
Snapshots			
Timecode Scripts			
Toggle Data Editing			

Associated Filters

Associated Channels

Preset Number

Label

Data Drop-Down Window - Displays data for selected Preset.

Value - Displays value that luminaire is reporting for the parameters when selected.

Dynamic - Displays dynamic state information when selected.

Opens Parameter Columns window \* which is used to choose which columns appear in window.

#	Preset	Filter	Channels
1	Home		1-9, 11-16, 21-26, 41-46, 51-56, 61-66, 71-73, 81-84, 91-92,
2	DS Center		1-9, 11-16, 21-26, 41-46, 51-56, 61-66, 71-73
3	3 Down ...		41-46, 51-56, 61-66
4	4 Cross ...		41-46, 51-56, 61-66
5	5		
6	6		
7	7		
8	8		
9	9		
10	10		
11	11		
12	12		
13	13		
14	14		
15	15		
16	16		
17	17		

Chan	Inten	Pan	Tilt	Amber	Blue	Magenta	Beam
41		33511	35427	...	...	...	
42		35247	35497	...	...	...	
43		33573	34867	...	...	...	
44		32767	35567	...	...	...	
45		31465	35007	...	...	...	

\* Refer to "Parameter Columns Window" on page 82.



# COLORS

## Overview

The Color palette provides a means for storing and recalling up to 300 colors. These can be used for building cues and effects.

Colors are stored by luminaire type. This means that for any one luminaire type, only one Color setting can be stored in a single Color palette. For example, a palette can store different settings for Bad Boy® and VL6C+® luminaires, but multiple settings cannot be stored for multiple Bad Boy luminaires. During a store operation, the color parameters stored will be drawn from either the lowest *active* luminaire or lowest *selected* luminaire as determined by the console's default setting (refer to "**System-Wide Palette Store Options**" on page 105).

Color	Bank 1				Page 1	Page 2	Page 3	Page 4	Page 5
1 N/C	2 Magenta	3 Amber	4 Blue	5 Congo	6 Yellow	7 CTO	8 Green	9 Red	10
11	12	13	14	15	16	17	18	19	20

### Guidelines:

- + Colors are not linked to Presets or cues. This means that if a certain Color palette was used when creating a cue and a new color is stored into that palette, then this will not affect the color stored in the Preset or cue.
- + Parameters stored into a Color palette are filtered only when the console's default setting is configured to do so (refer to "**System-Wide Palette Store Options**" on page 105 and "**Function Filter**" on page 93).

### Example Function Filter Setup

The screenshot shows the 'Function Filter' interface. The 'Wheel 2' filter is selected and highlighted with a red box. The 'Color' filter is also highlighted. The 'Func Filter To Cue' and 'Filter All' options are visible on the right side of the grid. The bottom of the screen shows the console's status bar with various indicators like 'Filter', 'Timing', 'Snapshot', 'Timecode', 'Patch Console State', 'Part', 'Macro Rec', 'Live', 'Stack', 'Cue', 'Effect', and 'Board'.



## Storing and Recalling Colors

---

**Note:** Beams and Colors are global settings by luminaire type. During a store operation, the parameters that are stored will be drawn from either the lowest *active* luminaire or lowest *selected* luminaire as determined by the console's default setting (refer to "[System-Wide Palette Store Options](#)" on page 105).

---

### From Palettes

#### Store a new color using Colors palette:

- Step 1. Ensure color you wish to store is displayed in lowest *active* luminaire channel (for each luminaire type), if the default "lowest active channel" has not been changed (refer to "[Settings Window](#)" on page 306).
- Step 2. Ensure Colors are selected on at least one palette. (Refer to [page 110](#).)
- Step 3. Select required bank and select page.
- Step 4. Press and hold [Store] while pressing <Color Palette Button>.

#### Store a new color using command-line keypad:

- Step 1. Ensure color you wish to store is displayed in lowest *active* luminaire channel (for each luminaire type), if the default "lowest active channel" has not been changed (refer to "[Settings Window](#)" on page 306).
- Step 2. Press [Store] [Color] [n] [Enter] (where n is the discrete Color number).

#### Label an existing color, page, or bank:

When labeling, the name can be entered on the console touchscreen keyboard *or* computer keyboard.

- Step 1. Ensure Colors are selected on at least one palette. (Refer to [page 110](#).)
- Step 2. Press and hold [Label] while pressing any Color bank, page, or palette button.
- Step 3. Enter alpha/numeric label.

#### Recall a color using Colors palette:

- Step 1. Select required channels.
- Step 2. Ensure Colors are selected on at least one palette. (Refer to [page 110](#).)
- Step 3. Press required <Color Palette Button>.

#### Recall a color using command-line keypad:

- Step 1. Select required channels.
- Step 2. Press [Color] [n] [Enter] (where n is the discrete Color number).

---

**Note:** Channels that are selected during a color recall that have no value for that color will remain in their current state.

---

### From Keypad

#### Store a new Color:

- Step 1. Select required channels.
- Step 2. Using manual controls, set all required parameters.
- Step 3. Press [Store] [Color] [n] [Enter] *or* [Store] [Color] [n] [Label] [Enter] <xxxxxx> <Enter/Accept> (where n is the discrete Color number).

#### Delete a Color:

- + [Delete] [Color] [n] [Enter]. The display will now show this as an "empty" Color.

**Note:** This action will delete color information for all types stored.

### Recall a Color:

- Step 1. Select required channels (only selected channels that have data stored in that Color will be affected).
- Step 2. Press [Color] [n] [Enter] (where n is the discrete Color number).

### Color Palette Data Window

Color data can be viewed in the Color Palette Data window.

The top portion of the window shows current stored Colors, along with all applicable luminaires. By selecting a single color and clicking on the Data drop-down window button, all of its numeric values can be viewed.

#### Open Color Palette Data window:

- + At **Data** menu, select **Color Palette Data**.

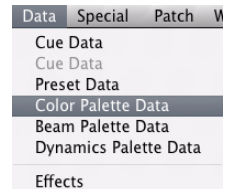

Luminaire Name Box - Select to initiate the copy function (see below)

Color Number

Data Drop-Down Window - Displays data for selected Color.

Value - Displays value that luminaire is reporting for the parameters when selected.

Dynamic - Displays dynamic state information when selected

#	Label	VL5	Mac250K	iCove	MAC2k...	AutoYo...	VL58m4	MAC2kP	VL250...
1	1 Open White			•	•	•	•	•	
2	2 Sepia			•	•	•	•	•	
3	3 Black			•	•		•	•	
4	4 UV			•	•		•	•	
5	5 Red			•	•		•	•	
6	6 Orange			•	•		•	•	
7	7 Yellow			•	•		•	•	
8	8 Magenta			•	•		•	•	
9	9 Purple				•		•	•	
10	10 Pink				•		•	•	
11	11 Cyan				•		•	•	
12	12 Dk Blue				•		•	•	
13	13 Warm				•		•	•	
14	14 Steel 1				•		•	•	
15	15 Steel 2				•		•	•	
16	16 Green			•	•		•	•	
17	17 Lav 1				•		•	•	
18	18 Lav 2				•		•	•	
19	19 Mauve				•		•	•	

Device	Blue	Amber	Magenta	Wheel	Color W	Color 6	Color 7
MAC2kWD	0	0	0	255	...		
VL58m4	0	81	71				
MAC2kP	0	0	0	255			

It is possible to copy data from luminaire type to luminaire type using the Color Palette Data window. During the copy process, data will be appropriately mapped to the new luminaire type. Copy and Paste of palette data allows either Paste Merge or Paste All actions.

- + **Merge** copies data only where existing data does not exist in the destination and will not over-write existing data.
- + **Replace All** clears out all of the existing destination data and replaces it with the source data.

### To perform a Paste Merge or Paste All action:

- Step 1. At top of column, select name box of source luminaire (for example, VL5).
- Step 2. At Mac keyboard, press WIN + C (to copy).
- Step 3. At top of column, selected name box of destination luminaire (for example, VL5Arc).
- Step 4. Press WIN + V (to paste).
- Step 5. At confirmation dialogue, press **Paste (Merge)** or **Paste (Replace All)**.

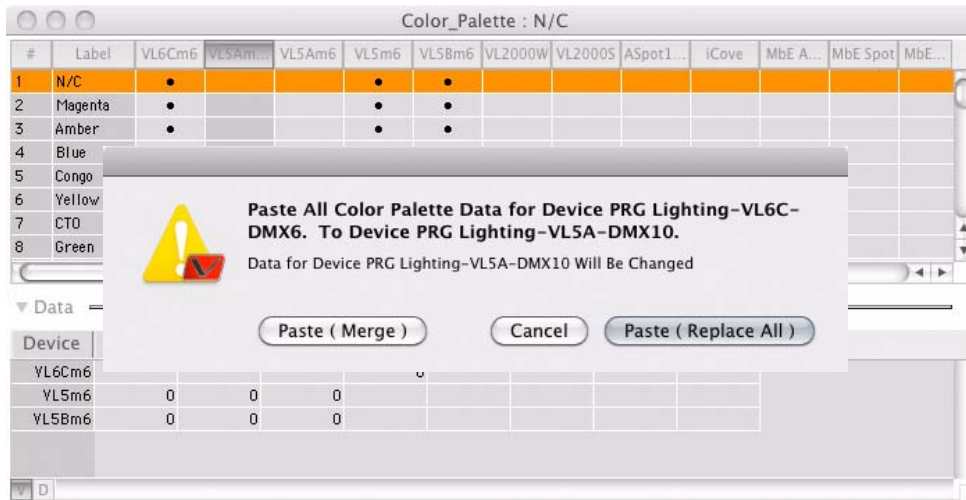

# BEAMS

## Overview

The Beam palette provides a means for storing and recalling up to 200 beam states. These can be used for building cues and effects. These programmable Beams can include parameters such as beam (zoom, shutter, framing), edge (frost, effect, prism), and gobo (static, rotating, index, effects, effects rotation) as determined by the beam edge and gobo filter settings (refer to "Function Filter" on page 93).

Beams are stored by luminaire type. This means that for any one luminaire type, only one Beam setting can be stored in a single Beam palette. For example, a palette can store different settings for Bad Boy® and VL6C+® luminaires, but multiple settings cannot be stored for multiple Bad Boy luminaires. During a store operation, the beam parameters stored will be drawn from either the lowest *active* luminaire or lowest *selected* luminaire as determined by the console's default setting (refer to "System-Wide Palette Store Options" on page 105).

Beam	Bank 1				Fixed	Page 2	Page 3	Page 4	Page 5
1 Open	2 Pebbles	3 Breakup	4 Night Sky	5 Leaves	6 Vert Bar	7 Tribal	8 Blocks	9 Sqiggle	10 Card board
11 Horzon Lines	12 Spin	13 Fast Spin	14	15	16	17	18	19	20

### Guidelines:

- + Beams are not linked to Presets or cues. This means that if a certain Beam was used when creating a Preset or cue and a new Beam is stored into that palette, then this will not affect the Beam stored in the Preset or cue.
- + Timing values cannot be stored in Beams.
- + Parameters stored into a Beam palette are always determined by the filters (refer to and "Function Filter" on page 93).

### Example Function Filter Setup

The screenshot displays the 'Function Filter' setup screen. At the top, there are navigation icons (X and +) and a 'Cue List' section. The main area is a grid of filter settings. A red box highlights the 'Beam2' column, which includes settings like Framing, Strobe, Zoom, Beam, and BEAM. The interface also shows a 'Plan View' section with 'Page 1' and 'All' buttons, and a 'Utilities' section with 'Filter All' and 'Filter Clear' buttons. At the bottom, there are various status indicators and controls, including 'Filter', 'Timing', 'Snapshot', 'Timecode', 'Patch Console State', 'Part', 'Macro Rec', 'Live', 'Stack', 'Cue', 'Effect', and 'Board'.



## Storing, Modifying, and Recalling Beams

---

**Note:** Beams and Colors are global settings by luminaire type. During a store operation, the parameters that are stored will be drawn from either the lowest *active* luminaire or lowest *selected* luminaire as determined by the console's default setting (refer to "[System-Wide Palette Store Options](#)" on page 105).

---

### From Palettes

#### Store a new Beam using Beams palette:

- Step 1. Select required channels.
- Step 2. Ensure Beams are selected on at least one palette. (Refer to [page 110](#).)
- Step 3. Using manual controls, set all required parameters.
- Step 4. Using Function Filter, filter parameters as required. (Refer to "[Function Filter](#)" on page 93.)
- Step 5. Press and hold [Store] while pressing <Beam Palette Button> *or* [Store] [Label] / <Beam Palette Button> <xxxxxx> <Enter/Accept>.

---

**Note:** Parameters stored into a Beam palette are always determined by the filters (refer to "[Function Filter](#)" on page 93).

---

#### Store a new Beam using command-line keypad:

- Step 1. Select required channels.
- Step 2. Using manual controls, set all required parameters.
- Step 3. Filter attributes as required using touchscreen display.
- Step 4. Press [Store] [Beam] [n] [Enter] *or* [Store] [Beam] [n] [Label] [Enter] <xxxxxx> <Enter/Accept> (where n is the discrete Beam number).

#### Label an existing Beam, page, or bank:

When labeling, the name can be entered on the console touchscreen keyboard *or* computer keyboard.

- Step 1. Ensure Beams are selected on at least one palette. (Refer to [page 110](#).)
- Step 2. Press and hold [Label] while pressing any Beam bank, page, or palette button.
- Step 3. Enter alpha/numeric label.

#### Add a new luminaire type to a Beam:

If you are modifying a Beam by storing a new type of luminaire(s), then the new data will be added to the existing data.

- Step 1. Select required channel(s). (The channel should contain at least one different luminaire type than currently stored in the Beam.)
- Step 2. Ensure Beams are selected on at least one palette. (Refer to [page 110](#).)
- Step 3. Using manual controls, set all required parameters.
- Step 4. Using Function Filter, filter parameters as required. (Refer to "[Function Filter](#)" on page 93.)
- Step 5. Press and hold [Store] while pressing <Beam Palette Button> *or* [Store] [Label] / <Beam Palette Button> <xxxxxx> <Enter/Accept>.

### Modify Beam data for an existing luminaire type:

If you are modifying a Beam with data from the same type of luminaire, then the data will be replaced.

- Step 1. Select required channel(s). (The channel should contain the same luminaire type as currently stored in the Beam.)
- Step 2. Ensure Beams are selected on at least one palette. (Refer to [page 110](#).)
- Step 3. Using manual controls, set all required parameters.
- Step 4. Using Function Filter, filter parameters as required. (Refer to "Function Filter" on page 93.)
- Step 5. Press and hold [Store] while pressing <Beam Palette Button> or [Store] [Label] / <Beam Palette Button> <xxxxxx> <Enter/Accept>.

### Delete a Beam:

- + [Delete] [Beam] [n] [Enter] or press and hold [Delete] while pressing <Beam Palette Button>. The display will now show this as an "empty" Beam palette.

---

**Note:** This action will delete beam data for all types included in that particular palette.

Since Beam palettes store data according to luminaire types, if a Beam is recalled which has no data for that luminaire type, then the channel will remain in its previous state. When recalled, Beams are not routed through the filters.

---

### Recall a Beam using Beams palette:

- Step 1. Select required channels (only selected channels of types that have data stored in that beam state will be affected).
- Step 2. Ensure Beams are selected on at least one palette. (Refer to [page 110](#).)
- Step 3. Press required <Beam Palette Button>.

### Recall a Beam using command-line keypad:

- Step 1. Select required channels (only selected channels of types that have data stored in that Beam will be affected).
- Step 2. Press [Beam] [n] [Enter] (where n is the discrete Beam number).

### From Keypad

#### Store a new Beam:

- Step 1. Select required channels.
- Step 2. Using manual controls, set all required parameters.
- Step 3. Filter attributes as required using Filter Display window.
- Step 4. Press [Store] [Beam] [n] [Enter] or [Store] [Beam] [n] [Label] [Enter] <xxxxxx> <Enter/Accept> (where n is the discrete Beam number).

#### Add new types to a Beam:

- Step 1. Select required channels.
- Step 2. Using manual controls, set all required parameters.
- Step 3. Filter attributes as required using Filter Display window.
- Step 4. Press [Store] [Beam] [n] [Enter] or [Store] [Beam] [n] [Label] [Enter] <xxxxxx> <Enter/Accept> (where n is the discrete Beam number).

#### Delete a Beam:

- Step 1. [Delete] [Beam] [n] [Enter]. The display will now show this as an "empty" Beam.

**Recall a Beam:**

- Step 1. Select required channels (only selected channels that have data stored in that Beam will be affected).
- Step 2. Press [Beam] [n] [Enter] (where n is the discrete Beam number).

**Beam Palette Data Window**

Beam data can be viewed in the Beam Palette Data window.

The top portion of the window shows the current Beams, along with all associated filters which have been stored into its palette. By selecting a single Beam and clicking on the Data drop-down window button, all of its parameter data can be viewed.

The Value (V) button will display the numeric value which has been stored into each parameter. The Dynamic (D) will display any associated dynamic state information. The V and D toggle buttons allow you to display one or both types of information in the window.

**Open Beam Palette Data window:**

- + At Data menu, palette Beam Palette Data.

Data	Special	Patch	W
Cue Data			
Cue Data			
Preset Data			
Color Palette Data			
Beam Palette Data			
Dynamics Palette Data			
Effects			
Sets			
Sequences			
Macros			
Snapshots			
Timecode Scripts			
Toggle Data Editing			
Revert to Defaults			

Annotations:

- Label
- Beam Number
- Associated Filters
- Luminaire Name Box - Select to initiate the copy function (see next page)
- Applicable Luminaire Types
- Data Drop-Down Window - Displays data for selected Beam.
- Value - Displays value that luminaire is reporting for the parameters when selected.
- Dynamic - Displays dynamic state information when selected.
- Opens Parameter Columns window \* which is used to choose which columns appear in window.

\* Refer to "Parameter Columns Window" on page 82.



It is possible to copy data from luminaire type to luminaire type using the Beam Palette Data window. During the copy process, data will be appropriately mapped to the new luminaire type. Copy and Paste of palette data allows either Paste Merge or Paste All actions.

- + **Merge** copies data only where existing data does not exist in the destination and will not over-write existing data.
- + **Replace All** clears out all of the existing destination data and replaces it with the source data.

**To perform a Paste Merge or Paste All action:**

- Step 1. At top of column, select name box of source luminaire (for example, VL5).
- Step 2. At Mac keyboard, press WIN + C (to copy).
- Step 3. At top of column, selected name box of destination luminaire (for example, VL5Arc).
- Step 4. Press WIN + P (to paste).
- Step 5. At confirmation dialogue, press **Paste (Merge)** or **Paste (Replace All)**.



# GROUPS

## Overview

To automate channel selection, groups of channels may be stored into the Group palette. Groups can also be created and recalled from the command-line keypad.

For example, you could store all VL2000™ spot luminaires as one group and all VL2000™ wash luminaires as another group. These groups can be labeled in the Group palette as "VL2K Spot" and "VL2K Wash."

Group		Main			Movers	LED's	MboxEx	CONV	Page 5
1 VL6C	2 VL5A	3 VL5	4 VL2K Spot	5 VL2K Wash	6	7	8	9	10
11	12	13 VL5 Odd	14 VL5 Even	15	16	17	18	19	20

### Guidelines:

- + When a Group is stored, channel selection *order* is retained. This is known as an "Ordered Group." This information may be used for stepping through Next/Last sequences or deleted as required. Refer to "[Ordered Groups](#)" on page 131 for more information.
- + When an existing Group is updated or re-stored, the new information replaces the old information. It does not add to the existing group information.
- + Advanced group settings can be configured using the Group super palette. Refer to "[Group Super Palette \(Advanced Operation\)](#)" on page 132 for more information.

## Storing, Modifying, and Recalling Groups (Basic Operation)

During a basic store operation, all selected channels will be collected into the group.

### From Palettes

**Tip** ⇨ For all storable items, the default label (number) will move from the middle to the top line of the palette button when something has been stored in it.

#### Store a group:

Step 1. Select channels to be stored in group (refer to "[Selecting Channels](#)" on page 50).

Step 2. Access required Bank and Page.

Step 3. Press and hold [Store] while pressing ⟨Group Palette Button⟩ *or* [Store] [Label] / ⟨Group Palette Button⟩ ⟨xxxxxx⟩ ⟨Enter/Accept⟩

#### Label a group:

When labeling, the name can be entered on the console touchscreen keyboard *or* computer keyboard.

Step 1. Ensure Groups are selected on at least one palette. (Refer to [page 110](#).)

Step 2. Press and hold [Label] while pressing any Group bank, page, or palette button.

Step 3. Enter alpha/numeric label.

#### Recall a group:

Step 1. Access required Bank and Page.

Step 2. Press required ⟨Group Palette Button⟩.



### Recall two or more groups:

- Step 1. Access required Bank and Page of first group.
- Step 2. Press required <Group Palette Button>.
- Step 3. Access required Bank and Page of second group.
- Step 4. Press required <Group Palette Button> of second group. Hold down [Page Button] to pile-on selections.
- Step 5. Repeat Steps 3 and 4 as required.

### Modify a group:

Modifications to existing groups can be done in the same manner as storing the original group as given above.

### From Keypad

#### Store a Group:

- Step 1. Select channels to be stored in group (refer to "Selecting Channels" on page 50).
- Step 2. Press [Store] [Group] [n] [Enter].

#### Modify a Group:

Modifications to existing Groups can be done in the same manner as storing the original Group given above.

#### Recall a Group:

The following are samples of possible command-line entries to recall a group.

- + [Group] [n] [Enter] - selects all channels in Group n.
- + [Group] [n] [+] [m] [Enter] - selects all channels in Group n plus Channel m.
- + [Group] [n] [+] [Group] [m] [Enter] - selects all channels in Group n and Group m.

### Ordered Groups

Channel selection *order* is retained when storing a Group. When recalling a Group, the following will apply:

- + Next/Last and Fan will follow original selection order.
- + [Store] [Set] [n] [Enter] - stores a group into an Effects Set. The selection order will become the Parts (of the Set).
- + [Group] [Set] [n] [Enter] - selects all channels in an Effects Set. The Parts of the set become the order. This can then be stored as an Ordered Group.

#### Example:

If channels 1, 3, 5, 2, 4, and 6 are selected in this order and then stored as an Ordered Group, this same order will be recalled when pressing the [Next] or [Last] buttons.

To clear the order from a Group, press the [Invert] button twice. (It will return to numeric channel order 1, 2, 3, 4, 5, and so on.)

---

**Note:** The sequential ordering of channels in the group can be changed using the Arrangement tab available on the Group super palette. Refer to "Arrangement Tab" on page 135.

---

## Group Super Palette (Advanced Operation)

### Overview

The Group super palette offers advanced options for the arrangement and construction of groups.

The super palette can be accessed by pressing the super palette icon at the right of any visible Group palette:

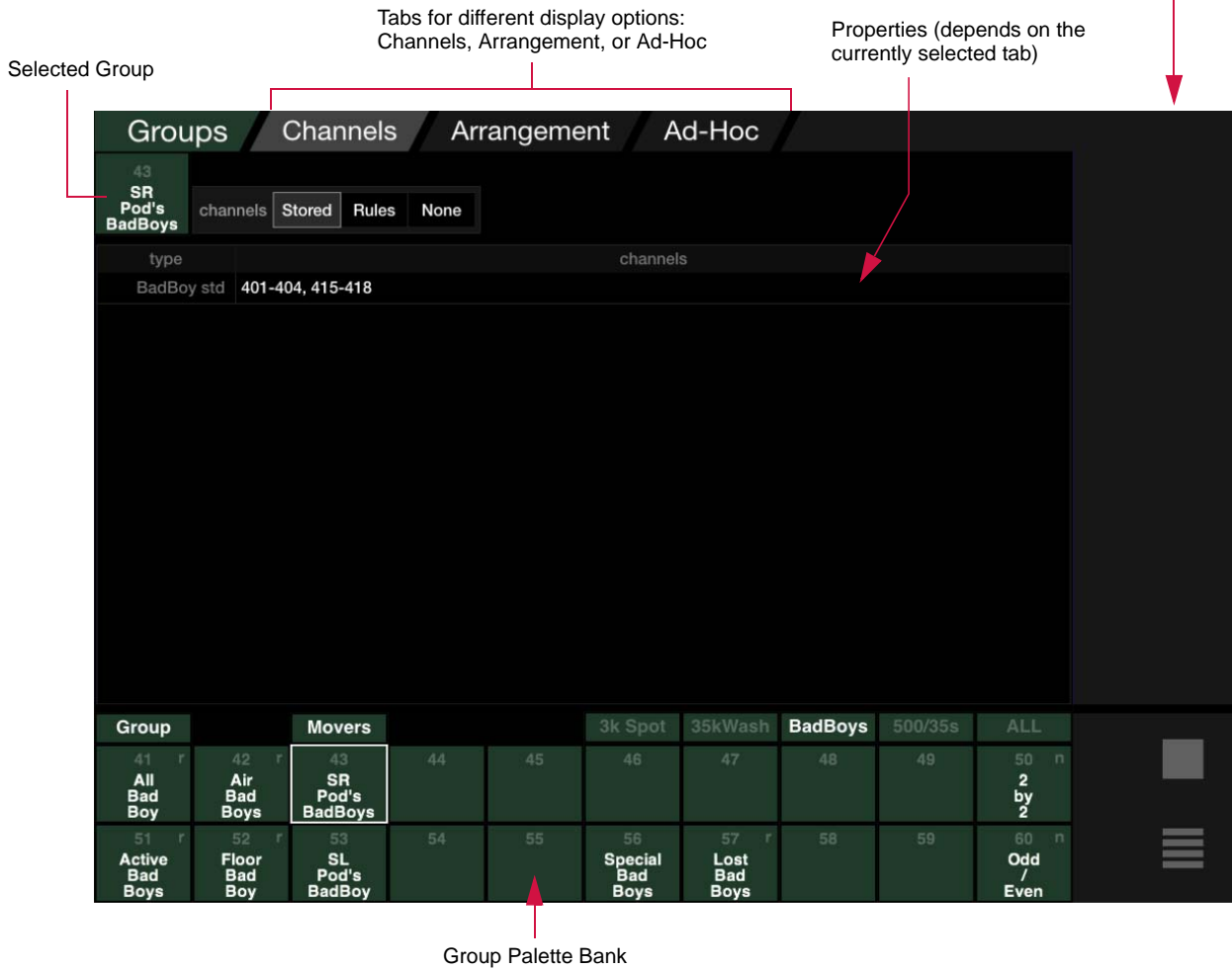

When the super palette is opened, it will default to the current settings for the selected group. A different group can be selected using the palette banks at the bottom of the screen.

The super palette offers three tabbed views: **Channels**, **Arrangement**, and **Ad-Hoc**. (Each of these tabs will be discussed in the following pages.)

A Group is made up of two components: **Channels** and **Arrangement**. For each of these components, several options are available. The following diagram illustrates the basic components and settings of a group:

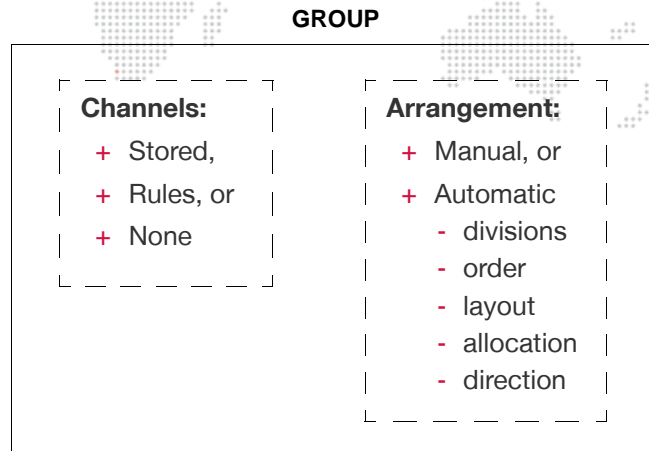

The **Channels** component specifies how - or if - channels get collected into the group. Channels can be explicitly loaded (when set to Stored) or loaded by a set of one or more rules (when set to Rules). The Rules feature is similar to a "smart playlist." If set to None, then no channels are actually stored in the group. This allows an "arrangement" to be pre-defined and then applied to a selected group of channels at a later time.

To indicate whether a group has rule-based channels or no channels (none), an indicator will appear in the group's palette button.

- + Groups with rule-based channels will have a lowercase "r" in the top-right corner of their palette button.
- + Groups with no channels will have a lowercase "n" in the top-right corner of their palette button.

3k Spot	35kWash	BadBoys	500/35s	ALL
45	46	47	48	49
55	56 Special Bad Boys	57 Lost Bad Boys	58	59
60	Odd / Even	n	r	n

Indicator:  
r = rules

Indicator:  
n = none

The **Arrangement** component specifies how the channels are arranged in the group. The arrangement can be Automatic or Manual (unless the Channels are rule-based, in which case Manual will be disabled). Manual allows the channels to be stored into individual divisions (similar to programming Effect Sets). If Automatic is chosen, then the arrangement will follow the settings for Order, Layout, Allocation, and Direction, all of which have several options available in their respective pop-up menus.

Pressing the console's [Next] and [Last] buttons will cycle through the group according to the arrangement properties.

Pressing the [Next] and [Last] buttons together reselects the last selection.

**Important Note: Saving Changes**

Changes made in the Group super palette are temporary until stored into the group. The Group label/number in the top-left of the window will change to yellow to show that there are unsaved changes. To commit the changes, press and hold [Store] while pressing either the group's palette button or the yellow labeled area as shown at the right.

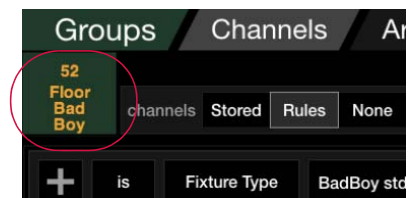

## Channels Tab

The Channels tab shows the current channels contained in the selected group. A "channel selector" at the top of the window determines how - or if - channels get collected into the group. The channel selector options are as follows:

- + **Stored** - all selected channels will be collected into the group.

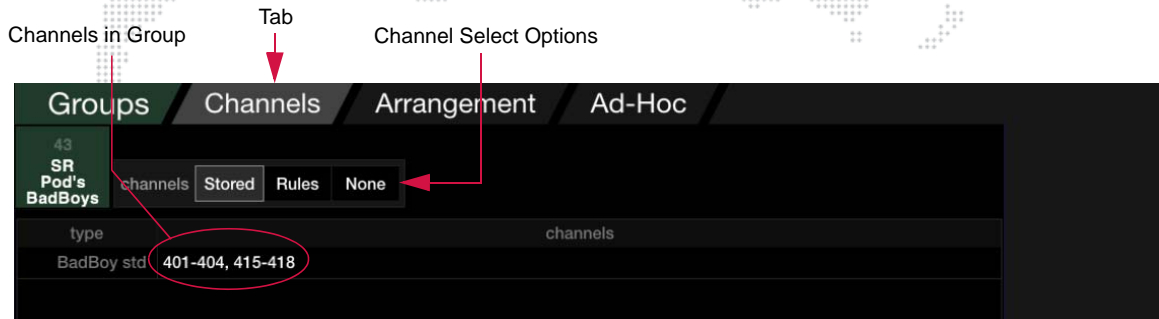

- + **Rules** - a set of one or more rules determines which channels are loaded into the group. Rules can be added using the (New Rule) button or deleted using the (X) button. Rules can be additive (+) or subtractive (-), "is" or "is not," and can be applied to specific channels as determined by the Fixture Type selection. Additional conditions can be added to a rule using the (&) button.

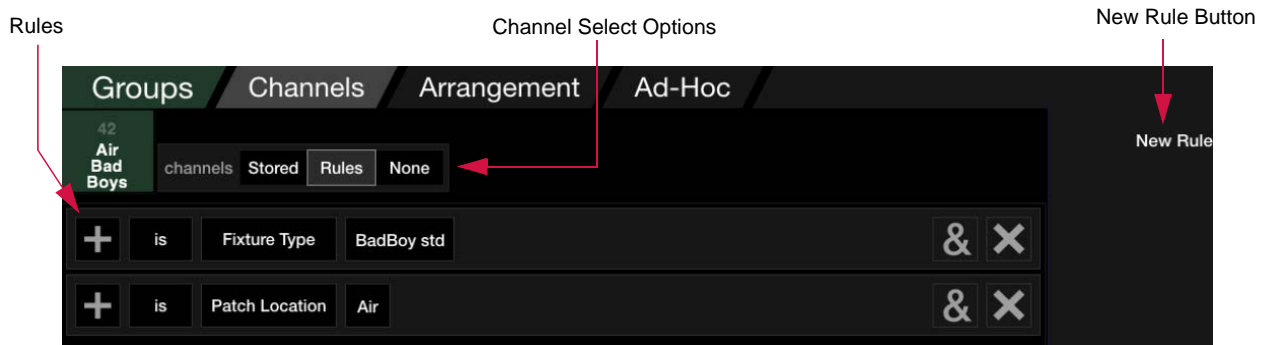

- + **None** - no channels are collected into the group. However, the group can still contain arrangement information to modify a current channel selection. (This allows an "arrangement" to be pre-defined and then applied to a selected group of channels at a later time. See "[Arrangement](#)" on the following page.)

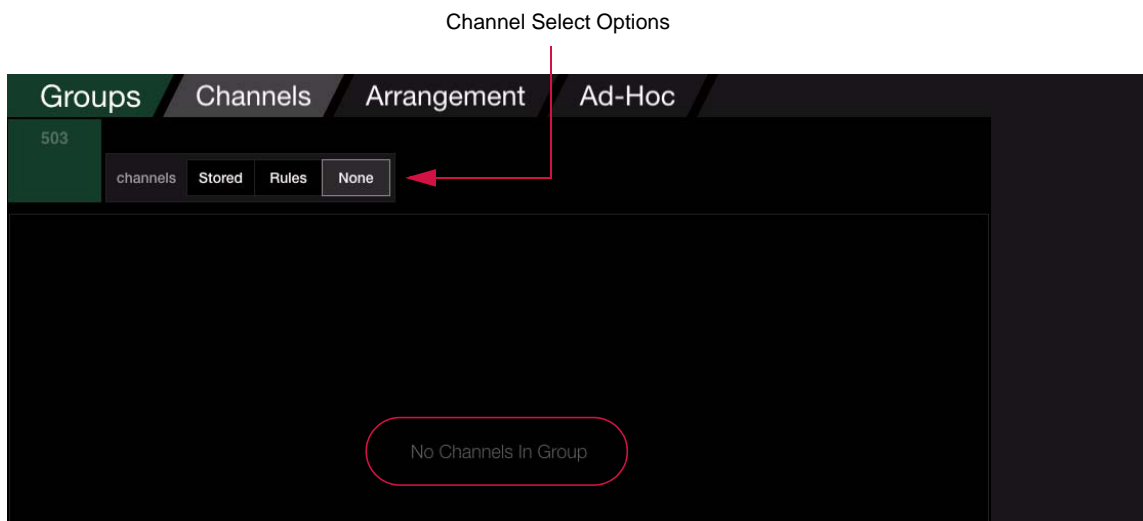

## Arrangement Tab

The Arrangement tab defines the components of a group. These are arranged as an ordered parts list, broken into divisions (if multiple divisions have been set). The top of the window provides controls to change how channels get arranged or distributed within the group. The arrangement can be applied automatically (according to the settings) or programmed manually. (Programming the Arrangement manually is similar to programming Effect Sets.)



- + **Automatic/Manual** - **Automatic** specifies that the arrangement will follow the settings for Order, Layout, Allocation, and Direction. **Manual** allows the channels to be manually stored into individual divisions.
  - Note that channels cannot be stored to an automatically arranged division. If the channels are "None," the tab switches to the Automatic arrangement.
  - Manual will be disabled if channels are rule-based since the group's channels will vary depending on the rules.

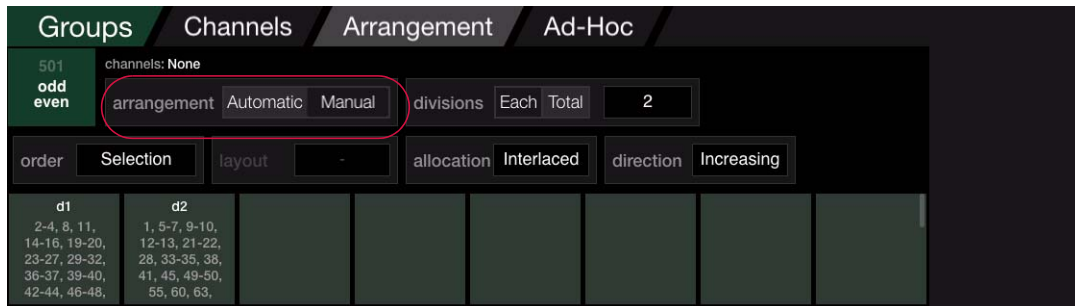

- + **Divisions** - specifies the number of fixtures to place in each division (when set to Each) or a total number of divisions in which to place all of the fixtures (when set to Total.). The number of divisions can be set from 1 to 2000. For example, you could have two (2) divisions: one for ODD channels and one for EVEN channels.

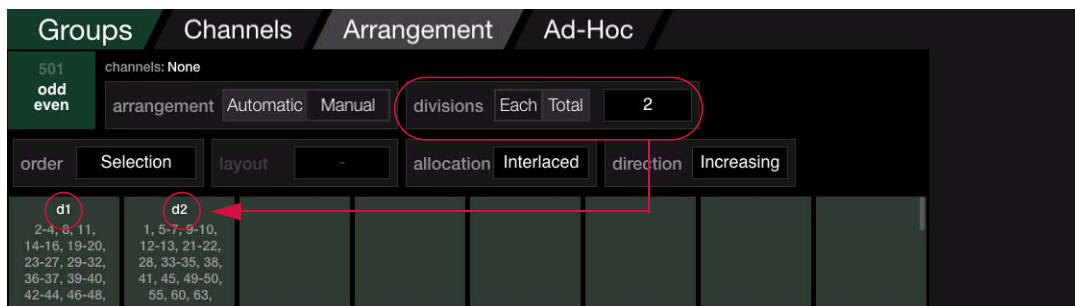

- + **Order** - the sequential ordering of channels in the group. Options for channel order include Selection (default), Channel Number, X Position, Y Position, X/Y Position, or Rule Group.

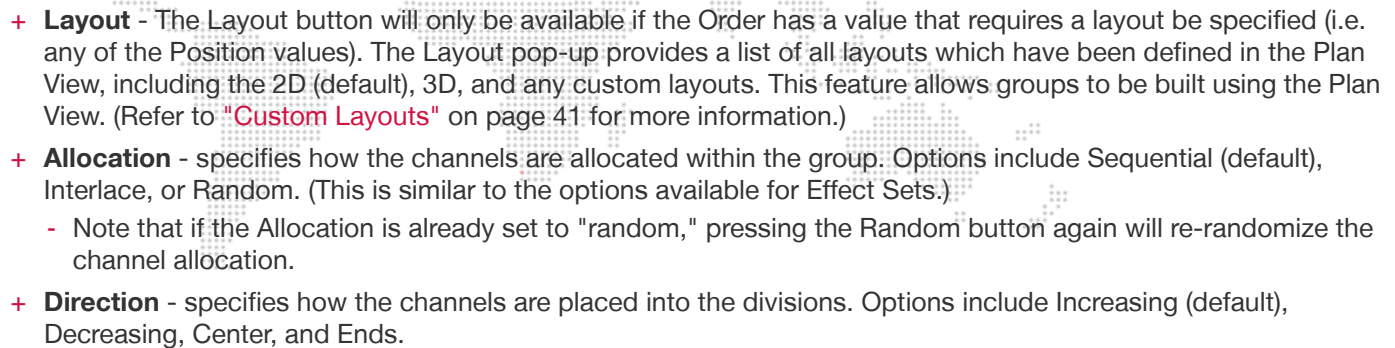
- 
- + **Layout** - The Layout button will only be available if the Order has a value that requires a layout be specified (i.e. any of the Position values). The Layout pop-up provides a list of all layouts which have been defined in the Plan View, including the 2D (default), 3D, and any custom layouts. This feature allows groups to be built using the Plan View. (Refer to "**Custom Layouts**" on page 41 for more information.)
  - + **Allocation** - specifies how the channels are allocated within the group. Options include Sequential (default), Interlace, or Random. (This is similar to the options available for Effect Sets.)
    - Note that if the Allocation is already set to "random," pressing the Random button again will re-randomize the channel allocation.
  - + **Direction** - specifies how the channels are placed into the divisions. Options include Increasing (default), Decreasing, Center, and Ends.

## Ad-Hoc Tab

The Ad-Hoc tab allows Ad-Hoc groups to be visualized and changed. Refer to the next section for instructions on using Ad-Hoc groups.

## Ad-Hoc Groups

Ad Hoc groups are a way of selecting channels "on-the-fly" which are not already pre-stored as a group. The Ad Hoc feature accomplishes this task by allowing you to select channels based on information such as "all channels in a specific preset" or "all channels in a specific color."

Ad Hoc groups can be created using the palettes, command-line keypad, specialty buttons, or the submasters.

### From Keypad

- + [Group] [Preset] [n] [Enter] - selects all active channels in Preset n (where n is the discrete preset number).
- + [Group] [Color] [n] [Enter] - selects all active channels in Color n (where n is the discrete color number).
- + [Group] [Cue] [n] [Enter] - selects all active channels in Cue n. (This does not affect the current position of those channels.)
- + [Group] [At] [n] - selects all active channels with intensity value of n.
- + [Recall] [Group] [Cue] [n] [Enter] - selects all channels that have data for Cue n.

### From Palettes

- + Press and hold [Group] while pressing ⟨Preset Palette Button⟩ - selects all active channels in Preset n (where n is the discrete preset number).
- + Press and hold [Group] while pressing ⟨Beam Palette Button⟩ - selects all active channels in Beam n (where n is the discrete beam number).

### From Submasters

- + Press and hold [Group] while touching a specific submaster on the touchscreen - selects all channels in the submaster's active cue.

### From Effect Super Palette

- + Using [Group] with a set part will select channels in the part as an Ad Hoc Group.
- + Using [Group] with any effect in the Effect palette will select ALL channels in the effects set as an Ad Hoc Group.



## From Group Super Palette

The Ad-Hoc tab provides a method for making "live" selections based on current status.

The window provides a succession of accordion menus which can be used to define the conditions for selecting channels. The accordion menus list all channels according to various criteria such as Fixture Type, Intensity State, Color, Beam, Preset, etc. Select a criteria in each successive column to narrow down and refine the selection. Select options to create an ad-hoc group.

The screenshot shows the Ad-Hoc selection interface. It features a grid of selection criteria and a list of selected channels. Annotations include:

- Active Channels:** Points to the 'Fixture Type' column.
- Tab:** Points to the 'Ad-Hoc' tab.
- Refresh Button:** Points to the 'Refresh' button.

Fixture Type	Intensity State	Preset	Color
All 414	All 18	All 10	Beam
VL3000S 80	Active 10	4 Center 10	Group
Convl 66	Full 10		Dynamic
VL3500W 64	Marked 8		
VL500D ext 58			
CBlast 53			
Atomic 3K-4Ch-1Colr 48			
BadBoy std 18			
VL3500S 15			
CromaQ 10			

Selected: (10) 401-402, 405, 408-411, 414, 417-418

Group	Bank 10	Page 1	Page 2	Page 3	Page 4	Page 5
981	982	983	984	985	986	987
991	992	993	994	995	996	997
					998	999
						1000

Annotations at the bottom:

- Total Selected Channels (#):** Points to the 'Group' column.
- Selected Channels:** Points to the 'Bank 10' column.

- + **Refresh** - If any changes are made to the currently active channels, it will be necessary to press <Refresh> to update the window. The window does not automatically update when changes are made to the cue selection.
- + **Clear Selection** - Press <Clear Selection> to clear all current selections.

## OTHER PALETTE TYPES

### Dynamics, Effects, Snapshots, Macros, and Stacks

Dynamics, Effects, Snapshots, Macros, and Cue Stacks can also be stored and recalled using the palettes. Instructions for storing and recalling these types of events are covered elsewhere in this manual as follows:

- + "Dynamics" chapter on page 149.
- + "Effects" chapter on page 169.
- + "Snapshots" on page 228.
- + "Macros" on page 233.
- + "Cue Stacks" on page 273.



### Media

Patched media servers can be accessed in the Media palette. Refer to:

- + "Controlling Media Servers" on page 210.

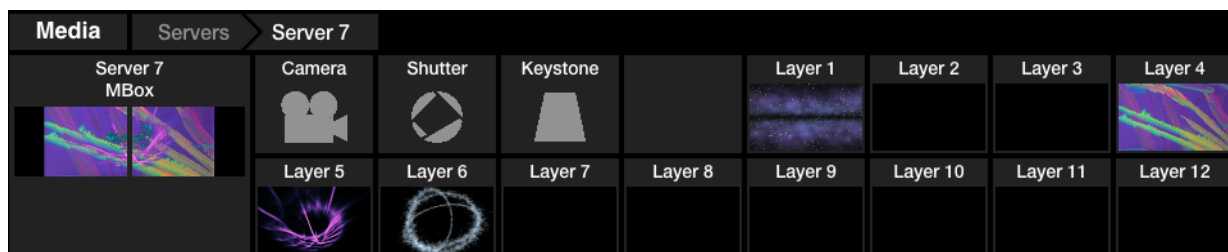



## 6.

# BASIC CUES

This chapter provides an overview of cue concepts and instructions for storing a basic cue and playing it back. Once you are familiar with these basic operations, the ["Advanced Cue Features" chapter on page 249](#) will allow you to fully utilize all of the console's cue capabilities.

- + CREATING CUES
- + PLAYING BACK CUES

## CREATING CUES

---

### What Is a Cue?

A cue stores a predefined combination of luminaire parameters such as focus, color, beam, timing, etc. which will be recalled when the cue is played back in a submaster. By playing back a series of cues, a show can be created.

Cues are stored with numbers which enable random access for modification or playback at any time. The console can store up to 10,000 cues, numbered from .01 to 9999.99. Cues can also be given alpha-numeric labels for identification.

The cue store process is basically a "what you see is what you get" operation based on the intensity state of the luminaire. In other words, the parameter values corresponding to the "stage look" are the values stored in the cue when a store operation takes place. Which parameters are stored is determined by the current intensity state of each luminaire and the filter settings.

### Intensity States

One of the most important factors to consider during both cue storing and playback is the intensity state and intensity level of selected channels at the time of the store operation. During store operations, the intensity state will determine which parameters will store data, and for the intensity parameter itself, what value will be stored. During playback, the intensity level will affect the overall intensity output. Intensity states/levels can be controlled using several methods, which include the Intensity encoder, associated intensity state buttons, command-line entry, submasters fader positions, Grand Master fader position, and the Black Out feature.

Because of the complexity of this subject, intensity state/level discussions are provided in stages throughout this manual as follows:

Subject	Explanation
Intensity states for storing cues.	" <a href="#">Intensity States</a> " on page 140.
How faders affect cue storing.	" <a href="#">How Faders Affect Intensity</a> " on page 254.
How faders affect playback.	" <a href="#">Playback Intensity Level</a> " on page 299.

### The Four Intensity States

There are four intensity states that determine which parameters are stored, and in some cases, at what level. These are set by the intensity encoder and/or the intensity state buttons.

- + **Active** - intensity value greater than zero (1-100%). When a luminaire is *active*, it will store data for all parameters (including intensity).
- + **Marked** - intensity state of "marked" (0% level). When a luminaire is *marked*, it will store data for all parameters with intensity stored as "marked" (0% level). When a cue is recalled, a *marked* luminaire will move to the stored position and, if previously *active*, fade out with the luminaire's intensity down time.
- + **Zero** - intensity state of zero ("hard zero", 0% level). A luminaire that is *zero* will only store intensity data, which is stored as a "hard zero" (0% level) along with the luminaire's intensity down time. When a cue is recalled, a *zero* luminaire will fade out with the luminaire's intensity down time. It will not change any other parameter positions because there is no data stored for them.
- + **Out** (*inactive*) - no parameter data (0% level). When a luminaire is *out*, it will not store any parameter data. When a cue is recalled, an *out* (or *inactive*) luminaire will not change parameter positions, but if previously *active*, it will fade out in the cue's out time. (Moving a submaster fader all the way down brings the selected channels to the Out state.)

## Setting Intensity States

**Note:** Some devices (such as moving mirrors, smoke machines, etc.) may not have lamps, however, they must still have an intensity value (*active, marked, or zero*) in order to store information in a cue.

The intensity state can be set by the Intensity encoder or the Intensity State buttons.

The keypad [At] and [Full] commands can also be used to set intensity using a percentage value of 0-100.

The [At] button is used to enter intensity values:

- + <Chan> [n] [At] [m] [Enter] - changes the intensity level of the selected channel to m.
- + <Chan> [n] [Thru] [q] [At] [m] [Enter] - changes the intensity level for the selected range of channels to m.

The [Full] button is used to quickly set intensity to 100%.

- + <Chan> [n] [Full] [Enter] - changes the intensity level of the selected channel to 100%.

### Fader Levels

Since the intensity level plays a large part in storing cues, it is important to note that intensity levels stored in a cue are calculated after the contribution of any selected submasters faders, not before. To simplify the storing of basic cues, ensure that all faders are set at full (100%) and the [Black Out] button is not engaged.

## Storing Cues

**Note:** When [Store] is pressed, the keypad defaults to Cue mode. Therefore, the <Cue> button press is noted as optional.

### Store a basic cue:

- Step 1. Using manual controls, set luminaires in desired "stage look."
- Step 2. Ensure that luminaires are in required intensity state (refer to "**Intensity States**" on page 140).
- Step 3. Press [Store] <Cue> [n] [Enter] - current stage look will be stored as specified cue number (n).

Intensity State Buttons - Applies an intensity state to selected luminaire(s).

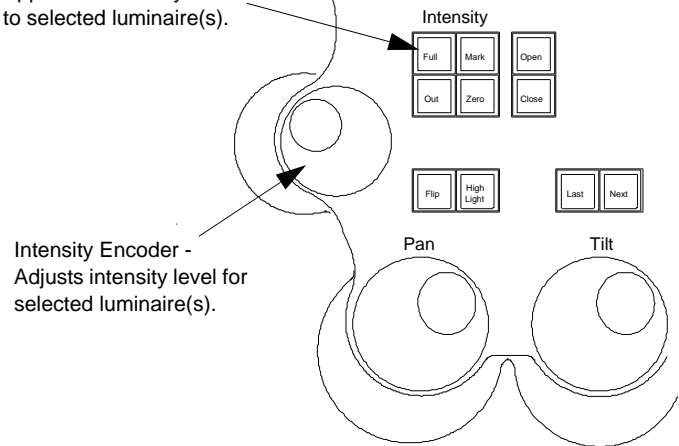

**Note:** The V676 console is shown in this example, however, these buttons are found on all Vx76 console front panels.

## Labeling Cues

Each cue may be given a custom label. When labeling, the name can be entered on the console touchscreen keyboard *or* computer keyboard.

### Store a basic cue with a label:

- Step 1. Using manual controls, set luminaires in desired "stage look."
- Step 2. Ensure that luminaires are in required intensity state (refer to "[Intensity States](#)" on page 140).
- Step 3. Press [Store] <Cue> [n] [Label] [Enter] <xxxxxx> <enter/save>

```
> Store Cue 52 Label *
store cue 52
```

### Change or add a cue label:

- + <Cue> [n] [Label] [Enter] <xxxxxx> <enter/save>.  
*or...*
- + [Label] [Cue] [n] [Enter] <xxxxxx> <enter/save>.  
*or...*
- + [Label] <Cue> [n] [Enter] <xxxxxx> <enter/save>.



### Label the current cue:

- + [Label] [Enter] <xxxxxx> <enter/save>.

### Soft Keyboard Copy/Paste

Buttons for Copy and Paste are available on the soft keyboard. These can be used to copy the entire label to the clipboard or paste the clipboard to the label. The function also allows copy/paste from other sources.

Select multiple fields for copy by holding down the <shift> button. When multiple fields are pasted into a different label, they will go into the same "slots" (fields) as they came from.

## Label Shortcuts

Label Shortcuts allow a user to create a selection of commonly used words that can be used to quickly create new labels.

### To store a selection:

- + Select desired field and press [Store] / <User #> slot to store data into a shortcut field.  
For example, [Store] / <User 3> would store the data into the User 3 slot.

### To recall a selection:

- + Press a <User #> slot to bring the word into the current label field.

In the Cue Label keyboard, multiple shortcuts can be placed consecutively in the label field.

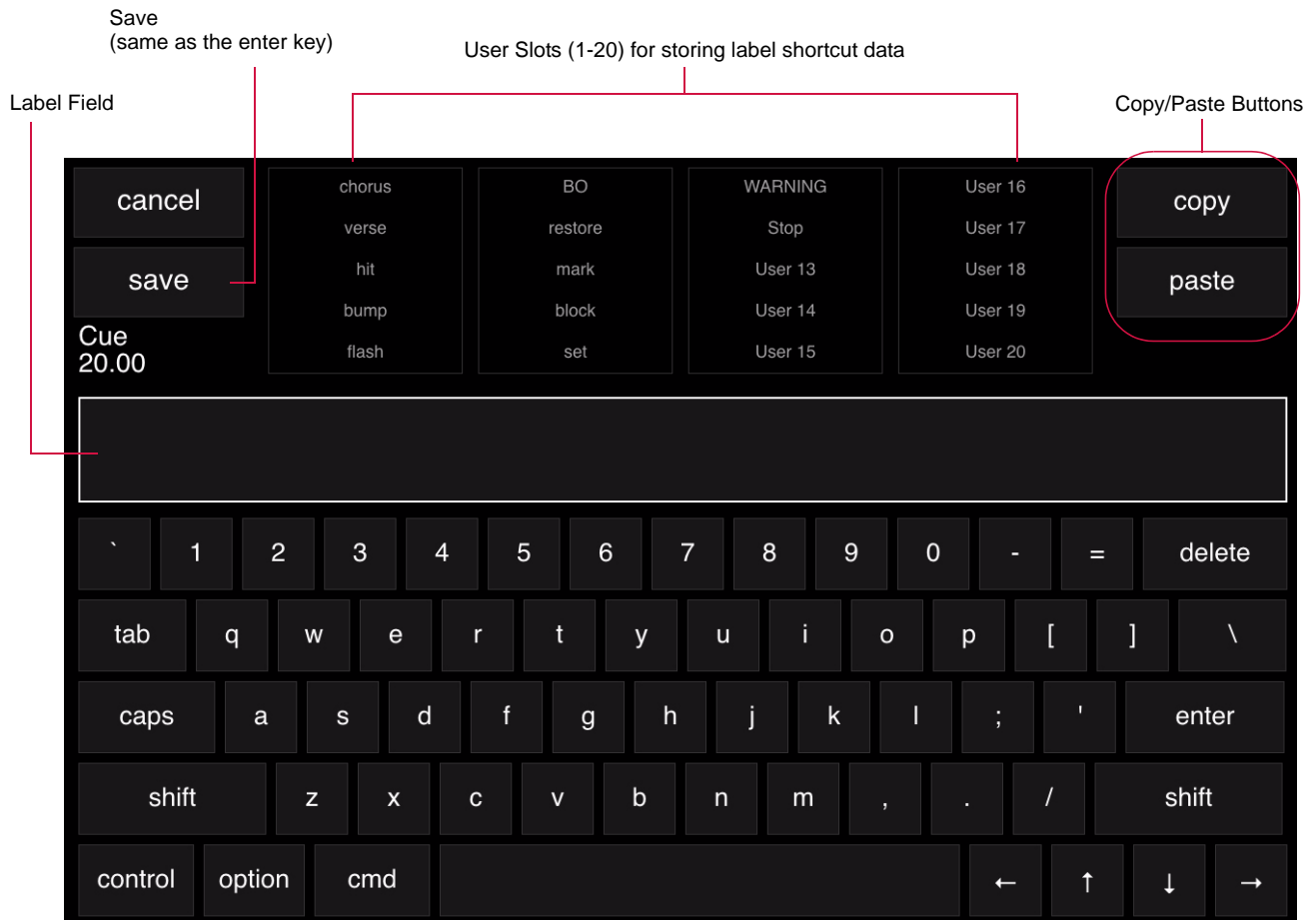



## Modifying Cues

Unlike storing Presets, Beams, and Colors, storing cue data into a cue number that already exists is a replacement action, not an additive action. Therefore, any cue store operation will store the current "stage look" (as defined by the intensity state). To modify a cue, recall the cue, change the parameters as required and then re-store it.

## Deleting Cues

The delete function can be used to erase a stored cue. Since this function does not route through the channel selects, current channel selections are not affected.

When deleted, the cue will also be removed from the cue list.

---

**Note:** When [Delete] is pressed, the keypad defaults to Cue mode. Therefore, the <Cue> button press is noted as optional.

---

### Delete a cue:

- + [Delete] <Cue> [n] [Enter] - deletes the entire specified cue (n).

### Delete a channel from a cue:

- Step 1. Recall cue.
- Step 2. Select required channel.
- Step 3. Press [Out].
- Step 4. Re-store cue by pressing [Store] <Cue> [n] [Enter] (where n is the discrete cue number).

## Undo

The last store, update, or delete action taken on the console can be reversed with the undo command.

### Undo the last store/update/delete command:

- + [Undo] [Store] [Enter].

### Return to recorded state:

- + When in a cue, with selected fixtures that have manual changes, press [Undo] [Channel] [Enter] to send the channels back to their cue state.



## Selected Cue Info Display

The cue data area of the central touchscreen displays information for the selected cue attributes, cue stack, macros, etc. The display can also show board cue or effect information.

Options:

- + To view effect information, touch the effect number.
- + To view board cue information, press the <Board> button.
- + To return to the cue details, touch the cue number.

The main interface shows a table of cues. The selected cue, 355.37, is highlighted. A detailed view of this cue is overlaid on the right side of the screen, showing its stack (0), cue number (355.37), effect (13), and various parameters like Macro 102 and Snap 11.

Cue List	Cue	Effect	Label	Mac	Snap	Link	AF	Out	Loop	Max	Stack Separator
Plan View	355.34	Hit 1						2.00		10.00	
	355.35	Hit 2						2.00		10.00	
	355.36	Hit 3						2.00		10.00	
	355.37	13	Hit 4	102	11		W 0.10	2.00		10.00	
	355.38		Fade Out				W 0.80	2.00		10.00	
	355.39		Restore					2.00		10.00	
	355.40		Hit 1					2.00		10.00	
Utilities	355.41		Hit 2					2.00		10.00	
	355.42		Hit 3					2.00		10.00	
	355.43		Hit 4				W 0.10	2.00		10.00	

Cue Data Area

Press Effect number to display Effect information

The effect information display shows the selected cue (355.37) and effect (13). The effect name is 'White Tick'. Below this, there are buttons for 'Set 6' and 'Seq 13', and a 'White Steel' label.

Press Board button to display Board Cue information

The board cue information display shows the selected cue (355.38) and effect (13). The effect name is 'Fade Out'. Below this, there is a table of board cues:

Board Cue	Label	Link	AF
100			
101	Go Home...		1

# PLAYING BACK CUES

## Basic Playback

After storing a cue, it can be played back using a submaster.

### Play a cue:

Step 1. At keypad, press [Cue] [n] [Enter] or scroll through cue list to select cue. It will be displayed in the keypad window.

```
> Cue 1 *
set cue 1
```

- Step 2. At required submaster, press [Select] to select submaster for playback function.
- Step 3. Press [Load] to place cue in pending file (as shown in submaster display).
- Step 4. Set Grand Master fader at required level.
- Step 5. Set submaster fader at required level.
- Step 6. Press [Go] to play cue.

### Play next cue:

The submaster always sequences, placing the next sequential cue from the cue sheet or any linked cue in its pending file. Linked cues without wait times will await manual execution.

- + Press [Go] again to play next cue.

**Note:** The V276 front panel does not include the [Run], [Stop], and [Step] buttons. Perform these actions using the alternate button combinations, as given below, or use the Submaster HUD.

### Play active cue again:

- + V476/V676: Press [Run]
- + V276: Press [Cmd] / [Back]

### Play previous cue:

- + Press [Back] to play previous cue (previously active on that submaster). Subsequent presses of [Back] will step backwards through cue sheet.

### Stop a running cue / step through cues:

A running cue can be stopped and then stepped through one cue at a time.

- + V476/V676: Press [Stop/Step]
- + V276: Press [Cmd] / [Go]

**Tip** ⇨ If submaster is empty: at keypad press [cue number], then at submaster press [Go]. (Must be valid cue number.)

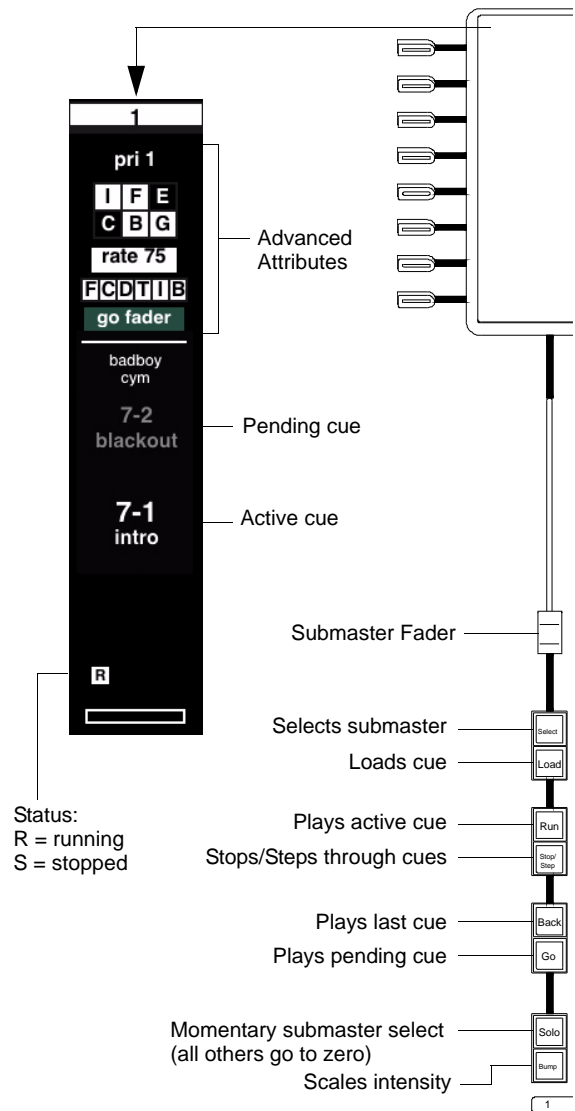
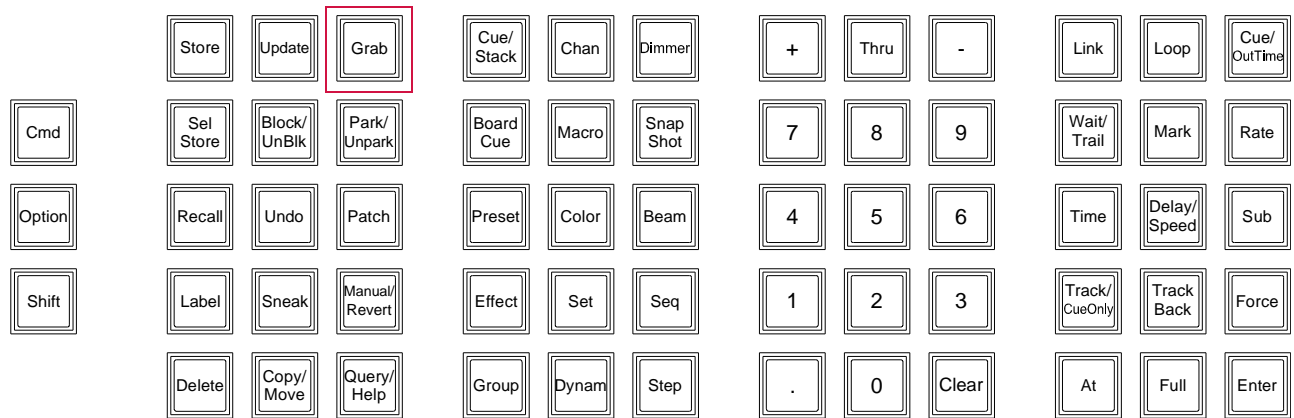

Figure 6-1: V476/V676 Submaster

## Playback Using the Grab Feature

**Note:** The Grab feature was added with Vx76 software version 2.0. The previously unused [Fan Type] button on the command keypad was replaced with a [Grab] button.

Grab provides the capability to withhold functions of a channel from playback. When a channel is "grabbed," the current function filter will determine which parameters are affected. These parameters will respond normally to all manual commands, but will not respond to any submaster control.



Grab is initiated from the command line. When the [Grab] button is pressed, the function filter will automatically open (as with Selective Store), to highlight the fact that the filter applies to Grab and to allow setting of the desired state.

The Grab selection can be set in various ways, including command line and control key combinations. All normal selection rules apply in terms of additive and exclusive selects. For example, [Grab] [1] [Thru] [5] [Enter] will result in channels 1-5 being the only grabbed channels (just like selection would work). [Grab] [+] [1] [Thru] [5] [Enter] would add channels 1-5 to the grab selection.

### Using with the command line:

- + [Grab] [Enter] - Sets the grab selection to current selection (all others ungrabbed). If no channels selected, it would ungrab all.
- + [Grab] (channel select expression) [Enter] - Sets grab selection to expression (all others ungrabbed)
- + [Grab] [0] [Enter] - Sets grab selection to none (ungrabs all).
- + [Grab] [+] (channel select expression) - Grabs additional channels (others are unaffected).
- + [Grab] [-] (channel select expression) - Ungrabs specified channels (others are unaffected).

When channels are grabbed, the channels specified by the grab command will become the *current selection*. For example, if channels 1-10 are selected and [Grab] [20] [Enter] is input on the command line, then Channel 20 will be selected and channels 1-10 deselected.

### Using with other keys:

- + [Grab]+[submaster choose] - Grabs channels controlled by the submaster (all others ungrabbed). ("Choose" is activated by touching the specific submaster on the touchscreen.)
- + [Grab]+[group select] - Grabs channels in group (all others ungrabbed).

When Grab is used as a control key, it will be automatically dismissed on the command line as with other control keys like [Store]. For example, [Grab]+[group select].

### Showing the grab selection:

- + [Group] [Grab] [Enter] - Sets selection to current grab selection.

**Other guidelines:**

- + When a channel is grabbed, the current function filter will be applied. In order to change the function filter, grab it again with a different filter. A grab command with the function filter empty will be ignored.
- + When the grab selection is not empty, the [Grab] button will slow-blink.
- + The Luminaire Status window will indicate grabbed parameters by setting the background color of parameter cells to dark green, as shown below:

Channel	Device	Strobe	Focus	Tilt	Pan	Inten	Blue	--	--	Color	--	Amber	3D	Magenta	Wt
1	VL2000W	0.0%		3.2°	7.7°	66	0.0%					0.0%	0'4 -3'8 -11'7	0.0%	
2	VL2000W	0.0%		3.2°	7.7°	66	0.0%					0.0%	1'10 -3'8 -11'7	0.0%	
3	VL2000W	0.0%		3.2°	7.7°	66	0.0%					0.0%	3'4 -3'8 -11'7	0.0%	
4	VL2000W	0.0%		3.2°	7.7°	66	0.0%					0.0%	4'10 -3'8 -11'7	0.0%	
5	VL2000W	0.0%		3.2°	7.7°	66	0.0%					0.0%	6'4 -3'8 -11'7	0.0%	
6	VL2000W	0.0%		0.0°	0.0°		0.0%					0.0%	7'7 -4'4 -11'7	0.0%	
7	VL2000W	0.0%		0.0°	0.0°		0.0%					0.0%	9'1 -4'4 -11'7	0.0%	
8	VL2000W	0.0%		0.0°	0.0°		0.0%					0.0%	10'7 -4'4 -11'7	0.0%	



## 7.

# DYNAMICS

This chapter provides instructions for using the dynamics feature.

- + [DYNAMICS OVERVIEW](#)
- + [DYNAMICS OPERATION](#)

# DYNAMICS OVERVIEW

## What is a Dynamic?

The Dynamics feature provides a powerful and quick method for creating waveform-based effects which can be applied to multiple channels. Controls such as waveform type, bias, direction, gravity, rate, size, and offset are available to customize and implement the dynamics.

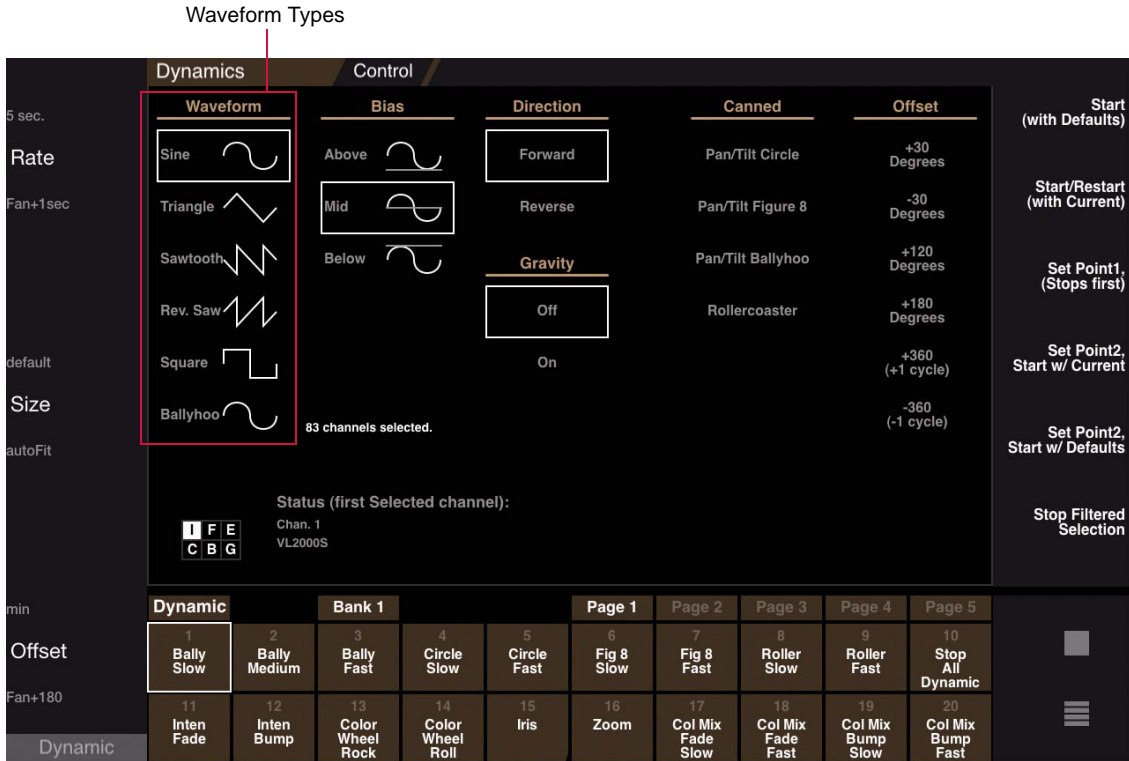

Pre-programmed "Canned" Dynamics

20 "canned" dynamics are included for immediate use, while up to a total of 500 custom dynamics may be created and stored in the Dynamics palette. Dynamics may also be stored into presets or directly into cues. (Refer to **"Methods For Storing Dynamics"** on page 152 for more information.)

It is important to note that everything about dynamics works in conjunction with the Function Filter. The parameter must be selected in the filter before it can be added or modified in the dynamic. (Refer to **"Function Filter"** on page 93 for more information regarding filter operations.)



## Dynamics Super Palette

Dynamics can be created and customized using the Dynamics super palette. The Dynamics super palette can be accessed at the palette displays available on the front panel (V476/V676 only) or via the Palette window (available from the Operation menu -- refer to "**Desktop Palettes Window**" on page 108).

**Note for V676 console users:** The Dynamics super palette can be accessed in any of the front panel touchscreen displays, however, it is recommended that it be used in one of the left displays so that the associated encoders may also be used.

### Dynamics Super Palette

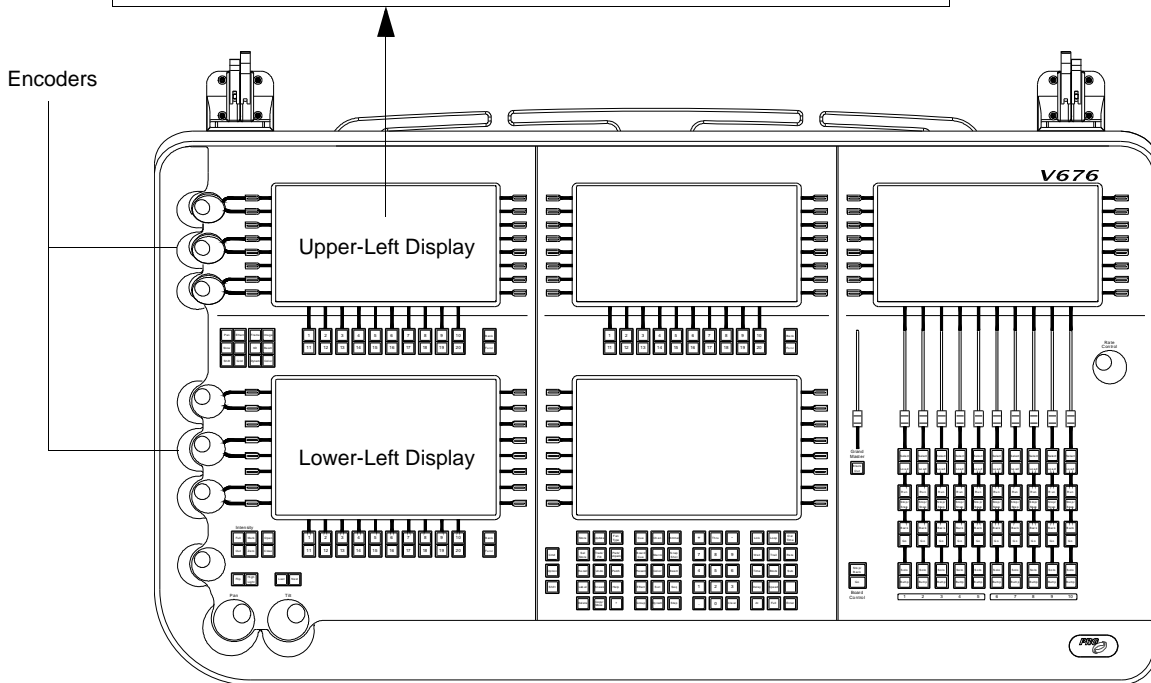
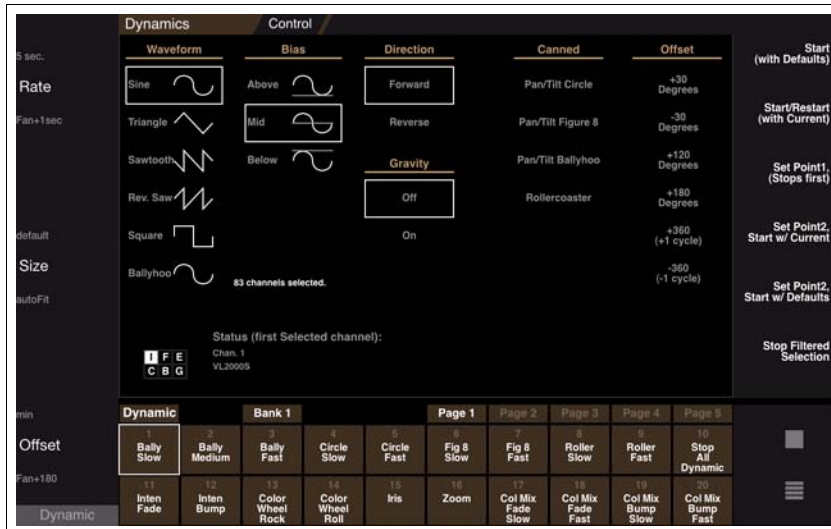

Figure 7-1: Accessing Dynamics Super Palette on V676 Front Panel

## Basic Guidelines

While working with dynamics, it is important to understand the following concepts:

- + Dynamics are not channel specific (they are a starting point for the dynamic).
- + Unlike other palettes, dynamics are not luminaire specific. For example, if a dynamic is created using a Bad Boy® Spot Luminaire, it can be applied to any other luminaire.
- + Everything about dynamics works in conjunction with the Function Filter. The parameter you are working with must be selected in the filter. Rate, size, offset, etc. are stored as a single value.
- + Fanned Offset settings are NOT stored with the dynamic. *This is an important point which is discussed in the following section.*

## Methods For Storing Dynamics

Like other palette items (color, beam, group, etc.), dynamics are given a discrete number. Once stored, they can be accessed in the command line or in the Dynamics palette. A Dynamics century palette is also available for viewing a set of 100 dynamics. The first 20 are pre-programmed canned dynamics, while the rest are empty.

Although dynamics can be stored into these empty palettes, it is important to note that Fanned Offset settings are NOT stored with the dynamics in this case. The empty palettes can be used as a good starting point to store a dynamic - since they can be fanned later, if desired - but if Fanned Offset settings need to be stored, it is best to store the dynamics as presets, cues, or macros.

		Dynamic		Bank 1								
		1	2	3	4	5	6	7	8	9	10	
open	Z Pos	Bally Slow	Bally Medium	Bally Fast	Circle Slow	Circle Fast	Fig 8 Slow	Fig 8 Fast	Roller Slow	Roller Fast	Stop All Dynamic	Canned Dynamics (pre-programmed)
other		Inten Fade	Inten Bump	Color Wheel Rock	Color Wheel Roll	Iris	Zoom	Col Mix Fade Slow	Col Mix Fade Fast	Col Mix Bump Slow	Col Mix Bump Fast	
		21	22	23	24	25	26	27	28	29	30	
		31	32	33	34	35	36	37	38	39	40	
open	Wheel 2	41	42	43	44	45	46	47	48	49	50	User Dynamics
close		51	52	53	54	55	56	57	58	59	60	
		61	62	63	64	65	66	67	68	69	70	
		71	72	73	74	75	76	77	78	79	80	
open	Wheel	81	82	83	84	85	86	87	88	89	90	
close		91	92	93	94	95	96	97	98	99	100	
	Color 1											



# DYNAMICS OPERATION

## Canned Dynamics









20 pre-programmed dynamics (referred to as *canned* dynamics) are provided to aid programmers in developing shows more rapidly. When opening a new show file, these can be found in Bank 1 of the Dynamics palette as shown below:

Dynamic	Bank 1				Page 1	Page 2	Page 3	Page 4	Page 5
1 Bally Slow	2 Bally Medium	3 Bally Fast	4 Circle Slow	5 Circle Fast	6 Fig 8 Slow	7 Fig 8 Fast	8 Roller Slow	9 Roller Fast	10 Stop All Dynamic
11 Inten Fade	12 Inten Bump	13 Color Wheel Rock	14 Color Wheel Roll	15 Iris	16 Zoom	17 Col Mix Fade Slow	18 Col Mix Fade Fast	19 Col Mix Bump Slow	20 Col Mix Bump Fast

The following is a list of all included canned dynamics, by number:

No.	Name	Description	Bank	Page
1	Bally Slow	Slow ballyhoo for selected channels	1	1
2	Bally Medium	Medium speed Ballyhoo for selected channels	1	1
3	Bally Fast	Fast Ballyhoo for selected channels	1	1
4	Circle Slow	Slow Circle for selected channels	1	1
5	Circle Fast	Fast Circle for selected channels	1	1
6	Figure 8 Slow	Slow Figure 8 for selected channels	1	1
7	Figure 8 Fast	Fast Figure 8 for selected channels	1	1
8	Roller Slow	Slow Roller Coaster for selected channels	1	1
9	Roller Fast	Fast Roller Coaster for selected channels	1	1
10	Stop All Dynamic	Stops all dynamics for selected channels	1	1
11	Intensity Fade	Intensity fade dynamic	1	1
12	Intensity Bump	Intensity Bump dynamic	1	1
13	Color Wheel Rock	Color Wheel Rock	1	1
14	Color Wheel Roll	Color Wheel Spin	1	1
15	Iris	Beam Iris dynamic	1	1
16	Zoom	Zoom dynamic	1	1
17	Color Mix Fade Slow	Color Mixer slow fade (Mag, Amb, Blue)	1	1
18	Color Mix Fade Fast	Color Mixer fade fast (Mag, Amb, Blue)	1	1
19	Color Mix Bump Slow	Color Mixer slow bump (Mag, Amb, Blue)	1	1
20	Color Mix Bump Fast	Color Mixer fast bump (Mag, Amb, Blue)	1	1

Four additional canned dynamics are available in the Dynamics super palette. These can be used when building custom dynamics, and are not to be confused with the bank of 20 pre-programmed dynamics.

Dynamics		Control			
Waveform	Bias	Direction	Canned	Offset	
Sine 	Above 	Forward	Pan/Tilt Circle	+30 Degrees	
Triangle 	Mid 	Reverse	Pan/Tilt Figure 8	-30 Degrees	
Sawtooth 	Below 	<b>Gravity</b>	Pan/Tilt Ballyhoo	+120 Degrees	
Rev. Saw 		Off	Rollercoaster	+180 Degrees	
Square 		On		+360 (+1 cycle)	
Ballyhoo 				-360 (-1 cycle)	

## Playing Back a Canned Dynamic

This section provides instructions for applying dynamics to channels for immediate playback.

### To play back a dynamic:

- Step 1. Select required channels.
- Step 2. At front panel, bring up Dynamics palette.

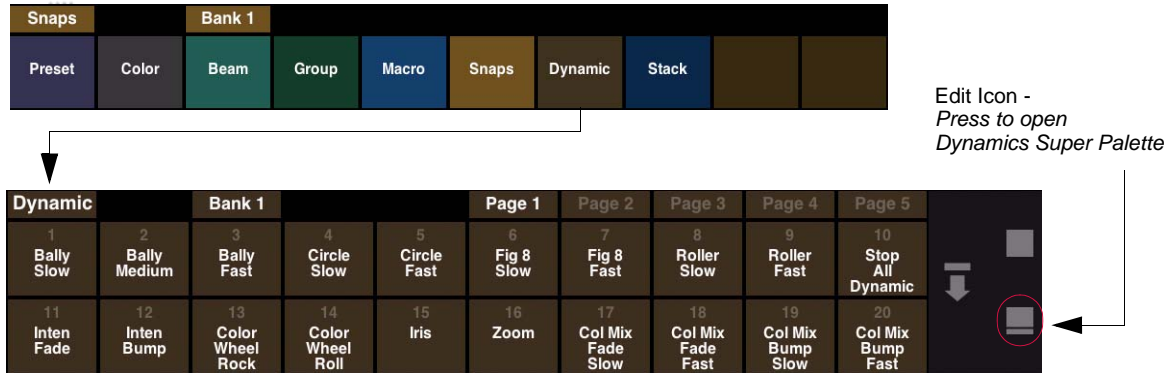

- Step 3. Press Edit icon to bring up Dynamics super palette.

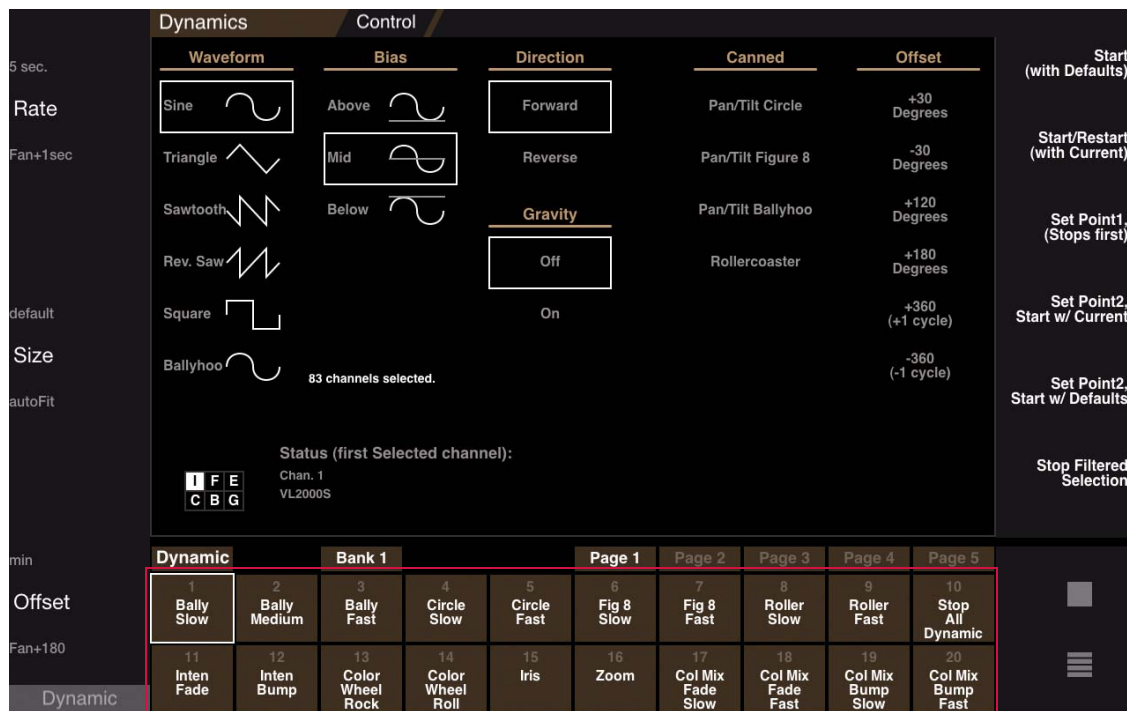

- Step 4. At Dynamics palette, select a canned dynamic. (A white box will appear around the selected item.) The dynamic will be immediately applied to the selected channels and will begin running.
- Step 5. At soft encoders, press [Dynam] button to map dynamic options to encoders. Adjust Rate, Size, and Offset by turning encoders. (Refer to "Using the Encoders with Dynamics" on page 157 for more detailed information.)

- Step 6. Randomize the dynamic by applying a fan:
- Open Function Filter by pressing "filter" in central touchscreen.
  - Select parameter(s) to fan.
  - Press <fan mode> button to choose fan type: Left fan, Right fan, Center fan, Ends fan, and Tilt fan.
  - Press and hold [Fan] button while turning an encoder. (Refer to "Fan" on page 71 for more detailed information.) The dynamic should become more random as the fan is applied.

**Tip** ⇒ Double-clicking the [Fan] button will latch the encoder fan mode on (LED will flash). Double-click again to turn the fan mode off.

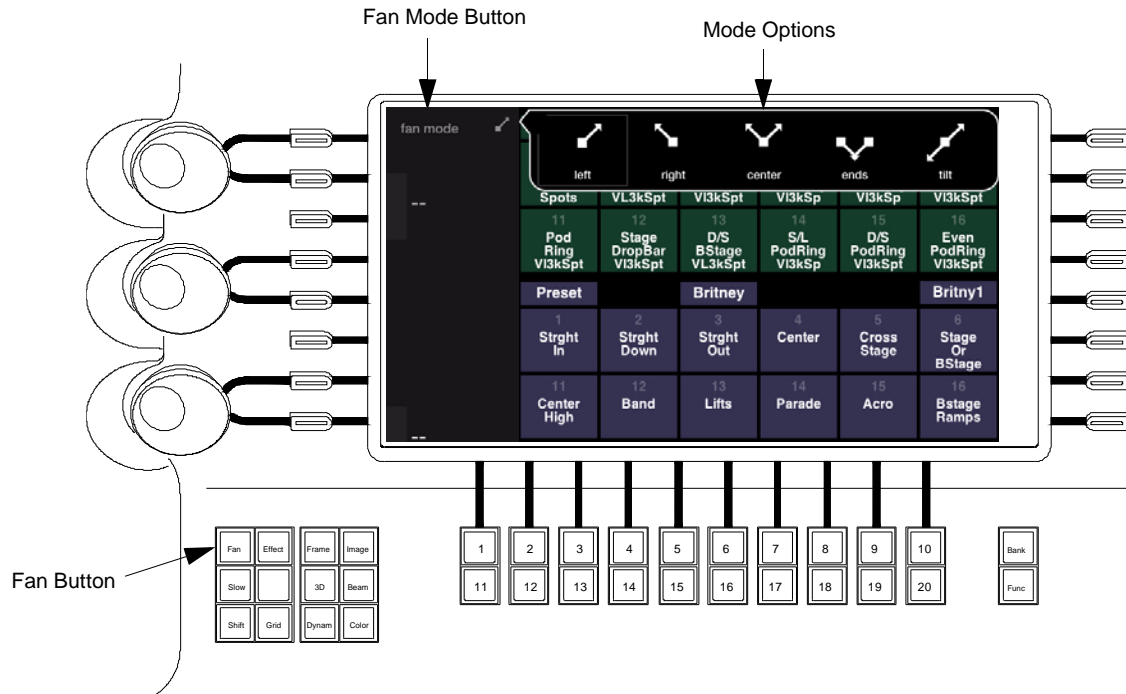

**Note:** The V676 console is shown in this example, however, this button is found on all Vx76 console front panels.

Figure 7-2: Fan Button

**Note:** Dynamics stored in the palette will NOT retain Fanned Offset settings.

- Pile-on more canned dynamics by selecting more items in palette or stop *all* dynamics by pressing <Stop All> button.
- To store a dynamic as a cue or preset, refer to "Storing Dynamics in Cues/Presets" on page 160.

## Using the Encoders with Dynamics

When [Dynam] is selected at the soft encoders, the encoders will be mapped so they can be used to adjust the dynamic settings. Mapping is as follows:

- **RATE** (5 sec / +1 sec)  
 w/ [Shift] button pressed - RATE (5 sec / -1 sec)  
 w/ [Fan] button pressed - RATE (5 sec / fan +1 sec)  
 This encoder changes the rate of a dynamic on parameters selected in the Filter window. CCW speeds up the rate, while CW slows the rate down. The rate can also be fanned.
- **SIZE** (default / autoFit)  
 This encoder changes the size of a dynamic on parameters selected in the Filter window. CCW decreases the size, while CW increases the size. The size can also be fanned.  
 autoFit - automatically chooses the maximum size dynamic.
- **OFFSET** (min / +120)  
 w/ [Shift] button pressed - OFFSET (min/-180)  
 w/ [Fan] button pressed - OFFSET (min/fan +180)  
 This encoder is used to determine where along the waveform, the dynamic should start. The Offset is measured in degrees where a complete waveform is 360 degrees (1 cycle). This function can be used to create "multi" looks when the offset is fanned across channels. (Note that the minimum is 0 degrees.)

*Example:*

- 1) Select 20 channels.
- 2) Open Function Filter by pressing "filter" in central touchscreen. Select <Tilt>.
- 3) Start dynamic and set rate and speed.
- 4) Set a fan.
- 5) Press [+120] button (i.e. the lower button) to bring up offset options:  
 +30 Degrees, -30 Degrees, +120 Degrees, +180 Degrees, +360 / +1 Cycle, -360 / -1 Cycle.  
 Selecting one of these options will fan that particular offset evenly across all of the selected channels. You will now see the luminaire doing a complete single wave. Increasing the offset will start creating multiple waves. For example, increasing the offset to 720 degrees will make two waves.

Once one of these options has been selected, the lower OFFSET button will display the selected option parameter instead of the default (+360). For example, if +120 Degrees is selected, the OFFSET buttons will now read "min" and "+120".

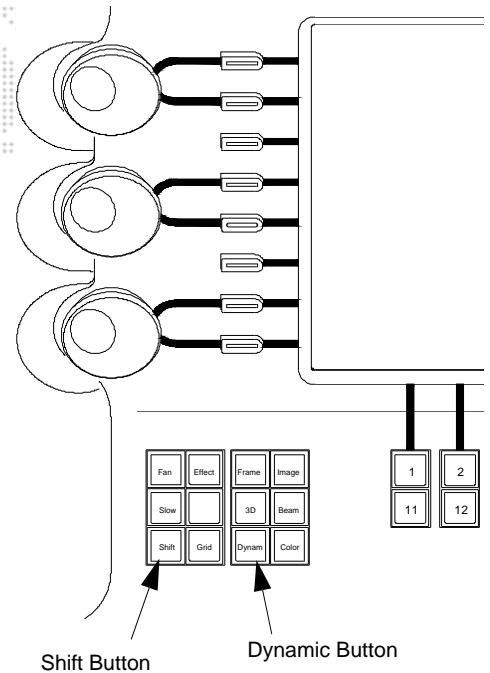

**Note:** The V676 console is shown in this example, however, these buttons are found on all Vx76 console front panels.

Figure 7-3: Shift/Dynamic Button

When [Dynam] is selected...

- + Turning the RATE encoder will display the rate (such as 5.00).
- + Turning the SIZE encoder will display the size percentage (such as 78%).

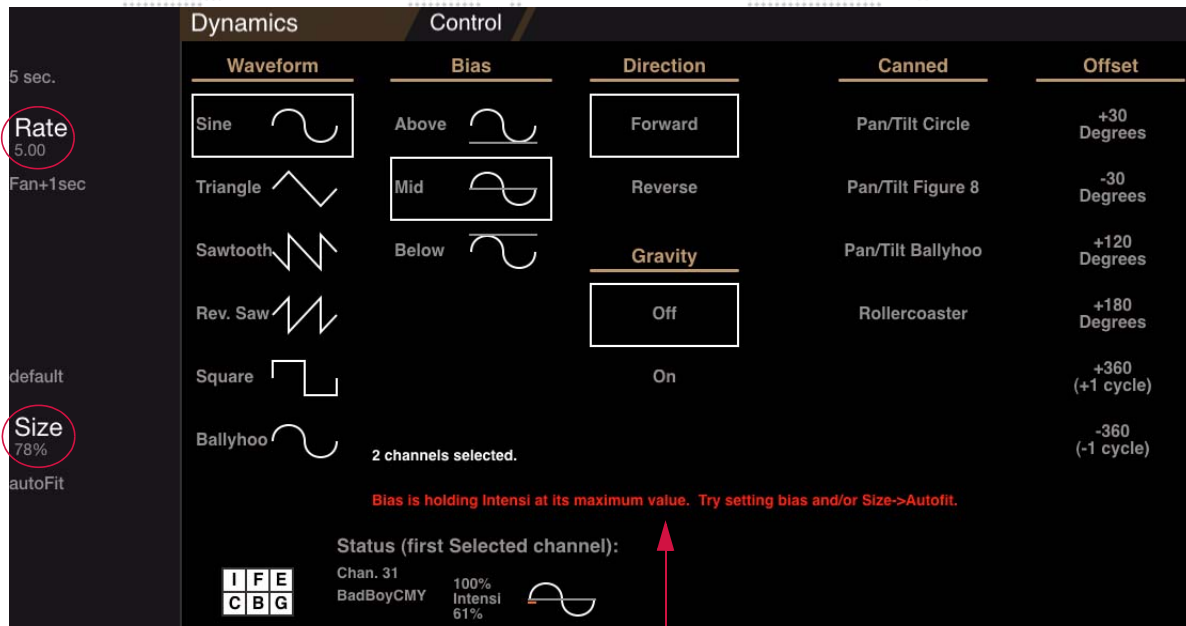

Warning Message

## Warning Messages

The warnings messages displayed in red on the Dynamics super palette are important. If problems occur during programming, these will indicate why the dynamic is not behaving as expected, or why commands appear to have no effect. The following is a list of primary warnings:

- + No selected channels.
- + Function filter has no parameters.
- + Current selected channel has no parameters with current function filter.
- + Fan will do nothing with only one channel selected.
- + Fan will only change second channel with only two channels selected.
- + Fanned encoder moves may appear very small with so many channels selected (more than 50).
- + Bias is holding Intensity at its maximum value. Try setting bias and/or Size->Autofit. (See "About Clipping" below.)

## About Clipping

Dynamics are often partially or fully clipped by the parameters maximum and/or minimum value. For example, if running an Intensity dynamic with intensity at 100%, and bias set to "Above," the dynamic will be fully clipped at 100% and will have no apparent effect. As the intensity is dialed down below 100%, the dynamic will be partially clipped at 100% until intensity is dialed down low enough to match the dynamic size.

Sometimes, clipping is undesirable, but partially clipped Intensity dynamics with very large sizes can produce interesting strobe-like waveforms.

An Intensity dynamic with a size of 1024 (400%) will have a waveform which is four times as large as the Intensity range of 0 to 255. Prior to Vx76 software version 3.0, size was not scaled by the intensity value, so the size was fixed. However, now the Intensity dynamic size is scaled by the intensity value itself, so that Intensity dynamics can be faded out easily.

This rule only applies to the Intensity parameter. For example, if intensity is at 50%, intensity will rock between 50% and 200%.

- + If intensity is at 10%, Intensity will rock between 10% and 40%.
- + If Intensity is at 1%, Intensity will rock between 1% and 4%.
- + If Intensity is Marked, Intensity will remain at 0.
- + If Intensity is Out, ALL dynamics for all parameters will STOP.

## Fanning Dynamic Offset

The true power of dynamics is achieved by fanning the dynamic "offset."

### To fan dynamic offset:

- Step 1. Select 20 channels.
- Step 2. Stop any previously running dynamic by hitting the "Stop Dynamic" button or select Dynamic Palette #10 "Stop All Dynamic."

Dynamic		Bank 1			Page 1	Page 2	Page 3	Page 4	Page 5
1 Bally Slow	2 Bally Medium	3 Bally Fast	4 Circle Slow	5 Circle Fast	6 Fig 8 Slow	7 Fig 8 Fast	8 Roller Slow	9 Roller Fast	10 Stop All Dynamic
11 Inten Fade	12 Inten Bump	13 Color Wheel Rock	14 Color Wheel Roll	15 Iris	16 Zoom	17 Col Mix Fade Slow	18 Col Mix Fade Fast	19 Col Mix Bump Slow	20 Col Mix Bump Fast

- Step 3. Open Function Filter by pressing "filter" in central touchscreen. Select only <Tilt>.
- Step 4. Turn fan off. (You can fan dynamic rate and size as well as offset, but typically you only want to fan offset.)
- Step 5. Start dynamic and set rate and size. (Refer to "Using the Encoders with Dynamics" on page 157.)
- Step 6. Turn fan on. Fan by holding down the [Fan] button or double-clicking the [Fan] button to latch it on. Notice that the labels for offset change to [fan +120] when fan is on.
- Step 7. Press [+120] button (i.e. the lower button) to bring up offset options:
  - a. +30 Degrees, -30 Degrees, +120 Degrees, +180 Degrees, +360 / +1 Cycle, -360 / -1 Cycle. Selecting one of these options will fan that particular offset evenly across all of the selected channels.
  - b. You will now see the luminaire doing a complete single wave. Increasing the offset will start creating multiple waves. For example, increasing the offset to 720 degrees will make two waves.
  - c. Once one of these options has been selected, the lower OFFSET button will display the selected option parameter instead of the default (+360). For example, if +120 Degrees is selected, the OFFSET buttons will now read "min" and "+120".
- Step 8. Turn fan off.
- Step 9. Try repeating the above steps for other parameters such as Intensity or Pan. Typically, you only select one parameter at a time when editing a dynamic (for example, Intensity, Pan, Tilt). An exception would be color mixers (refer to "Point-To-Point Dynamics" on page 163).
- Step 10. When a desired "stage look" is achieved, store this as a Preset. Since the dynamic palette does not store fan information, its usefulness is limited (refer to "Methods For Storing Dynamics" on page 152.)

---

**Note:** Complex dynamics can also be stored as macros. For this example, do this by pressing [Store] [Macro] [Enter] at the command-line keypad before Step 2, and then after Step 8, press [Store] [Macro] [n] [Enter] - where n is the number of the macro palette where you wish to store the recorded sequence.

---

## Storing Dynamics in Cues/Presets

Canned or custom dynamics can be added to the parameters stored in cues or presets. To store a dynamic without any base values, a palette must be used (see below).

*Guidelines:*

- + Fixture parameters use parameter time to perform transitions into or out of dynamic states, such as rocks or ballyhoos.
- + The same time value is used for the parameter value transition and the dynamic transition.
- + Transitioning between different types of dynamics may not always be smooth.

**To store in a cue:**

- + Store cue using normal cue storing operations. (Refer to "Creating Cues" on page 140.)

**To store in a preset:**

When storing in a preset, you must first select the parameters in the Function Filter and then press <Dynamic>.

Step 1. Open Function Filter by pressing "filter" in central touchscreen. (Refer to "Function Filter" on page 93.)

Step 2. Select parameter(s) to be stored.

Step 3. At right side of Function Filter, press <Dynamic> button.

Step 4. Store preset as usual. (Refer to "Storing, Modifying, and Recalling Presets" on page 117.)

Selected Parameter (highlighted)

Function Filter			Wheel 2	Beam2	--	E Index	Timing		
			Wheel	Framing	--	Effect	Dynamic		
		--	Magenta	Strobe	--	Index	DynOnly		
Page 1		Tilt	Yellow	Zoom	Frost	R Gobo	Misc		
All		Inten	Pan	Cyan	Beam	Edge	Sneak3D		
Clear		INTEN	FOCUS	COLOR	BEAM	EDGE	GOBO		
1	2	3	4	5	6	7	8	9	10
11	12	13	14	15	16	17	18	19	20

Dynamic Button

## Storing Dynamics in Macros

Complex dynamics can also be stored as macros. For example, press [Store] [Macro] [Enter] at command-line keypad, then create a dynamic. When complete, press [Store] [Macro] [n] [Enter] - where n is the number of the macro palette where you wish to store the recorded sequence.

Refer to "Macros" on page 233 for more information about recording macros.



## Palette Store Dynamic Only

The Store Dynamic Only feature enables the creation of Color or Beam palette entries that contain Parameter and/or Dynamic values. This can be:

- + Parameter value only
- + Dynamic value only
- + Both Parameter and Dynamic values

---

**Note:** This functionality is not available for Presets, Selective Store, Selective Recall, or Effect Sequences.

---

The Parameter and Dynamic values can be viewed in the Luminaire Status window by using the P and D buttons located at the bottom of the window. This is useful because it shows what is the value and what is the dynamic.

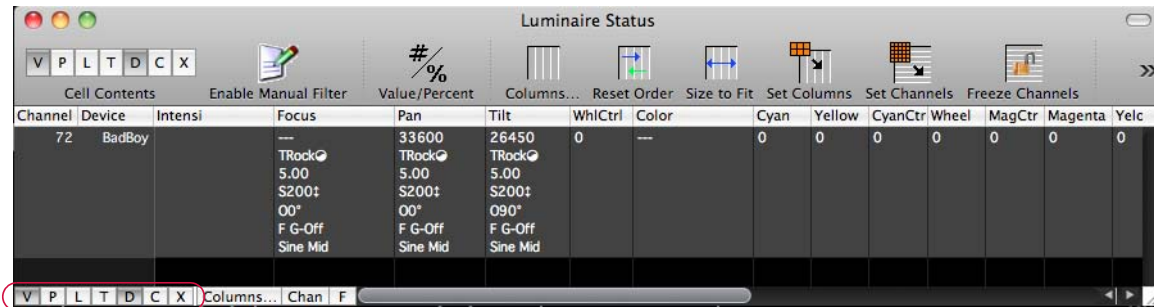

The Function Filter determines what is stored (function, dynamic, or dynamic only) as follows:

- + Function only - only P data stored.
- + Function and dynamic - P + D data stored.
- + Function and dyn only - only D data stored.

### To store Dynamic Only values:

- Step 1. Open Function Filter by pressing "filter" in central touchscreen. (Refer to "Function Filter" on page 93.)
- Step 2. Select parameter(s) to be stored.
- Step 3. At right side of Function Filter, press <DynOnly> button.

Step 4. Store palette entry as normal. (Refer to "[Front Panel Palette Displays \(V476/V676 Only\)](#)" on page 106 for more information about the Palette features.)

Selected Parameter (highlighted)

Function Filter				Wheel 2	Beam2	--	E Index	Timing	
				Wheel	Framing	--	Effect	<b>Dynamic</b>	
Page 1			--	Magenta	Strobe	--	Index	DynOnly	
			Tilt	Yellow	Zoom	Frost	R Gobo	Misc	
All		<b>Inten</b>	Pan	Cyan	Beam	Edge	Gobo	Sneak3D	
Clear		<b>INTEN</b>	<b>FOCUS</b>	<b>COLOR</b>	<b>BEAM</b>	<b>EDGE</b>	<b>GOBO</b>	<b>TO CUE</b>	
1	2	3	4	5	6	7	8	9	10
11	12	13	14	15	16	17	18	19	20

Dynamic Button

**Note:** When working with the Color palette, the System Settings window will change the functionality. Check the "Use Func. Filter on Color Store" setting for best results. Refer to "[System-Wide Palette Store Options](#)" on page 105.

**Note:** For Color palette settings where the filter selection is not used, all the color parameters still store the dynamic data.

### Gravity (Roller Coaster Effect)

When enabled, the Gravity setting adds a "roller coaster" type effect to a dynamic. This causes the dynamic to accelerate faster on one half of a cycle, then slow down on the other half of a cycle.

The screenshot shows the Dynamics Control interface with the following settings:

- Waveform:** Sine, Triangle, Sawtooth, Rev. Saw, Square, Ballyhoo
- Bias:** Above, Mid, Below
- Direction:** Forward, Reverse, Gravity (On)
- Canned:** Pan/Tilt Circle, Pan/Tilt Figure 8, Pan/Tilt Ballyhoo, Rollercoaster
- Offset:** +30 Degrees, -30 Degrees, +120 Degrees, +180 Degrees, +360 (+1 cycle), -360 (-1 cycle)

+ **Gravity > Off or On** - Gravity can be turned on or off for any dynamic, with Off being the default setting. Gravity can also be added to custom dynamics. Keep in mind that gravity can be applied to any parameter, but the effect is often very subtle on anything but pan/tilt.

- + **Bias > Above or Below** - When using gravity, you will likely need to select a bias of either above or below to achieve the desired effect.
- + **Canned > Rollercoaster** - The best example for using gravity is by turning it on after starting the "Rollercoaster" dynamic. (None of the canned dynamics have gravity on by default.) Note that the dynamic palette numbers 8 and 9 ("Roller slow" and "Roller fast") do not fan pan/tilt like "Rollercoaster" does.

#### **Build a roller coaster dynamic from scratch:**

- Step 1. Select five or more fixtures and focus them (pan/tilt) at one single point on stage. (Be sure that the five fixtures are all oriented so that tilt moves them in the same direction.)
- Step 2. Store this position as a pan/tilt preset. (It will be used later to restart the dynamic.) Refer to "**Storing Dynamics in Cues/Presets**" on page 160.
- Step 3. Turn fan Off.
- Step 4. At Function Filter, select ⟨Pan⟩.
- Step 5. Start dynamic and select Sine Waveform with settings: Rate = 6 seconds, Size = 200, Offset = 0
- Step 6. At Function Filter, select ⟨Tilt⟩.
- Step 7. Start dynamic and select Sine Waveform with settings: Rate = 3 seconds, Size = 120, Offset = 0
- Step 8. At Function Filter, select both ⟨Pan⟩ and ⟨Tilt⟩.
- Step 9. Turn fan On.
- Step 10. Fan dynamic Offset over 90 degrees (1/4th of a cycle).
- Step 11. At this point it's likely that pan and tilt will not be synchronized since their dynamics were started separately. To synchronize, select both ⟨Pan⟩ and ⟨Tilt⟩ in Function Filter and store as a second pan/tilt preset.
- Step 12. With both ⟨Pan⟩ and ⟨Tilt⟩ selected in Function Filter, press ⟨Stop Filtered Selection⟩ in the Dynamics super palette to stop dynamic.
- Step 13. Recall second stored pan/tilt preset. Pan/tilt should now be synchronized and selected fixtures will appear to chase each other like roller coaster cars.
- Step 14. Try adding dynamic gravity to pan and/or tilt to see how it affects the look. (You may have to flip pan/tilt to achieve the desired look.) This creates a simple roller coaster with two "hills." To add more hills, change the pan dynamic rate to a multiple of tilt's rate (9 seconds, 12, 15, etc.), and increase the Pan Size accordingly.

### **Point-To-Point Dynamics**

Point-To-Point dynamics is a unique feature which allows you to create a dynamic between two palette or preset points. These can consist of a preset, color, or beam. For example, between two colors: blue and red. In this case BLUE would be the *first point* and RED would be the *second point*.

Several buttons at the right side of the Dynamics super palette are available for use with this feature:

- + **Set Point 1, (Stops first)** - Sets currently selected palette item as the first (start) point.
- + **Set Point 2, Start w/ Current** - Sets currently selected palette item as the second point using current settings for waveform, bias, direction, etc. When pressed, the dynamic will begin running.
- + **Set Point 2, Start w/ Defaults** - Sets currently selected palette item as the second point using the default settings for waveform, bias, direction, etc. When pressed, the dynamic will begin running.

#### **To create a point-to-point dynamic:**

- Step 1. Be sure all dynamics are stopped by pressing ⟨Stop All⟩ button.
- Step 2. Select required channels.
- Step 3. Open Function Filter by pressing "filter" in central touchscreen. (Refer to "**Function Filter**" on page 93.)
- Step 4. Select parameter(s).
- Step 5. Using palettes, choose first point. (This could be a preset, color, or beam.)

Step 6. Press [Set Point 1] button.

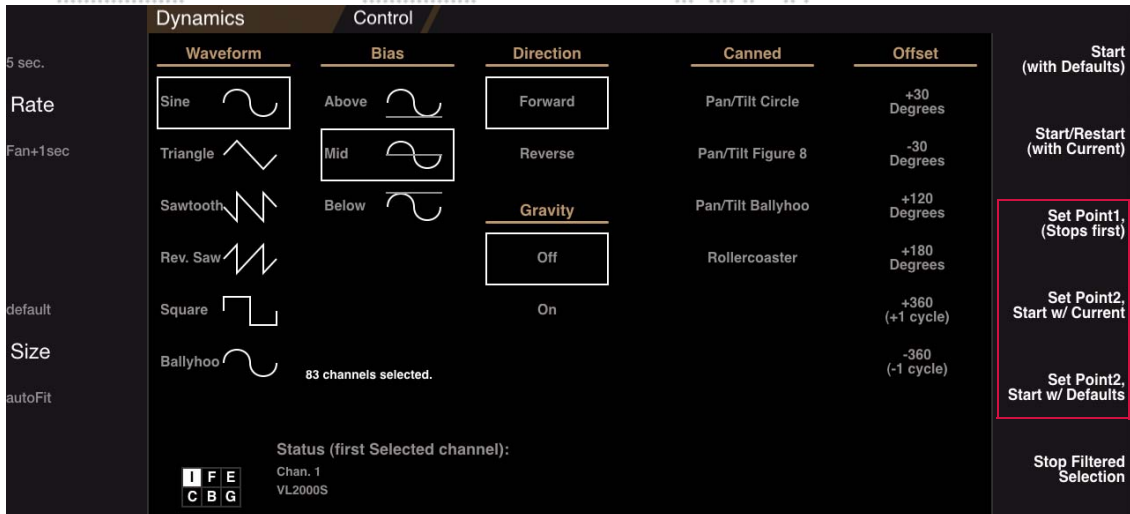

Step 7. Using palettes, choose second point.

Step 8. Press either of the [Set Point 2] buttons as desired. Dynamic will begin running.

Step 9. Modify as necessary. (Refer to "Storing Dynamics in the Dynamics Palette" on page 165.)

---

**Note:** Size cannot be modified for point-to-point dynamics. This will result in undesirable actions.

---

Step 10. Store as Dynamics palette item, cue, or preset.

## Storing Dynamics in the Dynamics Palette

Dynamics can also be created and stored in the Dynamics palette. (Just keep in mind that the Dynamics palette DOES NOT store fan mode settings. Therefore, it is recommended that dynamics be stored as presets, cues, or even macros.)

### To create a new dynamic:

- Step 1. Select required channels.
- Step 2. At front panel, bring up Dynamics palette. (Refer to "Dynamics Super Palette" on page 151 for additional information.)

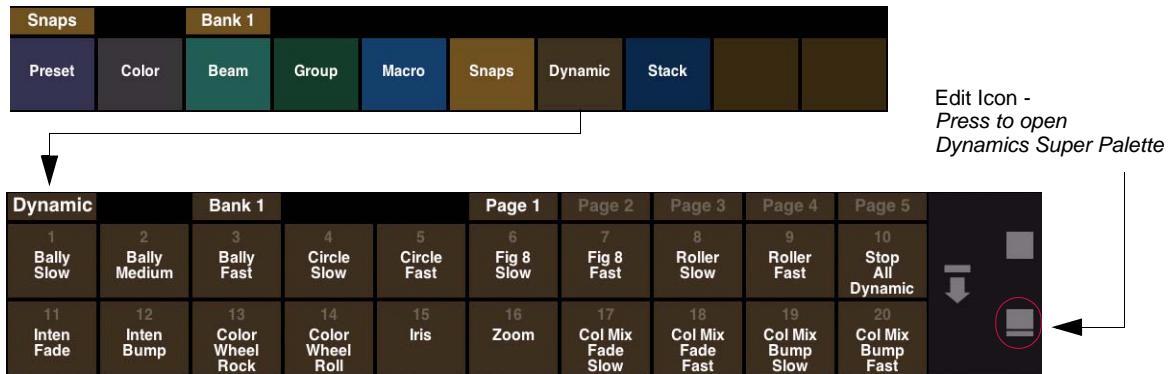

- Step 3. Press Edit icon to bring up Dynamics super palette:

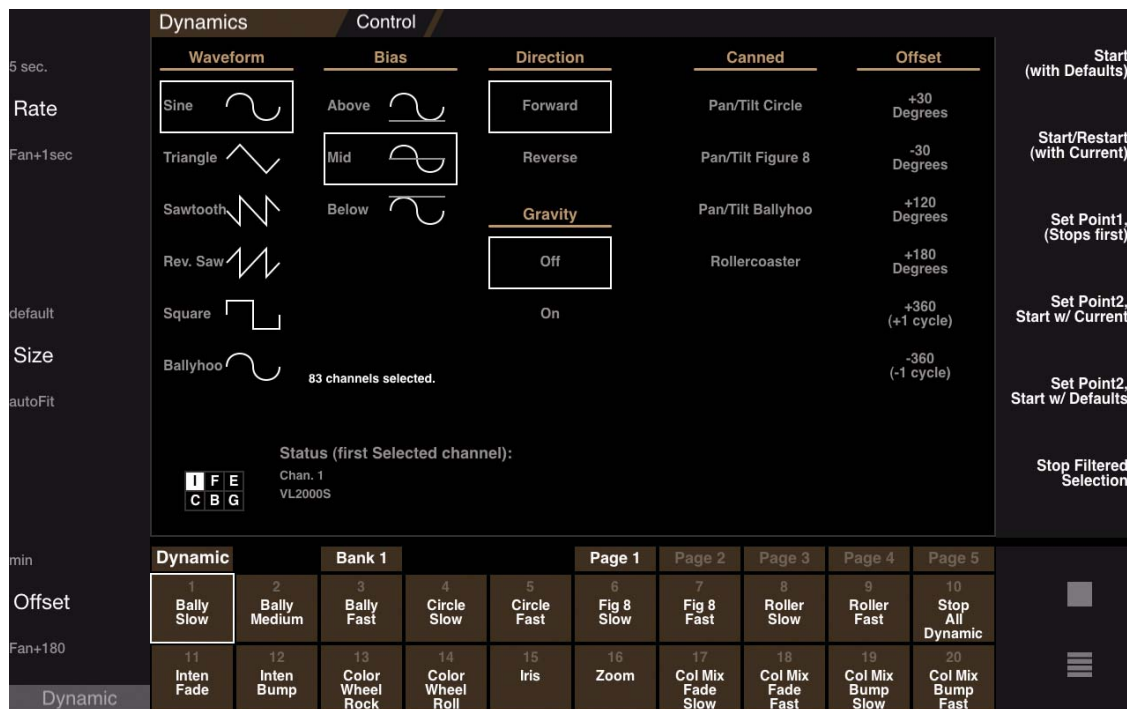

- Step 4. Open Function Filter by pressing "filter" in central touchscreen. (Refer to "Function Filter" on page 93.)
- Step 5. Select parameter(s).

**Tip** ⇨ Selected parameters will be displayed in the filter grid in the super palette.

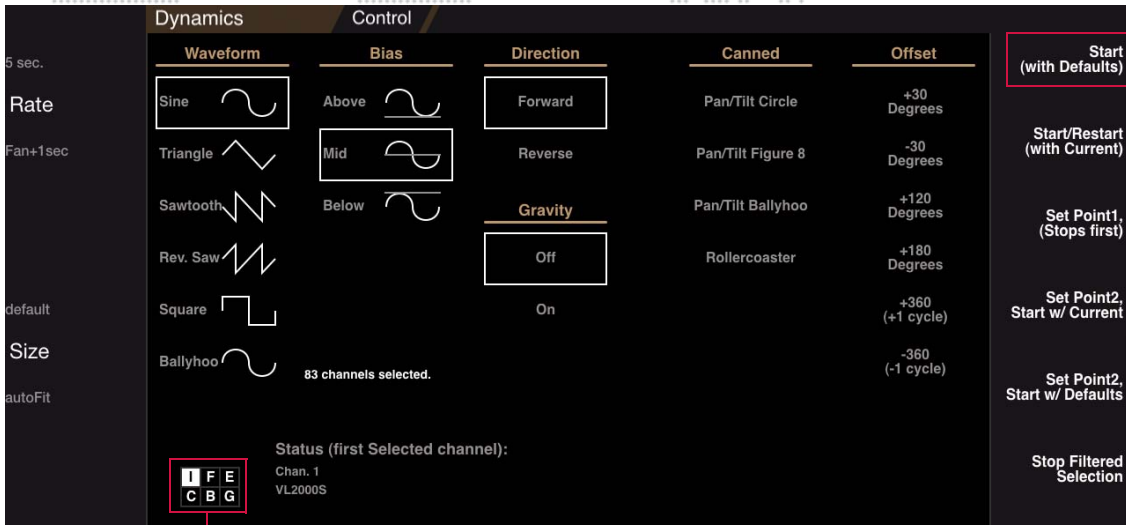

Function Filter			Wheel 2	Beam2	--	E Index	Timing		
			Wheel	Framing	--	Effect	Dynamic		
		--	Magenta	Strobe	--	Index	DynOnly		
Page 1			Tilt	Yellow	Zoom	Frost	R Gobo	Misc	
All		Inten	Pan	Cyan	Beam	Edge	Gobo	Sneak3D	
Clear		INTEN	FOCUS	COLOR	BEAM	EDGE	GOBO	TO CUE	
1	2	3	4	5	6	7	8	9	10
11	12	13	14	15	16	17	18	19	20

- Step 6. Press <Start with Defaults> button. The dynamic will be applied to selected channels.
- Step 7. Customize actions by selecting Waveform type, Bias, Direction, Gravity, Offset, etc.
- Step 8. At soft encoders, press [Dynam] button to map dynamic options to encoders. Adjust Rate, Size, and Offset by turning encoders. (Refer to "Using the Encoders with Dynamics" on page 157 for more information.)
- Step 9. Press and hold [Store] while pressing any open <Dynamic Select Button> to store.
- Step 10. Label dynamic. (When labeling, the name can be entered on the console touchscreen keyboard *or* computer keyboard.)
  - a. Press and hold [Label] while pressing <Dynamic Select Button>.
  - b. Enter alpha/numeric label.

### Playing Back a Custom Dynamic

Once created and stored into the Dynamics palette, custom dynamics can be easily recalled and applied to groups of luminaires. The procedure for playing back a custom dynamic is the same as playing back a canned dynamic. Refer to "Playing Back a Canned Dynamic" on page 155 for instructions.

## Dynamics with Keypad

Once stored, dynamics can also be recalled in the command line using the [Dynam] button.

*Example:*

[Group] [n] [Dynam] [m] [Enter] - applies Dynamic m to Group n (where m is the discrete dynamic number).

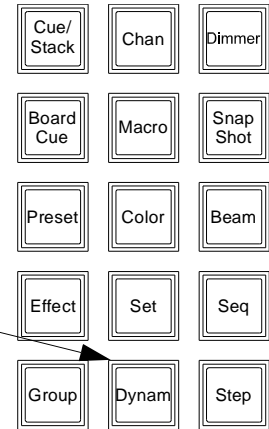

## Dynamics Palette Data Window

The Dynamics Palette Data window can be used to view, create and edit dynamics.

**Open Dynamics Palette Data window:**

- + At Data menu, select Dynamics Palette Data.

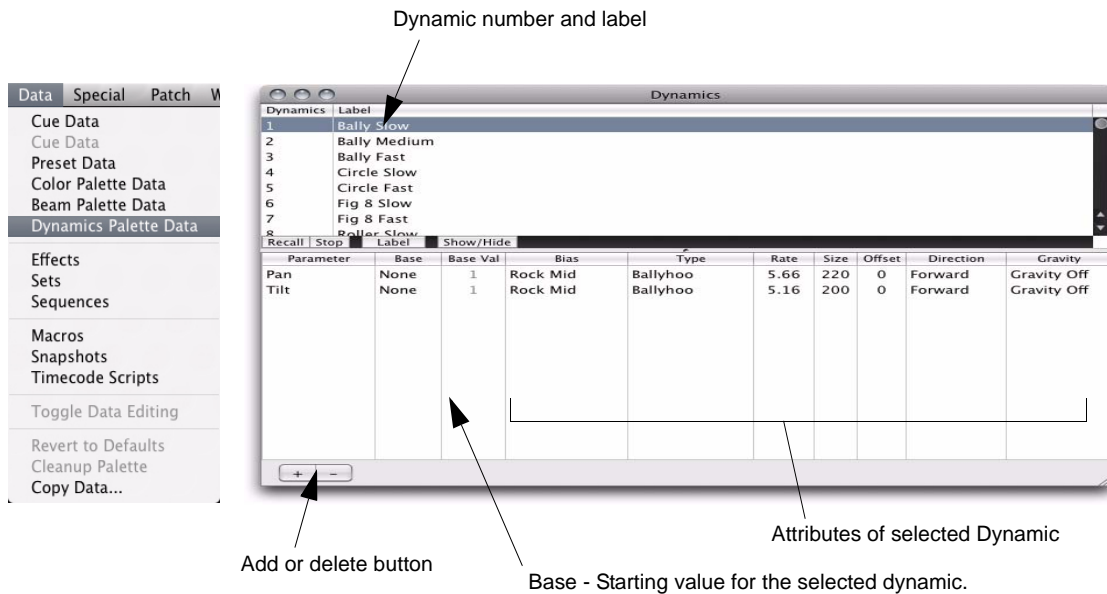



## Notes





## 8.

# EFFECTS

This chapter provides instructions for using the effects feature.

- + [EFFECTS OVERVIEW](#)
- + [CREATING EFFECTS](#)
- + [EFFECT ATTRIBUTES](#)
- + [EFFECT TIMING](#)
- + [PLAYING BACK EFFECTS](#)
- + [ADVANCED OPERATIONS](#)

## EFFECTS OVERVIEW

---

### What is an Effect?

An effect is a looping, wave, or ripple type operation which can be applied to multiple channels. Once created, an effect can be attached to a cue or played back directly in any submaster.

**Effects** are comprised of two components:

- 1) **Set** - The set is comprised of **parts** that define which channels are to be included in the effect playback, and in which order they will be addressed. Discrete channel numbers or channel ranges may be used to compose set parts with the limitation that a channel may only appear once within the set. Up to 2000 parts can be created within a single set.
- 2) **Sequence** - The sequence includes a number of **steps**, each of which define an action that an individual set part will perform. Discrete instructions, colors, beams, presets, and cues can be used to create a step. Up to 50 steps can be included within a sequence with each step having up to 3 action items.

The following diagram shows the components which make up a single effect:

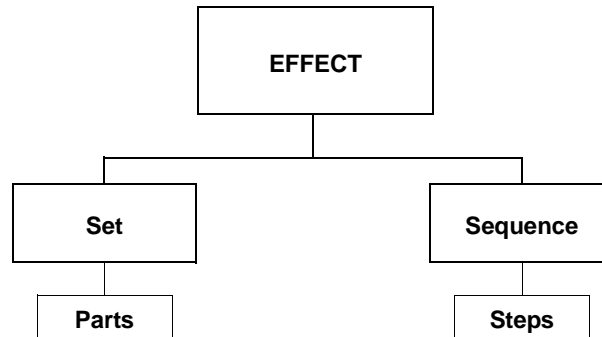

Start modes, timing and other parameters can also be built into an effect for further control.

## Effects Super Palette

Effects and effect components (including sets, sequences, parts, and steps) can be created using the Effects super palette. The Effects super palette is made up of all screens associated with creating or editing effects, including the Effect Edit, Set Edit, and Sequence Edit screens. The Effects super palette can be accessed at the palette displays available on the front panel (V476/V676 only) or via the Palette window (available from the **Operation** menu -- refer to "**Desktop Palettes Window**" on page 108).

**Note for V676 console users:** The Effects super palette can be accessed in any of the front panel touchscreen displays, however, it is recommended that it be used in one of the left displays so that the associated encoders may also be used.

**Effects Edit Screen (Main Screen)**

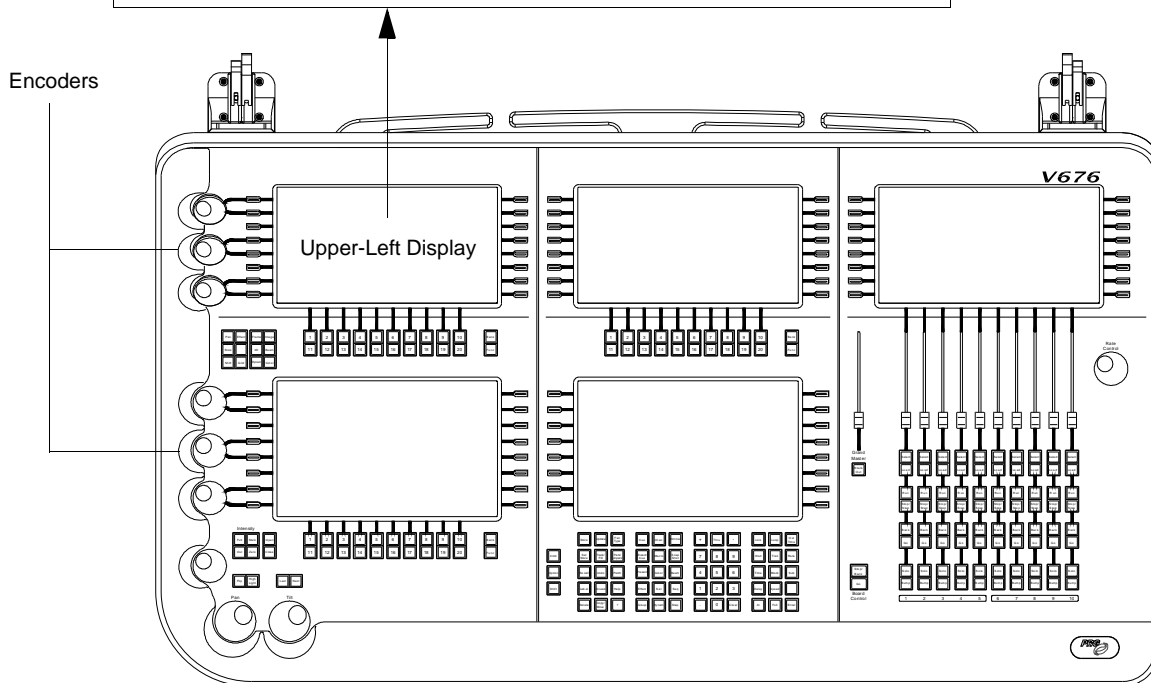

**Figure 8-1: Accessing Effects Super Palette on V676 Front Panel**

**Tip** ⇨ Press and hold keypad [?] button while clicking on any item on the screen to get help for that item.

A complete effect could be created using only the main Effect Edit screen, providing that it does not have more than seven parts to the set or more than seven steps in the sequence. If either the parts or steps exceed seven, then the Set Edit and Sequence Edit screen can also be used to create effects with numerous parts/steps. The appropriate use of each screen will be covered in the following sections.

Like other palette items (Color, Beam, Group, etc.) effects are given a discrete number. Once stored, they can be accessed in the command line or in the Effects palette. Refer to "[Front Panel Palette Displays \(V476/V676 Only\)](#)" on page 106 for more information.

Effect	Bank 1				Page 1	Page 2	Page 3	Page 4	Page 5
1 Magenta Amber Blue	2 Congo Yellow	3 Congo N/C Bounce	4 Green Red Bounce	5	6	7	8	9	10
11	12	13	14	15	16	17	18	19	20

## What is a Set?

A **set** consists of one or more **parts**. Parts are made up of specified channels (luminaire groups) with the limitation that a channel may only appear once within the set.

The following diagram shows an example set consisting of four parts:

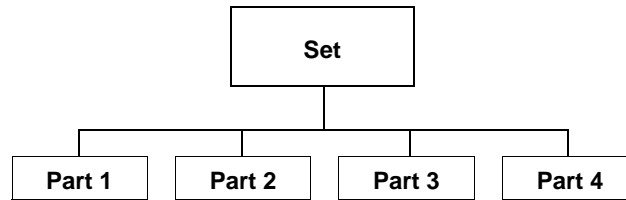

## Set 0 (Default Set)

One pre-programmed set is available, which contains all patched channels as a single part. This is the default set assumed by all effects unless changed. It can be used to quickly create an effect which would include all the luminaires in your system.

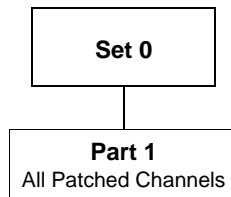

## What is a Sequence?

A **sequence** consists of one or more **steps**.

The following diagram shows an example sequence consisting of four steps:

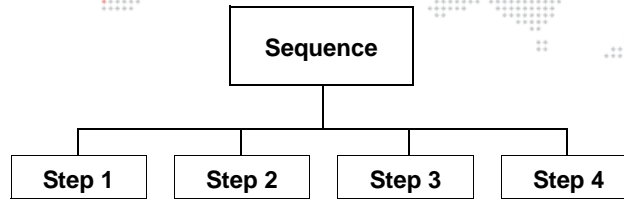

Steps may contain either a single cue, a cue range, or up to three action items in any combination of the following:

- + Beam
- + Color
- + Preset
- + Stop Flag
- + Any single parameter value

---

**Note:** If multiple steps include values for the same parameter, only the last action will be used.

---

# CREATING EFFECTS

## Creating a Basic Effect

This section provides instructions for creating a basic effect using the Effects Edit screen.

### To create a basic effect:

Step 1. At front panel, in upper-left display, bring up Effects palette. (Refer to "Effects Super Palette" on page 171 for additional information.)



Edit Icon -  
Press to open  
Effects Super Palette



Step 2. Press Edit icon to bring up Effects super palette. By default, the Effect Edit screen will be displayed first:



Step 3. At Effects palette, select a blank effect to be created. (A white box will appear around the selected item.)  
When a new effect is opened, the default numbers for the Set and Sequence will be the same as the chosen Effect number (unless already taken). For example, if Effect 5 is opened, the default Set and Sequence numbers will also be 5.

Set 0 (all patched channels) will be loaded into part 1 of the Set.

All attributes and timing will be in the default setting.

Step 4. Create a Set:

FadeIn	Set 1.	'VL5 All', 1 Parts, 12 Channels, exactly 12 channels per part.						Select Channels (no selected parts)	Interlaced	Set Channels
0.0	p1 71-82	p2	p3	p4	p5	p6	p7			

- Select required channels.
- Press  $\langle$ Interlaced/Sequential $\rangle$  button to select method of loading. (Also refer to "**Set: Interlaced vs. Sequential**" on page 176.)
- Press and hold [Set Channels] *or* [Store] while selecting first part (for example, p1), then while continuing to hold [Set Channels] / [Store], *drag* finger across touchscreen until last part is reached (for example, p6). Release [Set Channels] / [Store] button. This will specify the range of parts that will contain the channels. Channels will load across parts according to the method chosen (Interlaced or Sequential).

---

**Important!** In order to properly load the channels across the parts, you must *drag* your finger across the touchscreen. Pressing the first part button, then pressing the last part button will not work.

---

**Note:** Parts can be loaded in reverse order by *dragging* finger across the touchscreen in the *reverse direction*. For example, press and hold [Set Channels] *or* [Store] while selecting  $\langle$ p6 $\rangle$ , then while continuing to hold [Set Channels] / [Store], *drag* finger across touchscreen until  $\langle$ p1 $\rangle$  is reached. Release [Set Channels] / [Store] button.

---

**Note:** To create a Set with more than seven parts, it will be necessary to use the Set Edit screen. Refer to "**Using the Set Edit Screen**" on page 192.

---

Step 5. Create a Sequence:

	Seq 1.	'Mag Amber Blue', 3 Steps			Background State		Load Step
	1 Color P 2	2 Color P 3	3 Color P 4			Set Null (decay to previous)	

- Press [Load Step] button (at right of screen). (Button will flash and text will turn red.)
- Using palettes (Preset, Color, Beam, etc.) fill steps with actions. (Selection will automatically advance to the next step after an action is loaded.)

---

**Note:** Up to three actions can be stored in single step. To specify additional actions, select the step again and add the new action.

---

- Press [Cancel Load Step] button. (Button will stop flashing and text will turn to white.)
- If desired, select a Background State. (Refer to "**Sequence: Background State**" on page 177.)

---

**Note:** To create a Sequence with more than seven steps, it will be necessary to use the Sequence Edit screen. Refer to "**Using the Sequence Edit Screen**" on page 193.

---

Step 6. Label effect. (When labeling, the name can be entered on the console touchscreen keyboard *or* computer keyboard.)

- Press and hold [Label] while pressing  $\langle$ Effect Select Button $\rangle$ .
- Enter alpha/numeric label.

## Set: Interlaced vs. Sequential

When loading channels across two or more parts, the channels may be loaded "interlaced" or "sequentially."

*Channels loaded interlaced*

Set '6', 5 Parts, 10 Channels, exactly 2 channels per part. Selecting parts 1 through 5.									
p1 41, 46	p2 42, 47	p3 43, 48	p4 44, 49	p5 45, 50	p6	p7		Select Channels in Parts 1 through 5	Interlaced

*Channels loaded sequentially*

Set '5', 5 Parts, 10 Channels, exactly 2 channels per part. Selecting parts 1 through 5.									
p1 41-42	p2 43-44	p3 45-46	p4 47-48	p5 49-50	p6	p7		Select Channels in Parts 1 through 5	Sequential

### Change loading method:

- Step 1. At Effect Edit screen, press Sequential/Interlaced area to bring up options.
- Step 2. Choose Sequential or Interlaced.



## Sequence: Background State

Each sequence can contain one optional Background State. The Background State tells the luminaires where to go when not executing a step. If a Background State is not provided, and the behavior of the effect determines that it does not have an action at certain points during the effect, the luminaires will return to their state prior to being pulled into the effect. This default action is called a *Null State*. If a Background State has been defined, however, parts will run through each active step as determined by the distribution patterns for the effect and assume their Background State until a subsequent instruction is provided.



The Null State will return the luminaires to their previous state before the effect was started (for example, the previous cue recalled by the submaster). The Null State is primarily intended for use as an optional Background State, but can also be used as the action for any sequence step.

### Define a background state:

- Step 1. At Effect Edit screen, press Background State area to bring up options.
- Step 2. Choose a color, preset, beam, etc. as required, or specify as Null.

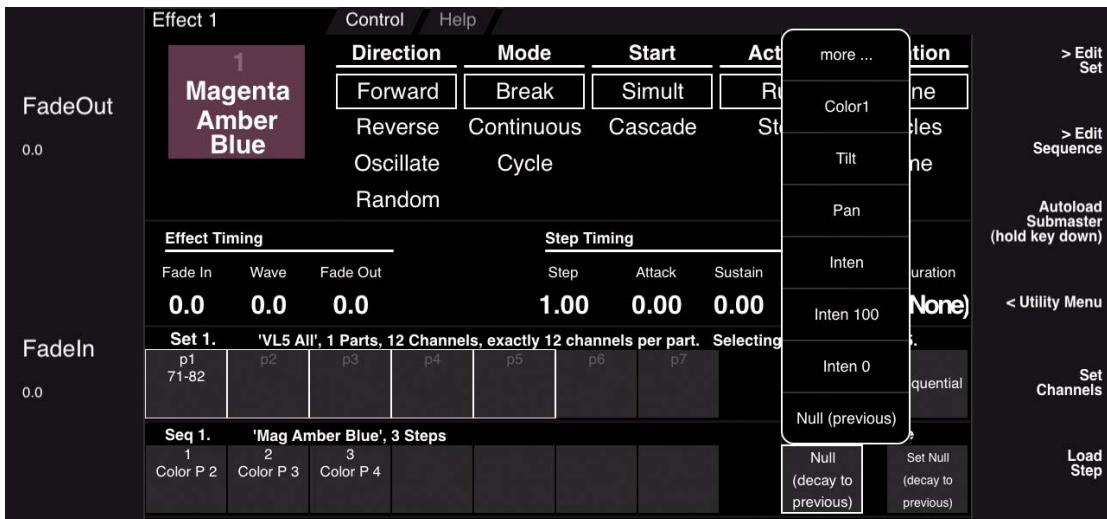

## Editing Effects

A store action will be required when making modifications to an existing effect. When changes are made, \*Mod\* will be displayed next to its number on the Effects Edit screen along with yellow text/boxes to indicate that a store action is necessary to save the changes.

**Important!** A modified effect could be loaded and played back in a submaster, but if it is not re-stored, all changes will be lost.

The screenshot shows the 'Effects Edit' interface for 'Effect 1'. A red circle highlights a warning: '1 \*Mod\* Magenta Amber Blue. Unsaved changes. Hold <Store> and touch the button above to save.' The interface includes sections for 'Direction' (Forward, Reverse, Oscillate, Random), 'Mode' (Break, Continuous, Cycle), 'Start' (Simult, Cascade), 'Action' (Run, Stop), and 'Duration' (None, Cycles, Time). It also features 'Effect Timing' (Fade In, Wave, Fade Out) and 'Step Timing' (Step, Attack, Sustain, Decay, Null, Duration) sections. A 'Set 1.' section shows 'VL5 All, 1 Parts, 12 Channels, exactly 12 channels per part. Selecting parts 1 through 5.' with a grid of parts (p1-p7) and a 'Sequential' option. A 'Seq 1.' section shows 'Mag Amber Blue', 3 Steps (Color P 2, Color P 3, Color P 4) and a 'Background State' section with 'Null (decay to previous)' and 'Set Null (decay to previous)' options. On the right side, there are buttons for '> Edit Set', '> Edit Sequence', 'Autoload Submaster (hold key down)', '< Utility Menu', 'Set Channels', and 'Load Step'.

### To edit an effect:

- Step 1. At Effects palette, select effect. (A white box will appear around the selected item.)
- Step 2. Make changes as required.
- Step 3. Press and hold [Store] while pressing (Effect Select Button) to store changes.

### Keypad shortcuts:

- + Press and hold [Delete] to clear either a sequence step or a set part.
- + Press and hold [Copy/Move] to copy sequence steps or set parts.
- + Double-click and hold [Copy/Move] to shift all sequence steps or set parts.
- + Double-click and hold [Copy/Move] to insert/remove sequence steps or set parts.
- + Using [Group] with a set part will select channels in the part as an Ad Hoc Group.
- + Using [Group] with any effect in the Effects palette will select ALL channels in the effects' set as an Ad Hoc Group.

# EFFECT ATTRIBUTES

## Overview

The Direction, Mode, Start, Action and Duration attributes provide overall control of an effect's behavior when played back.

- + **Direction / Mode / Start** - determines how the sequence steps are applied to the set parts. (These attributes are used in combination to provide different executions of set parts.)
- + **Action** - determines how an effect will behave when loaded into a submaster.
- + **Duration** - determines how long an effect will run.

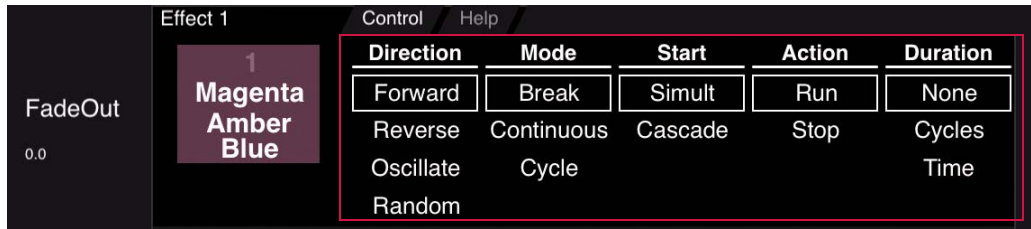

## Direction

Direction determines which direction the sequence steps will run.

**Forward** - The sequence steps will run forward (Step 1, Step 2, Step 3, etc.) and then start over when the last step is reached.

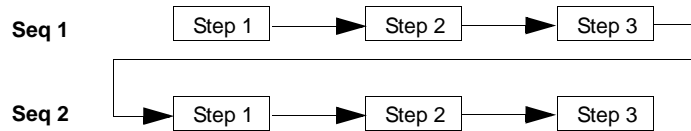

**Reverse** - The sequence steps will run backward (Step 3, Step 2, Step 1) and then start over when the first step is reached.

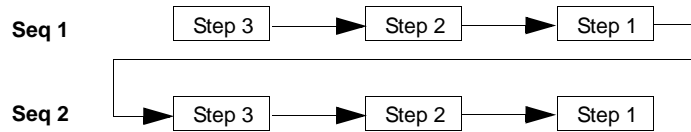

**Oscillate** - The sequence steps will run forward, then in a reverse direction, forward, then reverse, etc.

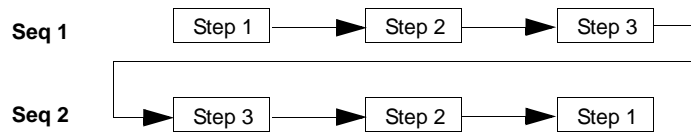

**Random** - The console chooses which sequence steps to run, in what order, and the timing used.

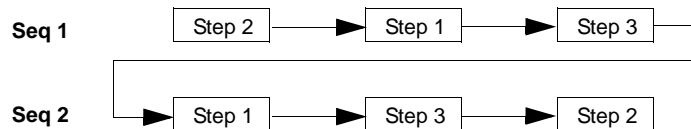

## Mode

Mode determines how the sequence steps will run in relationship to each other.

- + **Break** - Each part makes one pass through each step on any individual cycle and then goes to its background state when not in a step.

*Breaking/Cascade Effect:*

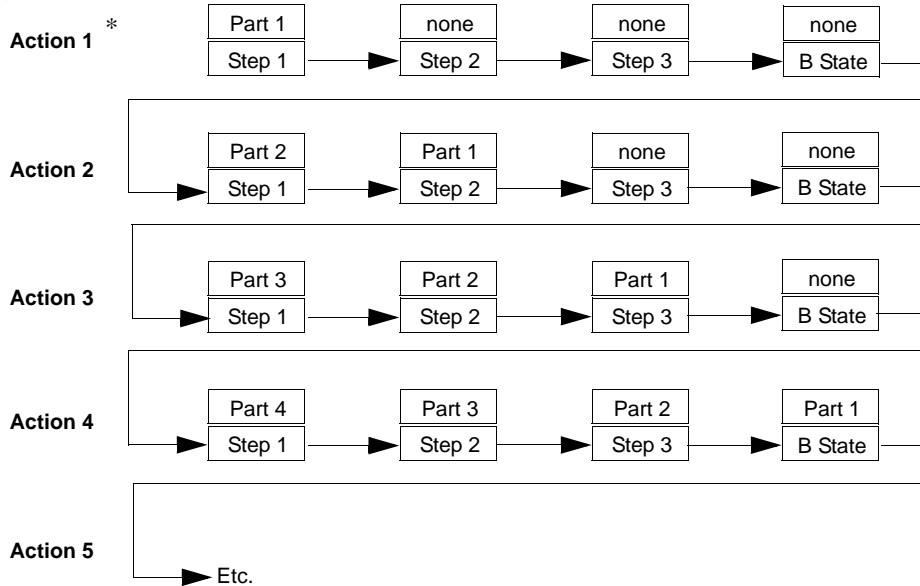

\* For example purposes, actions are not necessarily complete sequences. An action merely represents what happens at each stage of the effect whether it is a complete sequence or a portion of a sequence.

- + **Continuous** - Once started, all parts are in some step at all times during the effect. Once a part reaches the last step, it automatically goes back to the first step and repeats sequence. (Refer to the example diagram on next page.)
- + **Cycle** - The effect runs all set parts through the first sequence step, then each set part through the second sequence step, etc.

## Start

Start determines how the sequence steps will enter the effect.

- + **Simultaneous (Simult)** - All set parts assume some effect state upon effect recall (either a discrete instruction or the background state).
- + **Cascade** - The set parts will start the sequence in a staggered entry. Part 1 will complete Step 1, then go to Step 2, while Part 2 begins Step 1, etc.

*Continuous/Simultaneous Effect:*

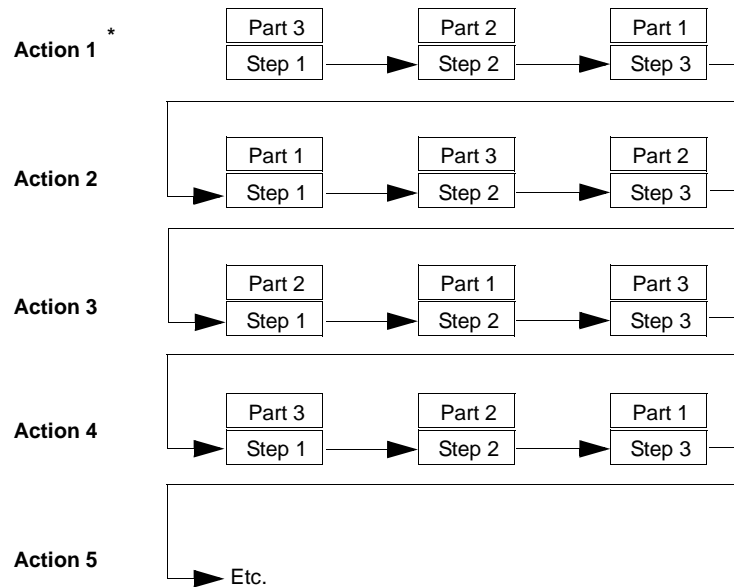

\* For example purposes, actions are not necessarily complete sequences. An action merely represents what happens at each stage of the effect whether it is a complete sequence or a portion of a sequence.

## Action

Action determines how an effect will behave when loaded into a submaster.

- + **Run** - By default, the effect will load into the submaster in the Run state. In this case, the effect will automatically begin running once it is loaded.
- + **Stop** - By default, the effect will load into the submaster in the Stop/Step state. Press [Stop/Step] to trigger playback. (This can be useful if manual execution is required for an effect.)

## Duration

Duration determines how long an effect will run.

- + **None** - The effect will run infinitely until manually stopped.
- + **Cycles** - The effect will run a specified number of times (cycles) then stop. It will then await manual restart or go to the next event.
- + **Time** - The effect will run a specified length of time before fading out. In this case, the intensity will fade out in the time specified by the Fade Out time. Note that only effects which have *intensity* included, will respond to this value. In addition, if another submaster has intensity for those channels, Highest Takes Precedence rules apply. Refer to "**HTP (Highest Takes Precedence)**" on page 301.)

## Changing Effect Attributes

Attributes are specified at the main Effect Edit screen:



### Change effect attributes:

- Step 1. At Effects palette, select an effect to be edited. (A white box will appear around the selected item.)
- Step 2. Change attributes by touching Forward, Reverse, Oscillate, Random, etc. (A yellow box will appear around the newly selected item.)
- Step 3. Press and hold [Store] while pressing <Effect Select Button> to store changes.

# EFFECT TIMING

## Overview

Timing values can be applied to the overall effect and/or to a single sequence step in order to specify the length of time any given attribute will execute. Timing controls include:

- + **Effect-Level Timing** - Fade In, Fade Out, Wave, and Duration.
- + **Step-Level Timing** - Step, Attack, Sustain, and Decay.

The following diagram shows an example relationship of timing parameters:

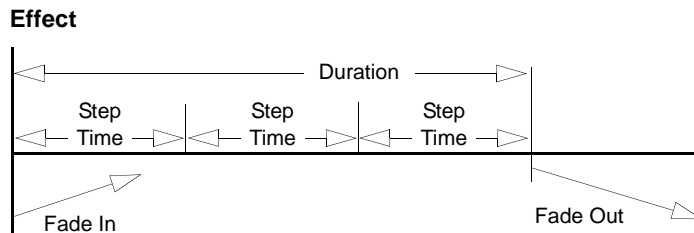

## Effect-Level Timing

Timing can be programmed on an effect level to control the fade in/out times, wave time, and duration of the overall time or cycles.

- + **Fade In** (0 - 59.59) - Allows channels to begin the effect sequence while fading to the full intensity value required by the effect steps. (If there is no fade in time, the effect will follow the attack time in the sequence.)
- + **Fade Out** (0 - 59.59) - Allows channels to fade out after exiting the effect. This timing value is only assumed by channels that are going inactive in the incoming cue, or when the cycle or duration time has expired. Any channels involved in the incoming cue would immediately cease activation in the effect and fade to their new cue levels in the time provided by the incoming cue. If there is no Fade Out Time, all channels will immediately stop the effect pattern and fade to their new instructions in the time dictated by the incoming cue. If they are not involved in the incoming cue, they will fade to inactive in the out time of the incoming cue.
- + **Wave** - The time it will take an effect to loop back to the beginning. (Only applies to Break or Cycle modes.) A wave time can only be greater than the total sequence time (i.e., the Wave time will never cut a sequence short, only add a gap before the sequence starts again).

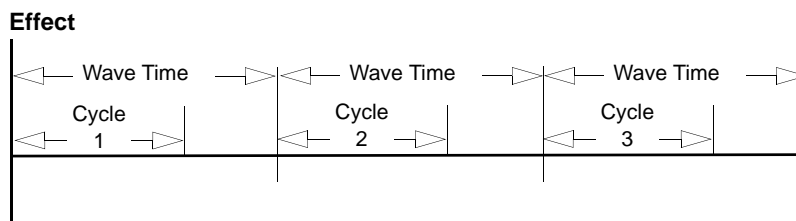

- + **Duration** - Depending on whether *Time* or *Cycles* is selected as the effect Duration attribute (see "**Duration**" on page 182), this value will be defined differently:

When *Cycles* is selected, this number will specify how many times the set will run through the sequence before stopping. After running the specified number of times, the effect will stop and await manual restarting or go to the next event.





## Step-Level Timing

Timing can be programmed on a sequence step-level to control the step, attack, sustain, and decay for each step in the sequence.

---

**Note:** When cues are included in sequences, the cue times will override step attack times, unless timing is disabled by the Function Filter. (Refer to "**Function Filter**" on page 93.)

---

- + **Step** - The time between activation of a step and the next sequential step. This can also be controlled on a universal level in the effects timing attributes (refer to "**Effect-Level Timing**" on page 183).
- + **Attack** - Transition time between current luminaire state and state dictated by the step action.
- + **Sustain** - How long the channels will execute the action.
- + **Decay** - Transition time out of a step into a background state. This is used only in a situation where the effect is in Break mode and the attack and sustain times are longer than the total step time.

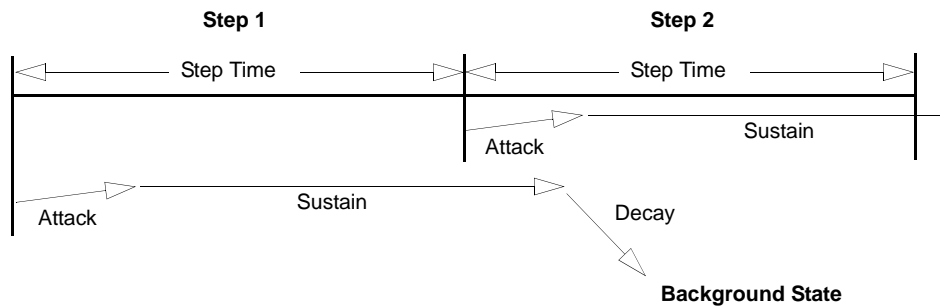

## Assigning Timing Values

Timing values are specified at the main Effect Edit screen:



When [Effect] is selected at the soft encoders, the encoders will be mapped so they can be used to adjust timing values. Mapping is as follows:

- — **Fade Out** (effect)
- — **Fade In** (effect)
- — **Decay** (step)
- — **Sustain** (step)
- — **Attack** (step)
- — **Step** (step)

Pressing [Shift] while using an encoder allows step times to be set for individual steps.

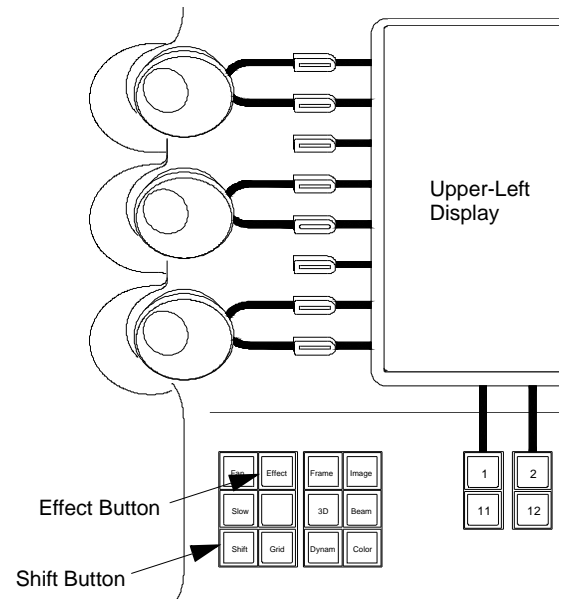

**Note:** The Effects super palette can be accessed in any of the front panel touchscreen displays, however, it is recommended that it be used in the upper-left display so that these encoders may be used.

**Note:** The V676 console is shown in this example, however, these buttons are found on all Vx76 console front panels.

Figure 8-2: Shift/Effect Button

**Assign effect timing using encoders:**

Step 1. At Effects palette, select an effect to be edited. (A white box will appear around the selected item.)

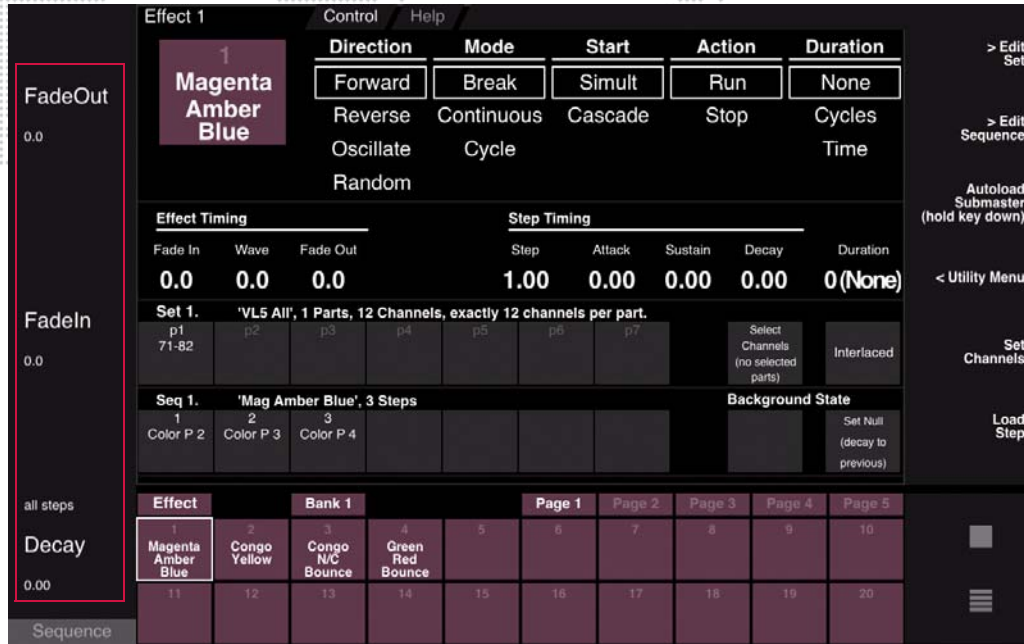

Step 2. Using encoders, set times as required.

---

**Note:** When setting step times, the default is to change all steps globally. To set step times for individual steps, first select the step, then press and hold [Shift] while using the encoder.

---

Step 3. Press and hold [Store] while pressing (Effect Select Button) to store changes.

**Assign effect or step timing using numeric entry:**

- Step 1. At Effects palette, select an effect to be edited. (A white box will appear around the selected item.)
- Step 2. At Effect Edit screen, press any timing field area. Set timing values using pop-up numeric keypad.



- Step 3. Press and hold [Store] while pressing <Effect Select Button> to store changes.

**Assign step timing using tap-sync:**

Step time can also be set using the "tap-sync" method.

- + Hold Cmd and repeatedly tap the Stop/Step button a few times at the desired rate on a submaster while running an effect (refer to "Basic Playback" on page 189 for more information about playback). The average tap time, entered while the Cmd key is held down, will be applied live and stored to the effect.

A new tap sync average is calculated each time the Cmd key is held while tapping the Stop/Step button.

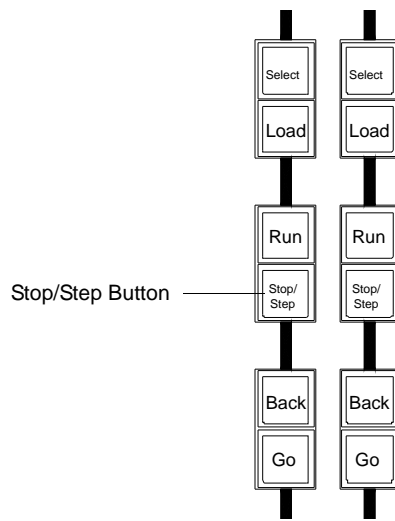

# PLAYING BACK EFFECTS

## Basic Playback

After creating an effect, it can be played back using a submaster. (If a duration or cycle count is not specified, the effect will run until stopped.)

### Play an effect:

- Step 1. At keypad, press [Effect] [n] [Enter] - where n is the desired effect number. (It will be displayed by number and label in command-line display.)
- Step 2. At desired submaster, press [Select].
- Step 3. Press [Load] to place effect in submaster's pending file.
- Step 4. Ensure Grand Master fader is set at full.
- Step 5. Ensure submaster fader is 100%.
- Step 6. Press [Go] to play effect. Display will indicate set, sequence, and step numbers as they run.
- Step 7. Press [Run] to replay effect once it is active.

### Play next effect:

The submaster always sequences, placing the next available effect in the pending file.

- + Press [Go] to play back pending effect.

### Play previous effect:

The submaster can play back previously played effects in decrementing order.

- + Press [Back] to play previous effect.

**Note:** The V276 front panel does not include the [Run], [Stop], and [Step] buttons. Perform these actions using the alternate button combinations, as given below, or use the Submaster HUD.

### Play active effect again:

- + V476/V676: Press [Run]
- + V276: Press [Cmd] / [Back]

### Stop a running cue / step through cues:

A running effect can be stopped and then stepped through one step at a time.

- + V476/V676: Press [Stop/Step]
- + V276: Press [Cmd] / [Go]

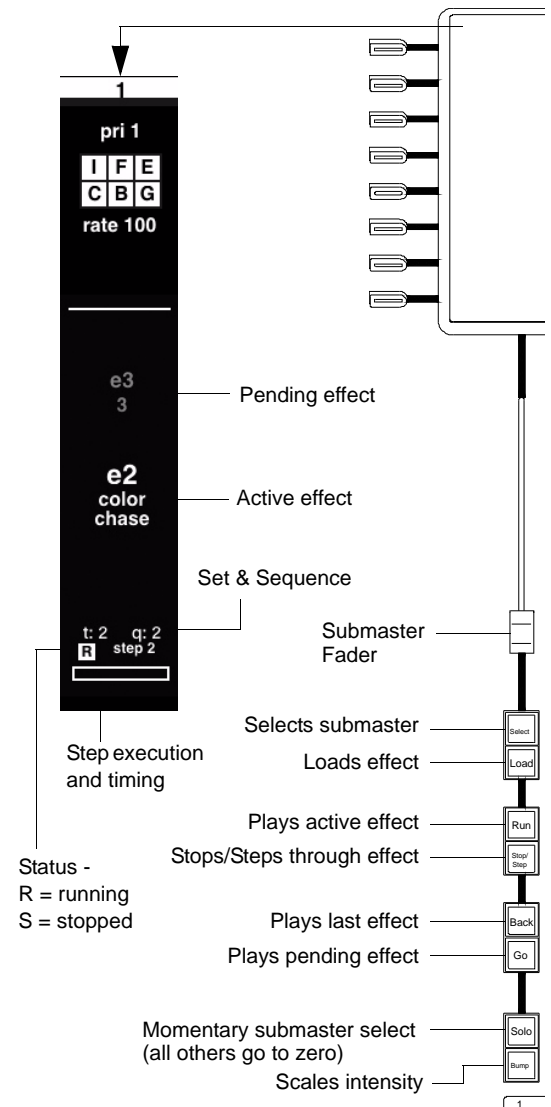

## Autoload Submaster

The Effects super palette can be placed in Autoload mode for automatic submaster loading. Once in Autoload mode, when an effect, set, or sequence is selected at the Effects select display, it will automatically load into the specified submaster.

### To set Autoload Submaster mode:

- + At Effect Edit screen, press and hold [Autoload Submaster] button while choosing a submaster. ("Choose" is activated by touching the specific submaster on the touchscreen.)

Effect 1 Control Help

Direction	Mode	Start	Action	Duration
Forward	Break	Simult	Run	None
Reverse	Continuous	Cascade	Stop	Cycles
Oscillate	Cycle			Time
Random				

Effect Timing Step Timing

Fade In	Wave	Fade Out	Step	Attack	Sustain	Decay	Duration
0.0	0.0	0.0	1.00	0.00	0.00	0.00	0 (None)

Set 1. 'VL5 All', 1 Parts, 12 Channels, exactly 12 channels per part.

p1	p2	p3	p4	p5	p6	p7
71-82						

Seq 1. 'Mag Amber Blue', 3 Steps

1	2	3
Color P 2	Color P 3	Color P 4

Background State

Effect	Bank 1	Page 1	Page 2	Page 3	Page 4	Page 5
Magenta Amber Blue	Congo Yellow	Congo N/C Bounce	Green Red Bounce			

Submaster Setup

Pri 1 0

1	2	3	4	5	6	7	8	9	10
IFE C B G rate 100	IFE C B G rate 100	IFE C B G rate 100	IFE C B G rate 100	IFE C B G rate 100	IFE C B G rate 100	IFE C B G rate 100	IFE C B G rate 100	IFE C B G rate 100	IFE C B G rate 100

Press the area below a submaster's number to "choose" the submaster

- + To release a submaster from Autoload mode, press and hold [Autoload Submaster] button while touching submaster "choose" area again. (The function toggles on and off.)

## Stop Flags

Steps can contain "stop flags" which will cause the effect to pause when that step is reached during playback. Once paused, the submaster will switch from the Run mode to the Stop/Step mode. The effect will resume playback when [Run] is pressed again.

### Add stop flag to a step:

- Step 1. At Effects super palette, select an effect to be edited. (A white box will appear around the selected item.)
- Step 2. Double-click any <Sequence Step Button> to bring up options.
- Step 3. Select "set stop flag".
- Step 4. Press and hold [Store] while pressing <Effect Select Button> to store changes.

The screenshot shows the software interface with a context menu open over a step. The menu options include: more ..., Color1, Tilt, Pan, Inten, Inten 100, Inten 0, and set stop flag. The background shows various effect controls like FadeOut, FadeIn, and Decay, along with a sequence grid at the bottom.

# ADVANCED OPERATIONS

## Using the Set Edit Screen

The Set Edit screen can also be used to create and edit set parts. This screen displays up to 50 parts at a time, and will be necessary to use when any Set requires more than seven parts (since the Effect Edit screen will display a maximum of seven parts).

### To open:

- + At Effect Edit screen, press [Edit Set] button.



An Effect Set palette is provided at the bottom of the screen, which provides access to all stored sets. When a set is selected in the palette, its parts will be displayed at the top of the screen. Sets can be created and edited here using the same operations as on the Effect Edit screen. Refer to "Creating a Basic Effect" on page 174 and "Editing Effects" on page 178 for instructions.

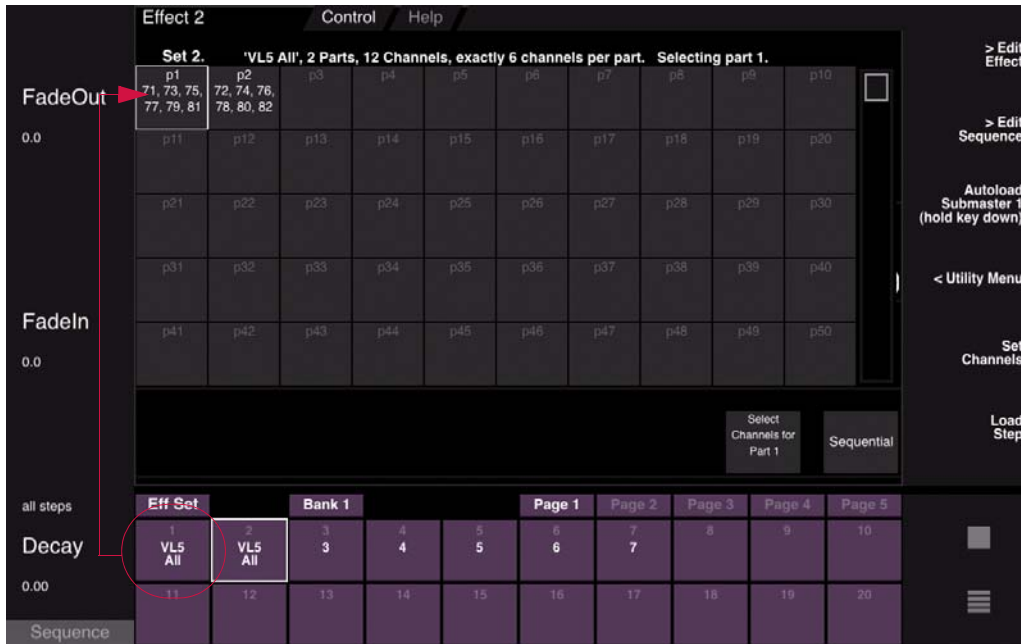

By using the Set Edit screen, it is possible to create sets *before* they are actually stored into an effect. This can be useful if pre-programming is required.



## Using the Sequence Edit Screen

The Sequence Edit screen can also be used to create and edit sequence steps. This screen displays up to 50 steps at a time, and will be necessary to use when any sequence requires more than seven steps (since the Effect Edit screen will display a maximum of seven steps).

### To open:

- + At Effect Edit screen, press [Edit Sequence] button.



An Effect Sequence palette is provided at the bottom of the screen, which provides access to all stored sequences. When a sequence is selected in the palette, its steps will be displayed at the top of the screen. Sequences can be created and edited here using the same operations as on the Effect Edit screen. Refer to "Creating a Basic Effect" on page 174 and "Editing Effects" on page 178 for instructions.



By using the Sequence Edit screen, it is possible to create sequences *before* they are actually stored into an effect. This can be useful if pre-programming is required.

## Creating Effects Using Set/Sequence Edit Screens

If sets and sequences are pre-stored, an effect can be created at a later time using the Effect Edit screen.

### Create an effect using Set/Sequence Edit screens:

- Step 1. Press [Edit Set] button to open Edit Set screen.
- Step 2. At palette, select required set.
- Step 3. Press [Edit Sequence] button to open Edit Sequence screen.
- Step 4. At palette, select required sequence.
- Step 5. Press [Edit Effect] to return to main Effect Edit screen.
- Step 6. Press and hold [Store] while pressing (Effect Select Button). This will store the set and sequence selections into that effect number.

### Groups as Effect Sets

A Group can be used as a Set within an effect.

#### Guidelines:

- + Groups must be chosen from the 20-up palette in the Effects screen.
- + How a group is arranged determines the parts of the effect, e.g. a group with an arrangement of 2 divisions with 5 channels in each division will transfer to the effect as 2 parts with 5 channels each.

#### To specify a group as a set:

- Step 1. At Effects super palette, access Group palette.
- Step 2. Select a group. (The chosen group will be associated with the effect instead of a set.)

The screenshot displays the 'Effect 1' control screen. At the top, there are tabs for 'Effect 1', 'Control', and 'Help'. The main area is divided into several sections:

- Effect Name:** 1 BB / 3K ALL STROBE
- Direction:** Forward, Reverse, Oscillate, Random
- Mode:** Break, Continuous, Cycle
- Start:** Simult, Cascade
- Action:** Run, Stop
- Duration:** None, Cycles, Time
- Effect Timing:** Fade In (0.0), Wave (0.0), Fade Out (0.0)
- Step Timing:** Step (0.0), Attack (0.0), Sustain (0.0), Decay (0.0), Duration (0 (None))
- Set 1:** 'BB / 3K ALL', 1 Parts, 111 Channels, exactly 111 channels per part. Selecting parts 1 through 6. Includes a table for parts p1 through p7 and an 'Interlaced' checkbox.
- Sequence:** '1', 0 Steps
- Background State:** Set Null (decay to previous)
- Group Palette:** A grid of 20 groups. Group 1 is selected. The groups are: 1 (ALL), 2 (BEST BOY), 3 (VL3K), 4 (VL3500 SPOT), 5 (3500 FX), 6 (3500 WASH), 7 (MAC 2K), 8 (SHARPY), 9 (VL5), 10 (LED PAR), 11 (13 copy), 12 (11 copy), 13 (12 copy), 14, 15, 16, 17, 18, 19, 20.

On the right side, there are several buttons: '> Edit Set', '> Edit Sequence', 'Autoload Submaster', '< Utility Menu', 'Set Channels', and 'Load Step'.

The command line can also be used to associate a group to an effect using the syntax: [Effect] # [Group] # [Enter].

**To edit a group set:**

Groups can be edited while associated to an effect.

Once a group is selected in the super palette, the <Set Channels> button will disappear and the <Edit Set> button will change to <Edit Group>. Pressing <Edit Group> will navigate to the group super palette where the arrangement can be changed. The [Edit Effect] button, located above the pile-on button, can be used to navigate back to the effect super palette.

The screenshot displays the software's control interface for editing effect groups. At the top, there are tabs for 'Effect 13', 'Control', and 'Help'. The main area is divided into several sections:

- Effect 13 Settings:** Includes a 'Direction' table (Forward, Reverse, Oscillate, Random), a 'Mode' table (Break, Continuous, Cycle), a 'Start' table (Simult, Cascade), an 'Action' table (Run, Stop), and a 'Duration' table (None, Cycles, Time). A note indicates 'Unsaved changes. Hold <Store> and touch the button above to save.'
- Effect Timing:** Features 'Fade In', 'Wave', and 'Fade Out' controls, all set to 0.0.
- Step Timing:** Features 'Step', 'Attack', 'Sustain', 'Decay', and 'Duration' controls, all set to 0.0.
- Group 2 Details:** Shows 'BEST BOY', 12 Parts, 12 Channels, exactly 1 channels per part. It includes a 'Select Channels in Parts 1 through 6' button and an 'Interlaced' checkbox.
- Seq 13:** Shows '0 Steps' and a 'Background State' section with a 'Set Null (decay to previous)' button.
- Group Palette:** A grid of effect names including 'BEST BOY', 'VL3K', 'VL3500 SPOT', '3500 FX', '3500 WASH', 'MAC 2K', 'SHARPY', 'VL5', and 'LED PAR'. The 'BEST BOY' group is currently selected.
- Right Side Panel:** Contains buttons for '> Edit Group' (highlighted with a red circle), '> Edit Sequence', 'Autoload Submaster', '< Utility Menu', and 'Load Step'.

**Creating Effects From the Command-Line**

If sets and sequences are pre-stored, an effect can be created at a later time using the command line.

**Create/store an effect using the command line:**

- + Press [Effect] [n] [Set] [n] [Seq] [n] [Enter] - defines set and sequence for Effect n.
- + Press [Store] [Effect] [n] to store changes to an effect.

## Storing Effects as Cues

An effect can also be attached to a cue using the Link feature. When linked, the effect will appear in the Cue Sheet Link column. This "effect cue" will behave just as any other standard cue and will allow other parameters or advanced attributes to be stored along with the effect. Refer to "Link" on page 250 for more information.

Recalling an effect cue does a normal cue recall for the cue data and then executes the effect. The cue data can place channels in a desired state before the effect starts running.

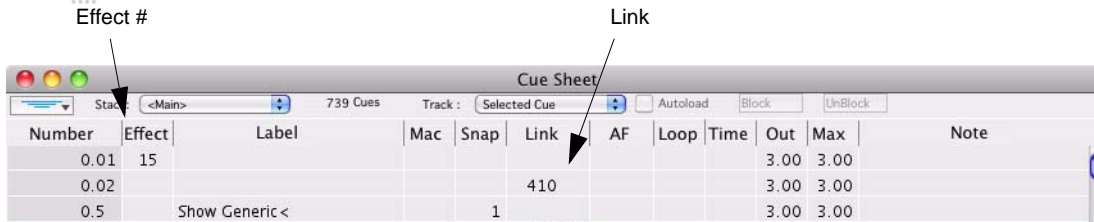

### Link an effect to a cue:

- + [Store] <Cue> [n] [Link] [Effect] [x] [Enter] - stores effect x into the specified cue number n. (Current stage look is not included.)

### Link an effect to a cue and label:

When labeling, the name can be entered on the console touchscreen keyboard *or* computer keyboard.

- + [Store] <Cue> [n] [Link] [Effect] [x] [Label] <xxxxxx> <Enter/Accept>.

## Utility Menu

The Utility Menu can be used for advanced selection of active set parts and for erasing set parts and sequence steps.

### To use the menu:

- Step 1. At Effect Edit screen, select required effect.
- Step 2. Press [Utility Menu] button.
- Step 3. Choose an option by touching.
- Step 4. Confirm or reject warning dialog.

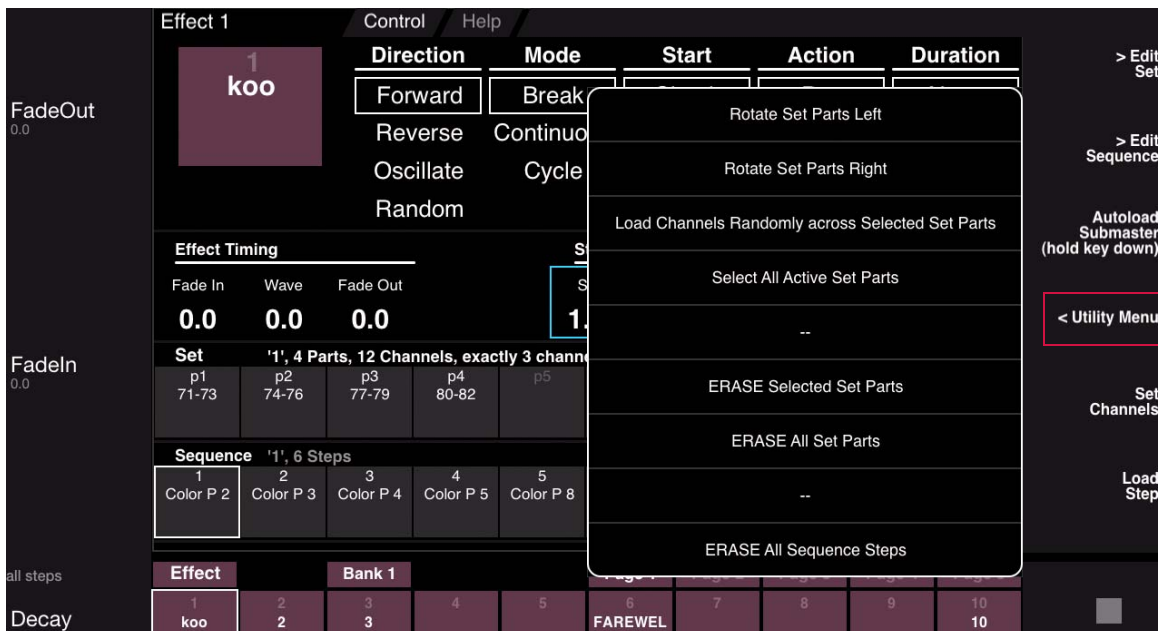



## 9.

# SPECIAL FEATURES

This chapter contains instructions for controlling luminaires and media servers with the console's advanced features, and for copying and moving programmed data.

- + **ADVANCED CONTROL**
- + **DATA COPY AND MOVE**
- + **FUNCTION KEYS**
- + **CONTROLLING MEDIA SERVERS**

# ADVANCED CONTROL

## Manual Timing

The Manual Timing feature is used to apply parameter times manually. While Manual Timing is active, any manual changes via the palettes or the encoder buttons will follow the timing currently active in the luminaire. (Manual Timing is an alternate control state. It will be active until de-selected.)

### Activate Manual Timing using front panel button:

- Step 1. At front panel, press [Manual Timing] toggle button (button will flash).
- Step 2. Press button again to deactivate mode.

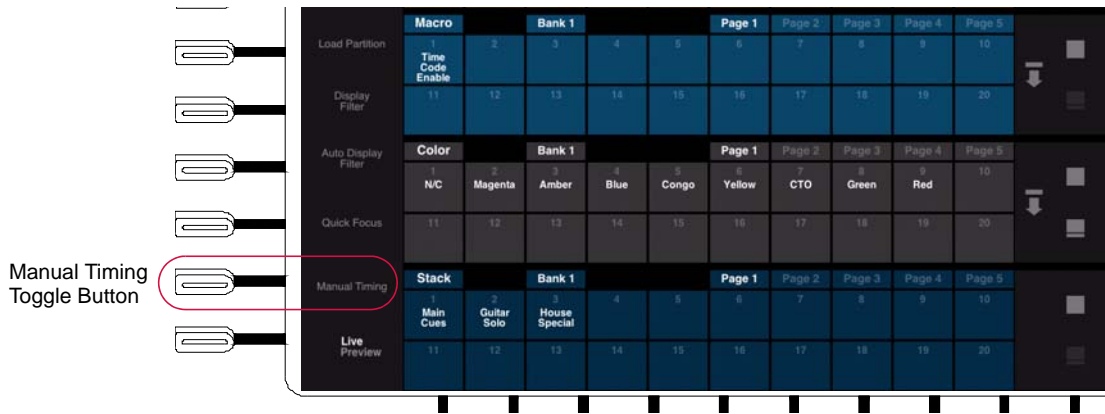

### Activate Manual Timing using Timing Filter:

- Step 1. At Timing Filter, press (Manual Time) button.
- Step 2. Press button again to deactivate mode.

⊗ ⊕			1.00	--	--	--	--
Timing Filter			1.00	Framing	--	--	--
Manual Time		--	Magenta 1.00	--	--	--	--
Page 1	Up	Tilt 5.00	Yellow 1.00	--	--	--	--
All	Down	Pan	Cyan 1.00	--	Edge	--	--
Clear	INTEN	FOCUS	COLOR	BEAM	EDGE	GOBO	ENTER

### Activate Manual Timing using menu:

- Step 1. At Special menu, select Manual Timing.
- Step 2. Select Manual Timing again to deactivate mode.

Special	Patch	Window	Info
Task Progress			⌘ T
Clear Status Errors			
Enable Remote Focus Control			
Park			
UnPark			
Select Parked			
Encoder Fan			▶
QuickFocus			⌘ F
Highlight			
Select			▶
Manual Timing			▶
Status			▶

## QuickFocus

The QuickFocus feature allows you to step sequentially through each stored channel in a selected preset to adjust its parameters. The new parameter data can then be stored into the preset. This allows you to easily isolate data so that it can be updated without affecting the remaining data in your preset.

QuickFocus is an alternate control state. It will be active until de-selected.

### Guidelines:

- + During QuickFocus, the entire preset is brought up live and all other outputs are disabled (as long as the console is still in QuickFocus mode).
- + QuickFocus is affected by its configuration in the System Settings window. When the "Select Only Referenced Channels" option is checked, only channels that are referenced in cues or effects will be selected while using QuickFocus. (For more information about the Setting window, refer to "[Settings Window](#)" on page 306.)



### Update a preset with QuickFocus:

- Step 1. At front panel, press [QuickFocus] toggle button (button will flash) *or* at **Special** menu, select **QuickFocus**. Console will assume QuickFocus mode.
- Step 2. Select required preset by using preset select or keypad. All luminaires that have data from that preset will be selected and will bring up the preset live.
- Step 3. Press [Next]\*. First channel will stay active, while all other channels go to inactive state.
- Step 4. Modify focus or other parameters as required.
- Step 5. Press [Next]\* to go to next channel. When the last channel with stored information has been brought up and adjusted, pressing the [Next]\* button activates the entire modified preset.
- Step 6. Re-store preset to save changes using Update, Selective Store or standard Store commands.
- Step 7. Press [QuickFocus] toggle button again to deactivate mode.

Special	Patch	Window	Info
Task Progress			⌘ #T
Clear Status Errors			
Enable Remote Focus Control			
Park			
UnPark			
Select Parked			
Encoder Fan			▶
QuickFocus			#F
Highlight			
Select			▶

\* Or [Last] as required.

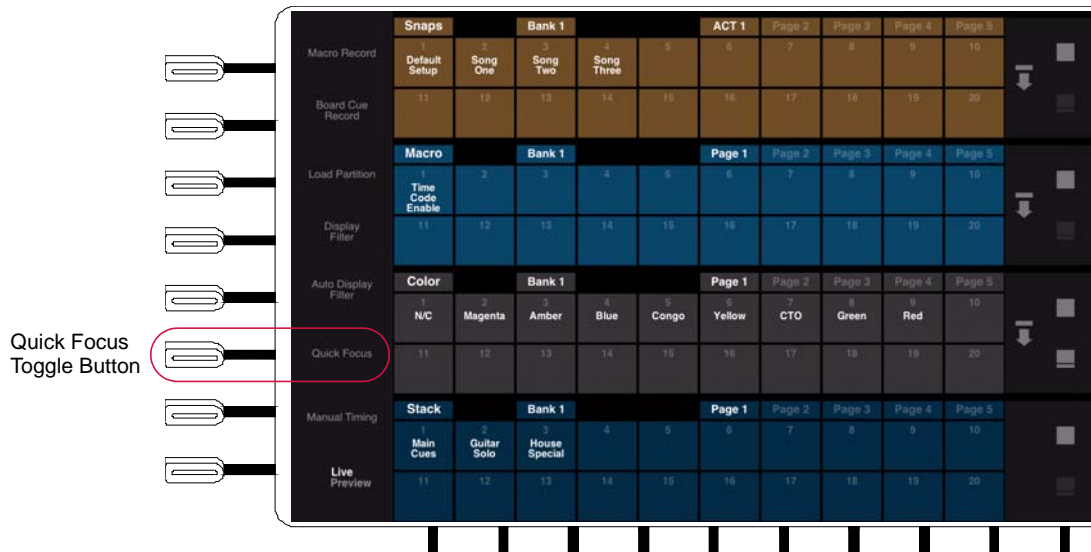



## Park

The Park feature allows you to place a luminaire into a state in which it will not respond to any manual or playback commands, nor will it store into any cues. This feature is useful for setting up work lights or other special lights that won't be part of the show.

### Park a luminaire using menu bar:

- Step 1. Select required channels.
- Step 2. At **Special** menu, select **Park**. Selected channels will now be parked.

### Release a parked luminaire using menu bar:

- Step 1. At **Special** menu, choose **Select Parked**. All Parked luminaires will be selected.
- Step 2. At **Special** menu, select **UnPark**. Luminaires will now respond to commands as usual.

Special	Patch	Window	Info
Task Progress			⌘%T
Clear Status Errors			
Enable Remote Focus Control			
Park			
UnPark			

Special	Patch	Window	Info
Task Progress			⌘%T
Clear Status Errors			
Enable Remote Focus Control			
Park			
UnPark			
Select Parked			

Special	Patch	Window	Info
Task Progress			⌘%T
Clear Status Errors			
Enable Remote Focus Control			
Park			
UnPark			
Select Parked			

## Highlight

Highlight provides a method for identifying a particular fixture or set of fixtures by putting them into a predefined state which distinguishes them from the rest of the system. When the [Highlight] button is pressed (or **Highlight** is selected from the **Special** menu), all selected channels will go into the defined highlight state. The [Highlight] button will flash to indicate that highlight is active. Pressing [Highlight] again will exit the highlight state.



Special	Patch	Window	Info
Task Progress			⌘ ⌘ T
Clear Status Errors			
Enable Remote Focus Control			
Park			
UnPark			
Select Parked			
Encoder Fan			▶
QuickFocus			⌘ F
<b>Highlight</b>			
Select			▶
Manual Timing			

If there are multiple channels selected and the [Next] or [Last] button is pressed, all highlighted channels but one will go to the defined "lowlight" state, and the single (selected) channel will be highlighted. As long as highlight is active, selected channels will go to the highlight state.

Pressing [Next] + [Last] will highlight all fixtures in the selection.

The highlight and lowlight states are defined in the new Highlight tab of the Settings window. The states can include an intensity level, a Color palette item, a Beam palette item, and/or a Preset.

### Guidelines:

- + The settings are applied in sequence and can overwrite each other.
- + Items that are not checked will be ignored.
- + The default states are full intensity for highlight and no action for lowlight.
- + The user-defined highlight and lowlight states are also used for QuickFocus.

Setup	Operation	Data
Settings		
Ethernet		
Pairing		
System Config		⌘ K
Calibrate Screen		
Legacy Media Setup		
Media Server Setup		
Log		⌘ L
Plan View		⌘ B
Patch		⌘ T
3D Location		
DMX Setup		

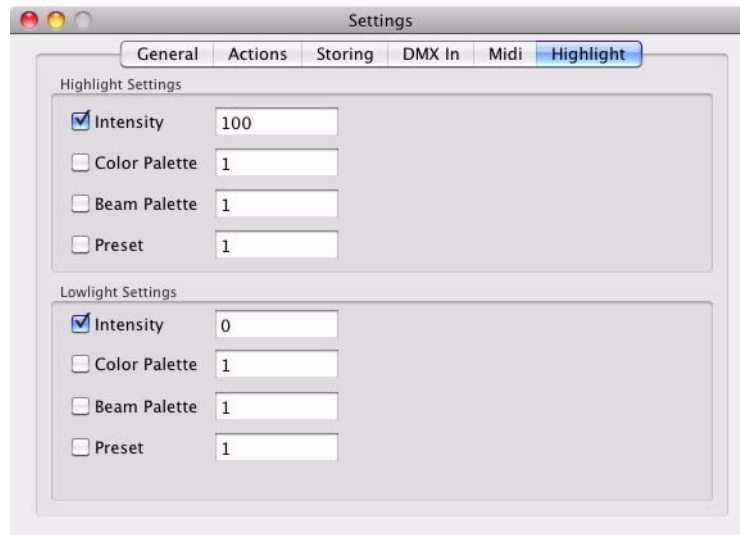

## DATA COPY AND MOVE

---

### Copy Channel

The Copy Channel feature is used to copy current parameter settings from one luminaire to another (or to a group of luminaires). All parameter settings, including any timing values, can be copied - as permitted by any filter settings at the touchscreen. Cue data, however, will not be copied.

The luminaire from which data is being copied is referred to as the "source" luminaire. The luminaires receiving the data are referred to as "target" luminaires. The target luminaires will immediately conform to the selected parameter data (including spin properties) of the source luminaire. If the source luminaire does not have data stored for a particular parameter or the parameter has been filtered from the operation, then the target luminaires will not change their current settings for those parameters. Once the target luminaires have conformed to the new parameter data, you may store a new cue or continue to manipulate the luminaires via manual control and then store a cue.

### How Data is Derived from Presets

If the source luminaire contains data provided by a Preset, then the system uses a hierarchy to determine how to translate this data to the target luminaire. The system will first look for a matching Preset number. For example, if the source contains data from Preset 2, then the new luminaire will look for Preset 2. If no matching Preset is found, then it will look for a matching palette. If no palette is found, then the new luminaire will conform to the parameter(s) by utilizing absolute data.

### Copy a single channel:

- Step 1. Select target channel(s).
- Step 2. At touchscreen, set filters. (Refer to "Function Filter" on page 93.)
- Step 3. At keypad, press [Recall] [Chan] [n] - where n is the number of the channel you wish to copy.

### Multi-Channel Copy Channel

It is also possible to copy parameters from multiple channels to multiple channels. This can be accomplished as follows:

- + The command [Recall] [Chan] <channel expression> will copy the filtered parameters of the specified channels to the selected channels (using selection order). For example, if channels 1-6 are selected, the command [Recall] [Chan] [11] [Thru] [12] will copy the parameters of channel 11 to channels 1, 3, 5 and the parameters of channel 12 to channels 2, 4, and 6.
- + Groups can also be used as a copy source. For example: [Recall] [Chan] [Group] [1].

### Copy/Move

The Copy/Move feature allows manipulation of Preset, Color, Beam, Group, Macro, Snapshot, Effect, Dynamic, Stack, Sequence, Set and Cue data. For example, the data content of Cue 1 could be copied to Cue 2 using this feature. In this case, Cue 1 and Cue 2 are now identical. When data is moved, for example from Cue 1 to Cue 2, the content of Cue 1 is moved to Cue 2 and there will no longer be a Cue 1 in the cue list.

---

**Note:** Moving channel data for a preset will now update any cues for that channel which reference that preset so they point to the new location.

---

Pressing the [Copy/Move] button once activates the *copy* feature, while double-clicking activates the *move* feature.

### Copy a cue to a new number:

- + At keypad, press [Copy/Move] [Cue] [1] [At] [201] [Enter] - copies Cue 1 data to Cue 201.

### Copy a range of cues to a new number range:

- + At keypad, press [Copy/Move] [Cue] [1] [Thru] [5] [At] [201] [Enter] - copies Cues 1-5 to Cues 201-205.

### Move a cue to a new number:

- + At keypad, press [Copy/Move] [Copy/Move] [Cue] [1] [At] [201] [Enter] - moves Cue 1 data to Cue 201 (Cue 1 is now blank).

### Move a range of cues to a new number range:

- + At keypad, press [Copy/Move] [Copy/Move] [Cue] [1] [Thru] [5] [At] [201] [Enter] - moves Cues 1-5 to Cues 201-205 (Cues 1-5 are now blank).

---

**Note:** Preset, Color, Beam, Group, Macro, Snapshot, Effect, Dynamic, Stack, Effect, Sequence, or Set can be substituted for Cue in the above examples.

---

---

**Note:** For a range of cues greater than 10, a confirmation dialog window will be displayed.

---

### Copy or Move a submaster:

- + [Copy]/[Move] [Sub] n [At] m, *or..*
- + Press and hold [Copy] or [Move] then, on the touchscreen, select the source and then the destination submaster.

## Copy Data

The Copy Data feature allows you to copy all the data from one channel to another, or to multiple channels. This is useful if additional luminaires are added to an existing lighting rig. When copying to multiple channels, the data will only be copied to luminaires of the same type as the source, leaving others unchanged.



---

**CAUTION:** There is no Undo for this action, so it is recommended that a backup of the show file is made for archive purposes.

---

### To copy data:

- Step 1. Select control channel(s) of luminaire(s) to receive data.
- Step 2. At **Data** menu, select **Copy Data**.

---

**Note:** Only one copy data action can be done at a time, from a single source.

---

- Step 3. A dialog window will open that allows selection of a source channel number. Click **OK**.

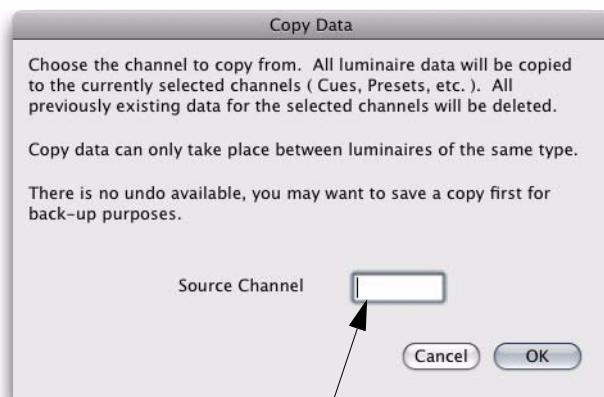
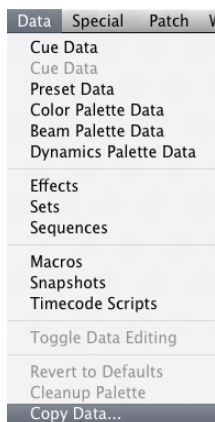

Enter source channel to copy data *from*.

Step 4. A warning dialog window will open, warning that previous existing data (if any) in the destination channels will be deleted. If this is the desired action, click **Copy**.

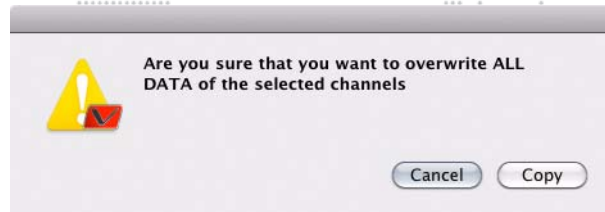

## Color/Beam Palette Copy

It is possible to copy data from luminaire-to-luminaire using the Color and Beam Palette Data windows. Copy and Paste of palette data allows either Paste Merge or Paste All actions. During the copy process, data will be appropriately mapped to the new luminaire.

- + **Merge** copies data only where existing data does not exist in the destination and will not over-write existing data.
- + **Replace All** clears out all of the existing destination data and replaces it with the source data.

### To copy/paste data:

- Step 1. At top of column, select name box of source luminaire.
- Step 2. At Mac keyboard, press WIN + C (to copy).
- Step 3. At top of column, selected name box of destination luminaire.
- Step 4. Press WIN + P (to paste).
- Step 5. At confirmation dialogue, press **Paste (Merge)** or **Paste (Replace All)**.

Select Luminaire Name Box

#	Label	VL6Cm6	VL5Am6	VL5m6	VL5Bm6	VL2000W	VL2000S	ASpot1...	iCove	MbE A...	MbE S
1	N/C	•		•	•						
2	Magenta	•		•	•						
3	Amber	•		•	•						
4	Blue										
5	Congo										
6	Yellow										
7	CTO										
8	Green										

▼ Data

Device	VL6Cm6	VL5m6	VL5Bm6
YL6Cm6			
YL5m6	0	0	0
YL5Bm6	0	0	0

## FUNCTION KEYS

---

### Setting Function Key Option

Selected keys from the command-line keypad are mapped to the computer keyboard's function keys F1-F12. Pressing these will open a window which takes the place of command-line functions such as Store, Selective Store, Delete, At, etc.

**Note:** Computer keyboard "quick keys" are available for use in these windows. Refer to "Quick Keys" on page 209 for instructions.

---

### Using Function Keys

#### Store - F1

- Step 1. Using windows, set parameters for cue, preset, beam, color, group, snapshot, macro, or board cue.
- Step 2. Press F1. (Store window will open.)
- Step 3. Select item to store.
- Step 4. Enter number for future recall.
- Step 5. Click OK.



**Note:** Plus is used with cue store operations. Selecting Plus and clicking OK will store cue to next cue number according to increment shown in Encoder window. Refer to "Encoders HUD Window" on page 70.

---

#### Selective Store - F2

- Step 1. Using windows, set parameters you wish to modify or add in a cue or preset.
- Step 2. Press F2. (Selective Store window will open.)
- Step 3. Select Cue or Preset.
- Step 4. Enter range of cues or presets.
- Step 5. Click OK.



#### Update - F3

- Step 1. Using windows, modify required channels.
- Step 2. Press F3. (Update window will open.)
- Step 3. Select item for update.
- Step 4. Enter item number where you wish to store modified channels.



### Track/Fill- F4

- Step 1. Press F4. (Track/Fill window will open.)
- Step 2. Enter a starting cue.
- Step 3. Click "OK" - tracks (or fills) from cue as specified.

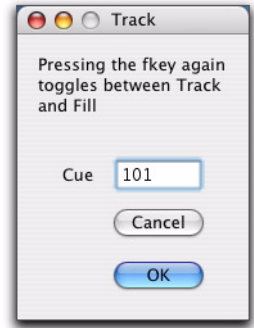

### Selective Recall - F5

- Step 1. At **Panels** menu, select **Timing Display**. (Timing window will open.)
- Step 2. Select **Filter** tab.
- Step 3. Select parameters to be recalled.
- Step 4. Press F4. (Selective Recall window will open.)
- Step 5. Select item from which data will be recalled.
- Step 6. Enter number of cue, preset, or channel.
- Step 7. Click **OK**.



### Delete - F6

- Step 1. Press F5.
- Step 2. Select item to delete.
- Step 3. Enter number of item.
- Step 4. Click **OK**.

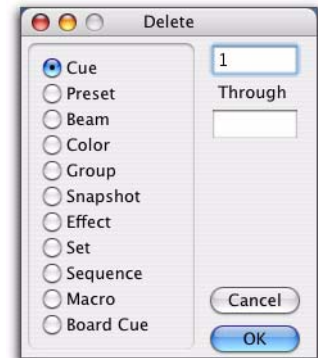

### At - F7

- Step 1. Select desired channel(s).
- Step 2. Press F7.
- Step 3. Select Full or Value. Enter value (1-100%).
- Step 4. Click **OK**.



### Copy/Move - F8

- Step 1. Press F8.
- Step 2. Press F8 again to toggle between Copy and Move windows.
- Step 3. At desired window, enter cue numbers for copy/move operation.
- Step 4. Click **OK**.

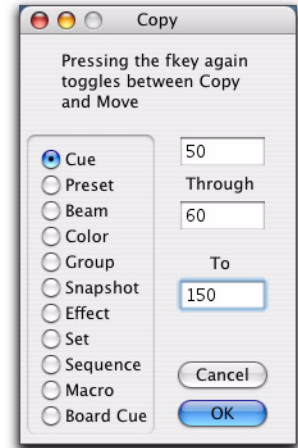

### Sneak - F9

- Step 1. Press and hold ALT while pressing F9.
- Step 2. Select parameter for sneak operation.
- Step 3. Enter parameter value.
- Step 4. Click **OK**.



### Select - F10

- Step 1. Press and hold ALT while pressing F10.
- Step 2. Select item.
- Step 3. Enter item number.
- Step 4. Click **OK**.

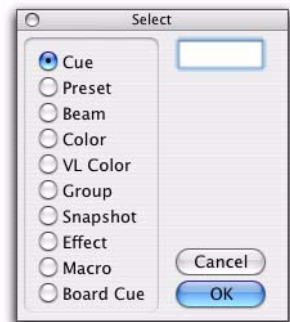

### Time - F11

- Step 1. Select a parameter(s).
- Step 2. Press and hold ALT while pressing F11.
- Step 3. Select Time, Speed, or Delay.
- Step 4. Enter value.
- Step 5. Click **OK**.





## Quick Keys

The following computer keyboard "quick keys" can be used as shortcuts to select options in the function windows (F1-F12). For example, while in the Time window, pressing the T key would select Time, S would select Speed, and D would select Delay.



B = Beam	M = Macro
C = Cue	O = Board Cue
D = Delay	P = Preset
E = Effect	Q = Sequence
F = Full	S = Snapshot or Speed
G = Group	T = Time or Set
H = Channel	U = Cue with Preset
K = Color	V = Value or PRG Color
+ = Plus	

The following "quick keys" can be used with the 3D Graphic window to adjust the camera angle:

- 4, 6 = left, right direction (also ARROW keys)
- 8, 2 = up, down (also ARROW keys)
- 7, 9 = zoom in, zoom out (also +, -)

The following "quick keys" can be used with the palettes:

ALT enables the Store function.  
(Hold ALT and click in cell to store a palette.)

WIN enables the Label function.  
(Hold WIN and click in cell to label a palette.)

## CONTROLLING MEDIA SERVERS

### Overview

Digital lighting media servers can be operated from the console using DMX512 protocol. When patched, the media server parameters can be controlled using the console encoders, windows and command-line keypad just as you would control automated luminaires.

Media servers are automatically created when an available media server is quick-patched from the patch dialog.

**Note:** For additional instructions specific to controlling a particular media server, refer to the documentation included with your media server.

### Media Server Setup

Once a media server is patched, it can be edited using the Media Server Setup window available from the **Setup** menu. All servers are listed along the left side of the screen, while settings for the selected sever are shown on the right. At the top of the window is a list of channels that are assigned to the selected media server.

*Guidelines:*

- + Server settings may only be changed while in Patch Edit mode.
- + Settings may be changed for multiple servers at once by using [Shift] or [Command] while selecting multiple servers in the left column.

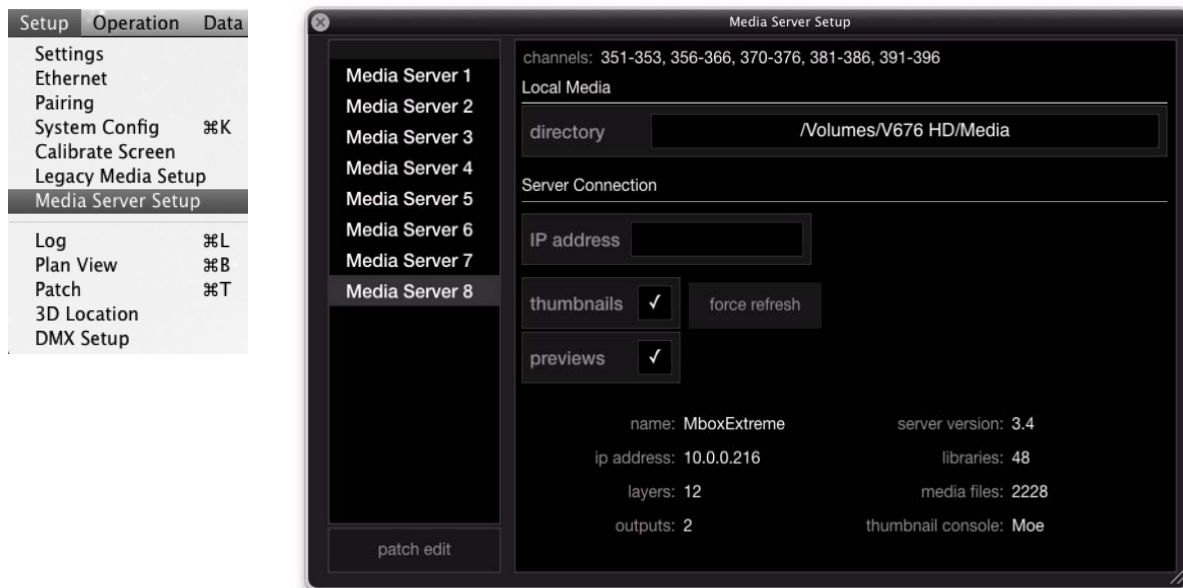

**Note:** This new Media Setup window was introduced with Vx76 software version 3.0. However, to accommodate older show files, the previous version of the Media Setup window is still available by selecting **Legacy Media Setup** from the **Setup** menu. Refer to "[Legacy Media Setup Windows](#)" on page 219.

## Editing Media Server Settings

To edit the settings for a media server, first select the server in the left column and then press the <patch edit> button. When patch editing is enabled, the button text will be yellow.

Select multiple servers at once by using [Shift] or [Command]. When multiple servers are selected, their settings can be changed universally.

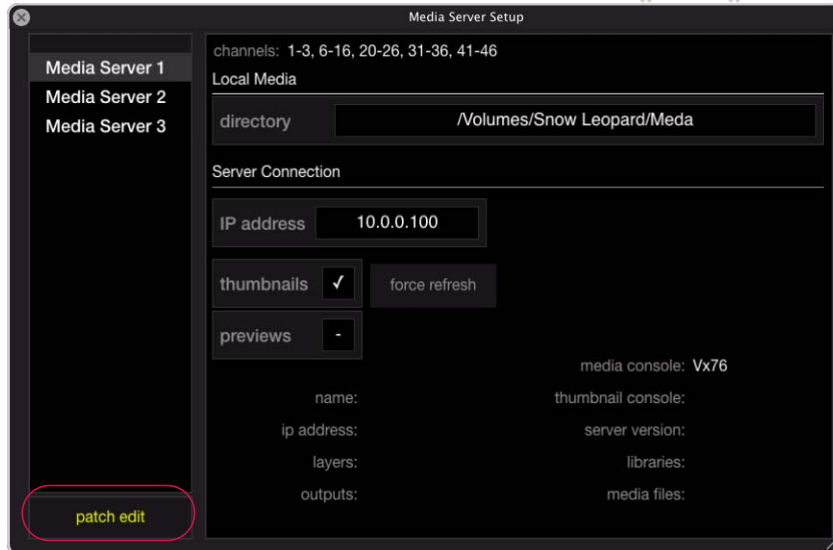

- + **Channels** - displays a list of channels that are assigned to the selected media server. This cannot be edited.
- + **Directory** - assigns a local directory which will be used to generate the media thumbnails. (For instructions about organizing media files, refer to "[Local Media Folder and File Numbering](#)" on page 213.) To choose a directory, click in the Directory field and select a location from the finder.

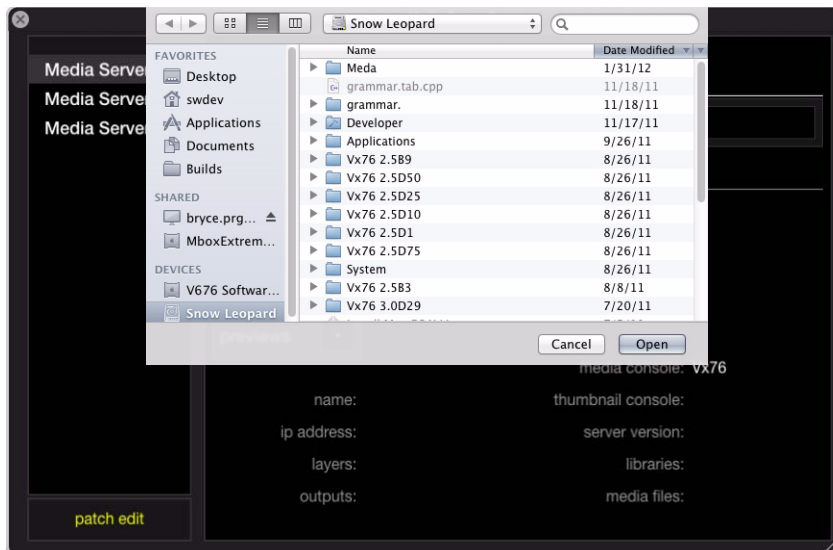

- + **IP Address** - displays the current IP address which corresponds to the CITP connection. To enter an IP address, touch inside the field to activate the numeric keypad.

---

**Note:** The CITP IP address used here may not be the same as the one used for DMX control.

---

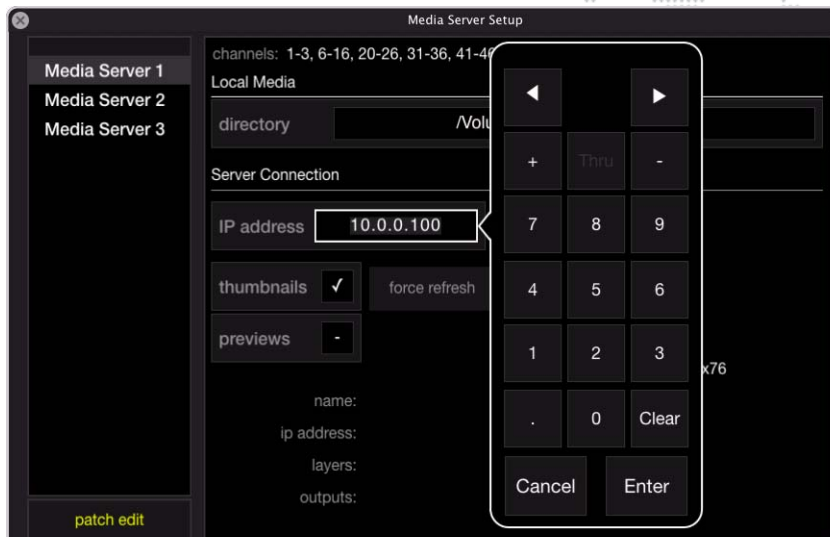

- + **Thumbnails** - tells the console to use the CITP-provided thumbnails when this box is checked.
- + **Previews** - enables/disables CITP previews for server and layer outputs.
- + **Force Refresh** - forces a refresh of the media thumbnails.

**Tip** ⇨ To refresh multiple servers at once, select multiple servers in the left column by using [Shift] or [Command] and then press the force refresh button.

- + **Info** - information as reported back to the console from the CITP server. This information consists of the media server's name, version, IP address, number of media libraries, layers and files, and outputs. The "thumbnail console" indicates which Vx76 console is generating the thumbnails. The screen image below shows example information from a connected Mbox Extreme Media Server with the thumbnails being generated from a console named "Moe."



## Local Media Folder and File Numbering

When creating a media library on the console, certain guidelines for naming the folders and files must be followed in order to view the thumbnails.

Each folder name must begin with a 3-digit index value. In turn, each file within the Library folder must be named using a 3-digit index value between 000 to 255 as a prefix.

Two control channels on the console will be used to select a Library folder and the numbered file within that folder.

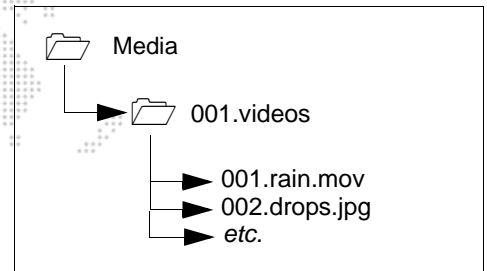

Library folders within the *Media* folder must have a number prefix and can have a descriptive name separated from the number by a period, dash, underscore, or a space. For example:

**025.Central Park or 025 Central Park**

Files within each library folder must have a numerical prefix, can have a descriptive name if desired, and must have a three-letter file extension. Each of these parts should be separated by a period:

**001.Great Lawn.jpg or 001.jpg**

Movie and still image files may be numbered between 000 and 255 and placed in folders numbered 000 - 254.

When adding content files, DO NOT duplicate existing folder and file number combinations. It is best to make new folders for custom content.

Leading zeros are not required when numbering folders or files, but they can help by making the file listing easier to read.

## Media Palette

Patched media servers can be accessed in the Media palette as shown below:

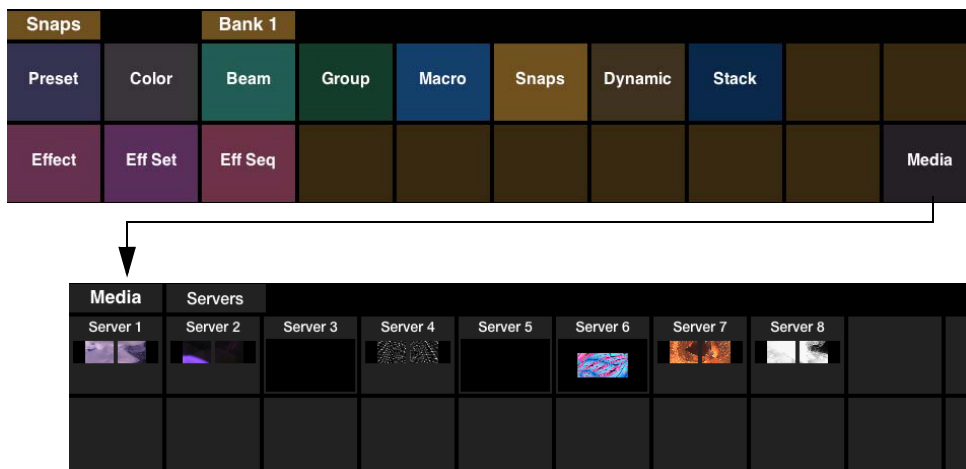

**Note:** The new Media palette was introduced with Vx76 software version 3.0. However, to accommodate older show files, the old Media control window is still available by selecting **Media** from the **Operation** menu. Refer to "[Legacy Media Setup Windows](#)" on page 219.

The Media palette retrieves data from the connected server(s) via CITP and displays a small content thumbnail (if available) in the palette. It also provides live streaming status for the server and layers via CITP.

To view and/or edit server properties, touch the server's palette button. Navigation tabs will appear at the top of the palette as the server properties are navigated.

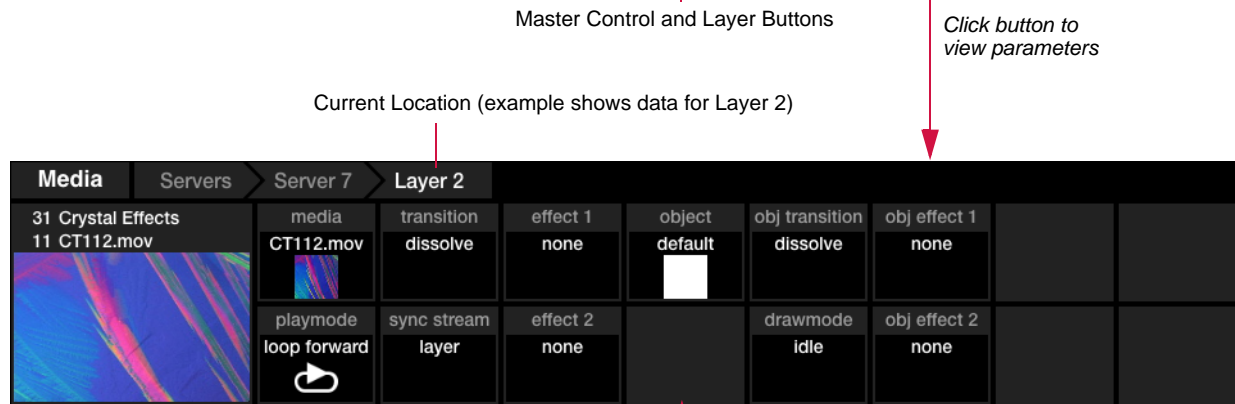
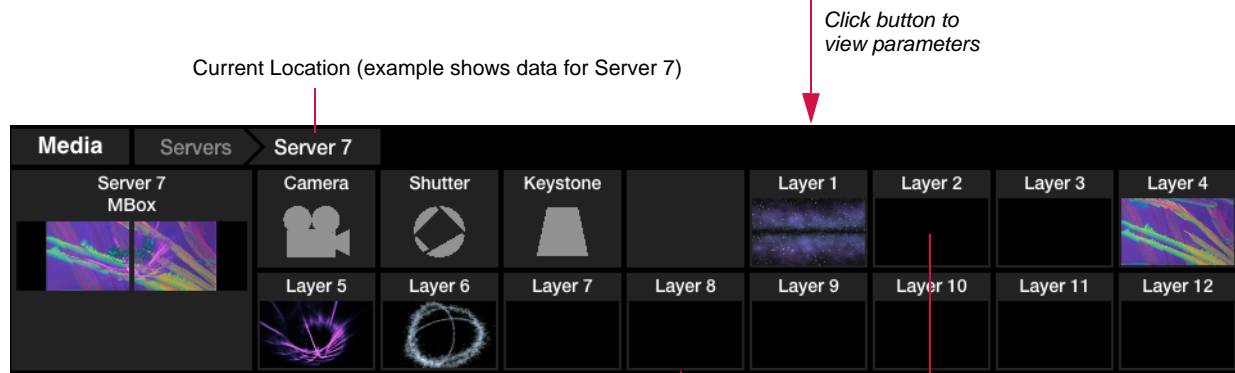
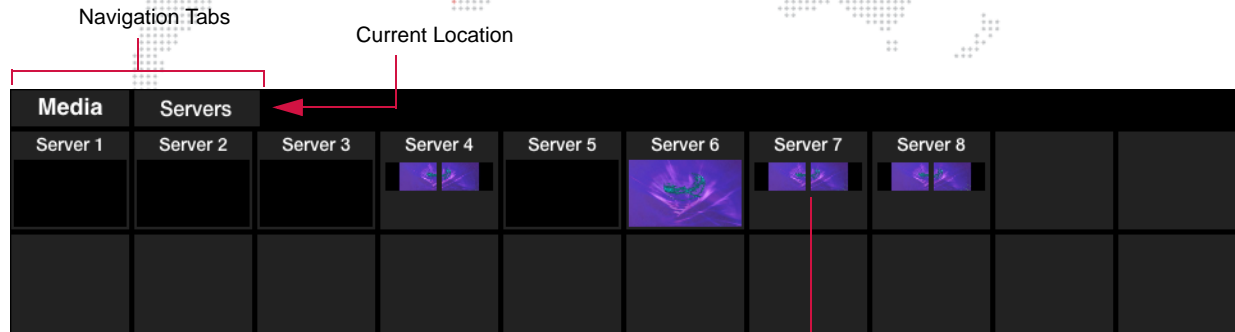

Layer Parameters

## Media Super Palette

A Media super palette can be accessed by pressing the super palette icon at the right of any visible Media palette:

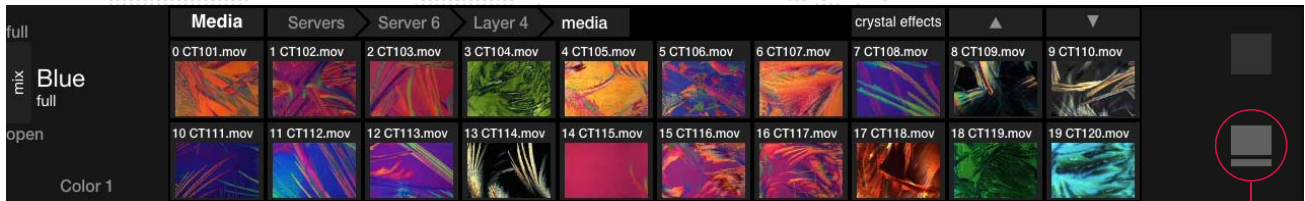

The Media super palette displays the contents of all 12 layers:

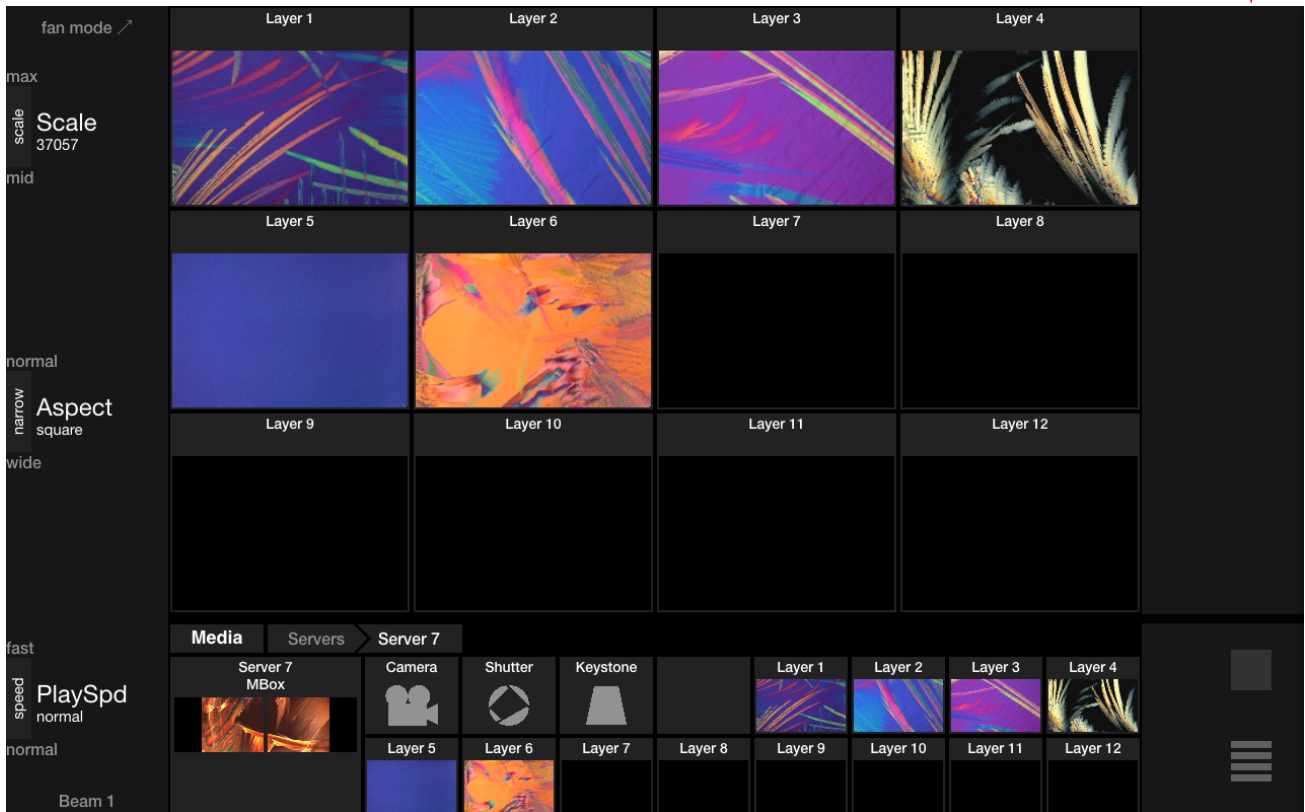

The Media super palette will also display media clip options when a layer parameter is touched. The library can be navigated using the list on the left side of the screen. The currently selected media clip will be displayed in the layer's thumbnail and the library/media file number will be displayed at the right side of the screen as shown below:

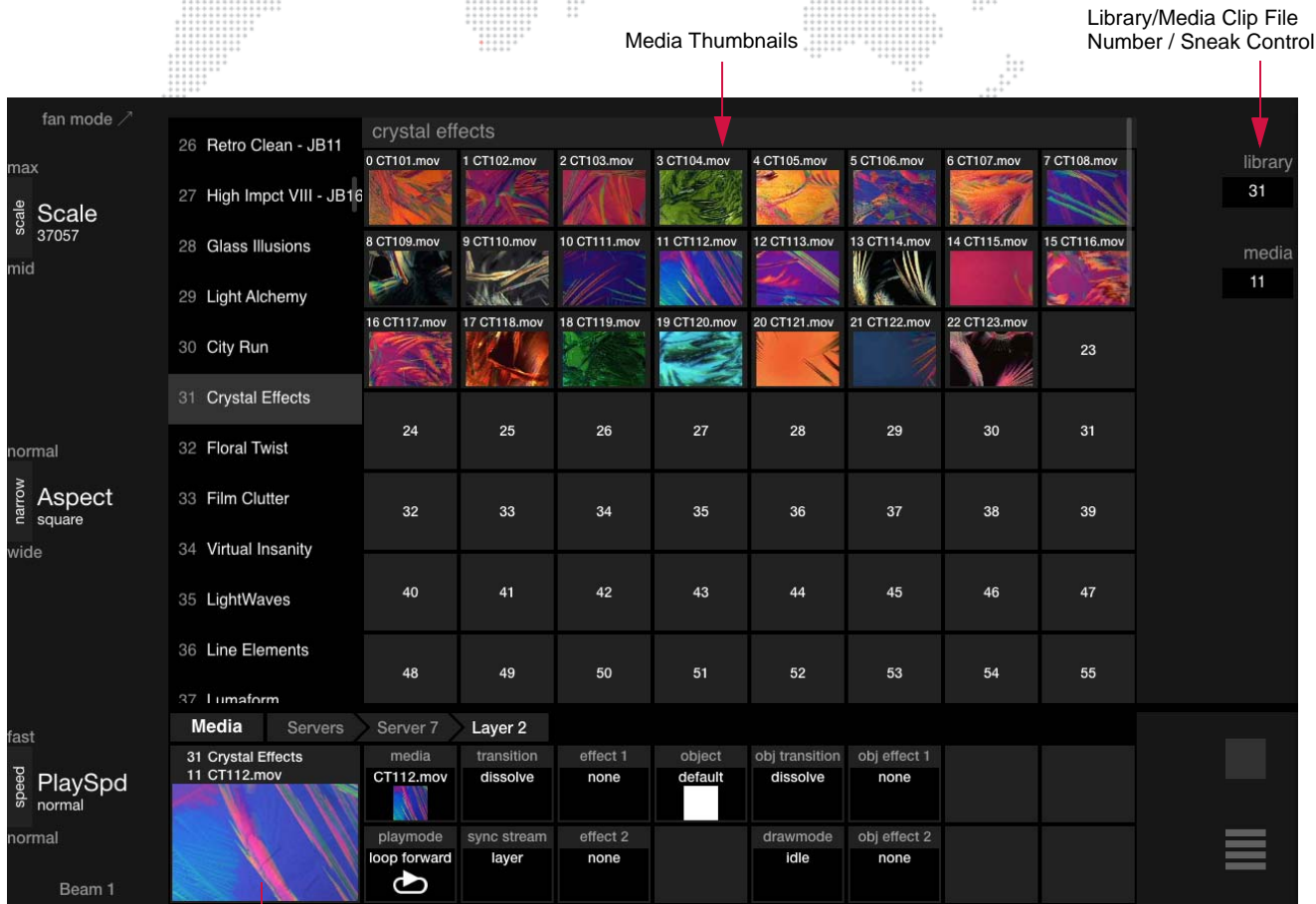

Currently Selected Media Clip

**Note:** For more detailed information regarding media server operation, refer to the user manual included with your particular type of media server.



## Media Library / File Sneak

Both the Library and File values can be "sneaked" at the same time by entering one value in the sneak keypad and tapping the other value without pressing enter on the first keypad. Only when the virtual keypad's (Enter) button is pressed will the values be sent out.

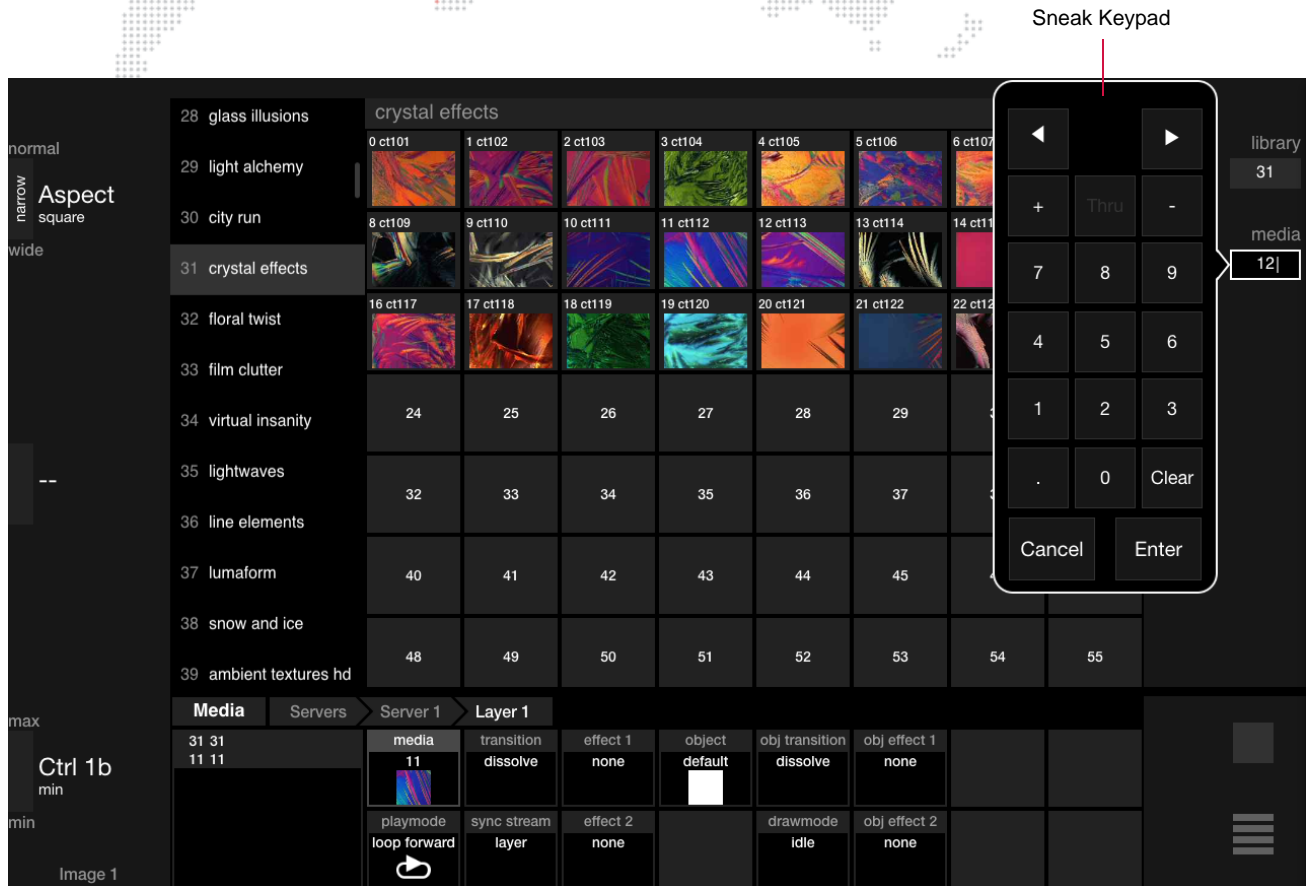

## Server View Lock

When viewing a media server at the Server level, the view can be locked so that the palette can be used as a visual channel select. When locked, a small lock icon will appear and button presses will make channel selections, but not burrow to the fixture level.

### To lock view:

- + Hold down front panel [Option] key and tap server's label. This will lock the view to that server.

### To unlock view:

- + Hold front panel [Option] key and press server's label again.

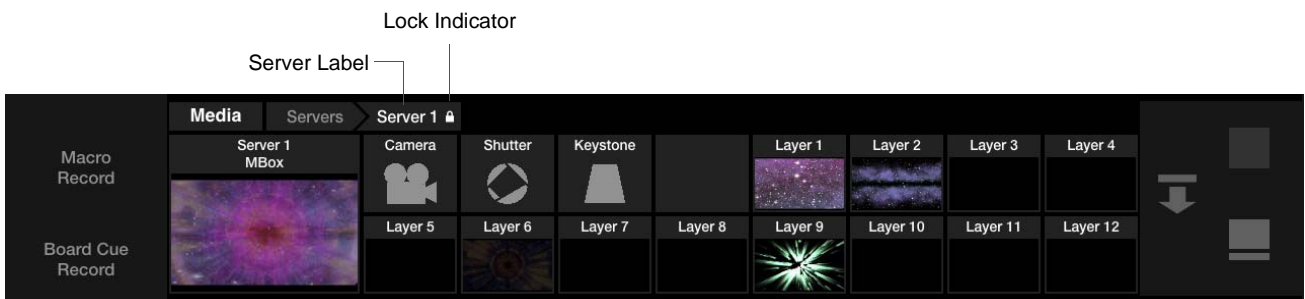

## Server Control

The Media palette provides control options as applicable to the particular type of media server that is selected. For example, press the playmode button from Layer 1 as shown below. The play mode options will be displayed in the super palette. Select a play mode as required. The play mode's number will be displayed at the right side of the palette.

play mode									
0 loop forward	14 loop reverse	24 once forwrd	34 once revrse	44 bounce fwrc	54 bounce rvrse	64 random	74 once forwrd	84 scrb in frme	94 scrb out frme
104 loop forward XFde at loop	114 loop reverse XFde at loop	124 loop forward on in-frme chi	132 timecde sync strict lock	135 timecde sync sync thn freev	136 timecde sync jam sync	144 layer slave	154 layer master loop forward	164 layer master once forward	180 kiosk mode once through
181 kiosk mode once through loop last	182 kiosk mode once through fade out	187 kiosk mode loop through	194 kiosk mode timecode	240 play out mde last 5 scnds	241 play out mde last 10 scnds	242 play out mde last 15 scnds	243 play out mde last 20 scnds	244 play out mde last 30 scnds	252 restart frm crnt in-fr

  

Media	Servers	Server 1	Layer 1
0 none	media	transition	effect 1
0 none	none	dissolve	none
	playmode	sync stream	effect 2
	loop reverse	layer	none

## Legacy Media Setup Windows

A new Media Setup window was introduced with Vx76 software version 3.0 (refer to "Media Server Setup" on page 210). The new window should be used on all new show configurations, however, the previous version of the Media Setup window is still available for shows that are already programmed using this older interface.

The legacy Media Setup window can be accessed by selecting **Legacy Media Setup** from the **Setup** menu.

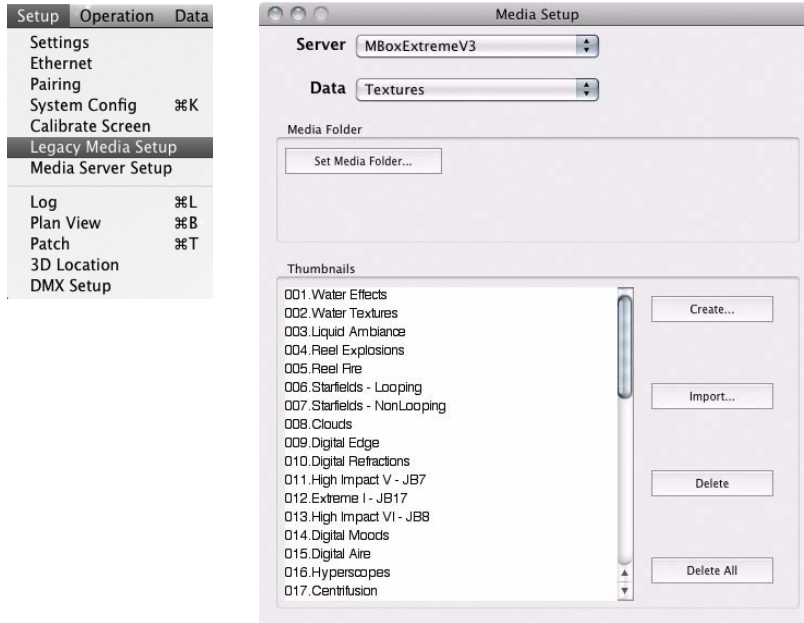

## CITP: Controller, Interface, Transport, Protocol

Use the following procedure to connect a Vx76 console to an Mbox Extreme Media Server.

### Important Notes:

- + Before starting, make sure you have the latest version of the Mbox Daemon, as well as the Mbox Extreme version that matches the Daemon.
- + When the Mbox Extreme application is launched, it will atomically launch the Mbox Daemon application. You can confirm that Mbox Daemon is running by pressing [⌘ D] (while Mbox Extreme server is in Window mode).

### To connect a Vx76 console to an Mbox Extreme server:

- Step 1. At Mbox Extreme server, verify Mbox Daemon version and make sure **Ethernet 2** is enabled at **Network Interface** pull-down bar.
- Step 2. At **MSEX** pull-down bar, select version **1.0**. (The Commands pull-down bar is not needed for this procedure.)

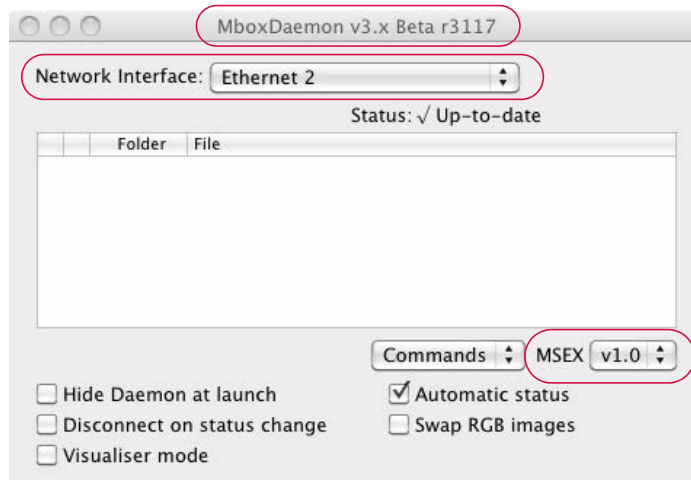

Step 3. Verify Mbox Extreme version and launch application.

Step 4. At Mbox Extreme main window, click on **Setup** tab.

Step 5. At Network section, select **Ethernet 2** from CITP pull-down bar.

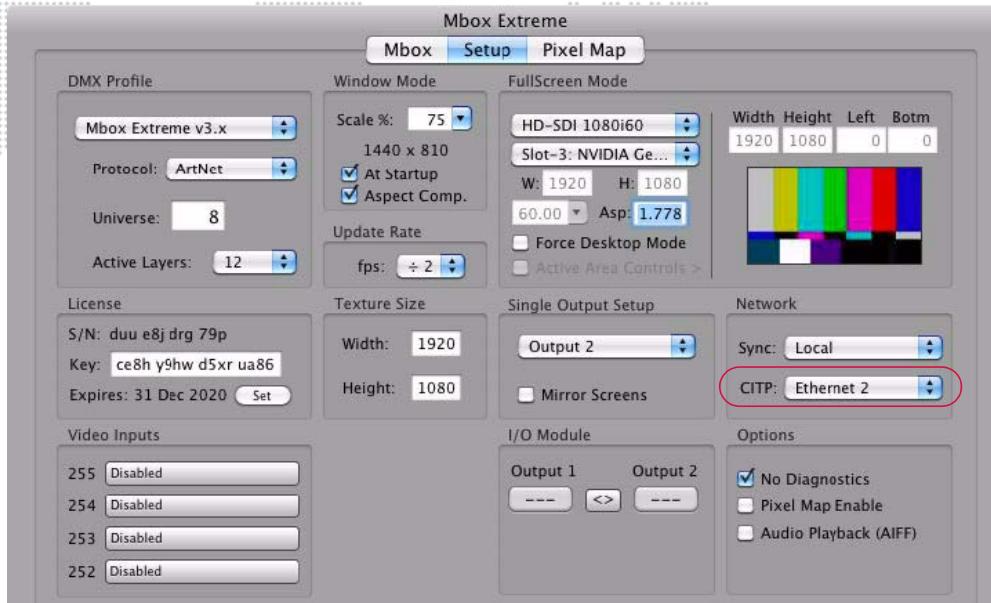

Step 6. At Mbox Extreme desktop, select **System Preferences** from Apple menu.

Step 7. At System Preferences window, click on **Network**.



Step 8. At Network window, be sure Ethernet 2 is green and IP Address and Subnet Mask match the numbers shown below:

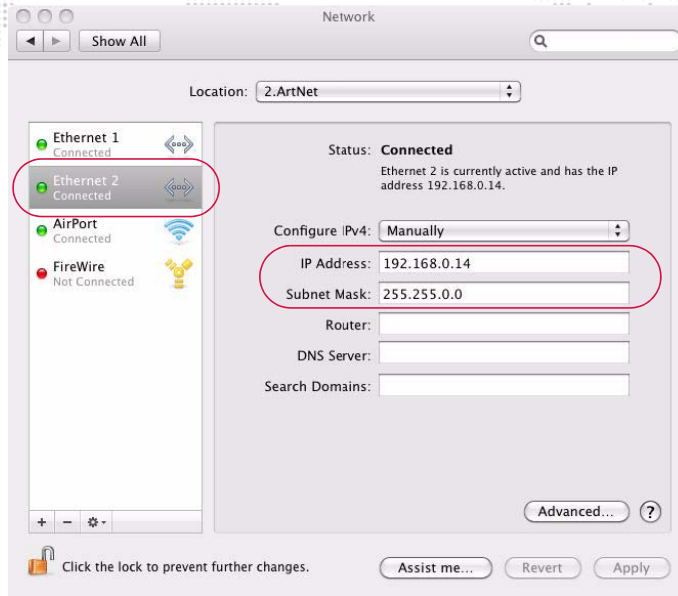

Step 9. At Vx76 console desktop, select **System Preferences** from Apple menu.

Step 10. At System Preferences window, click on **Network**.



Step 11. At Network window, be sure Ethernet 2 is green and IP Address and Subnet Mask match the numbers shown below:

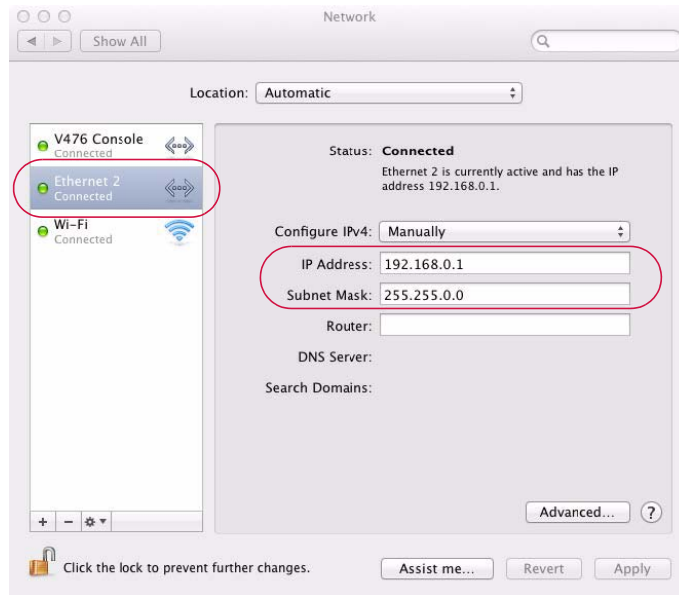

Step 12. Be sure Vx76 console profiles are up to date. (Refer to "Updating Profiles" on page 346 for more information.)

Step 13. Patch an Mbox Extreme Media Server. (Refer to "Patch Procedures" on page 28 for more information.)

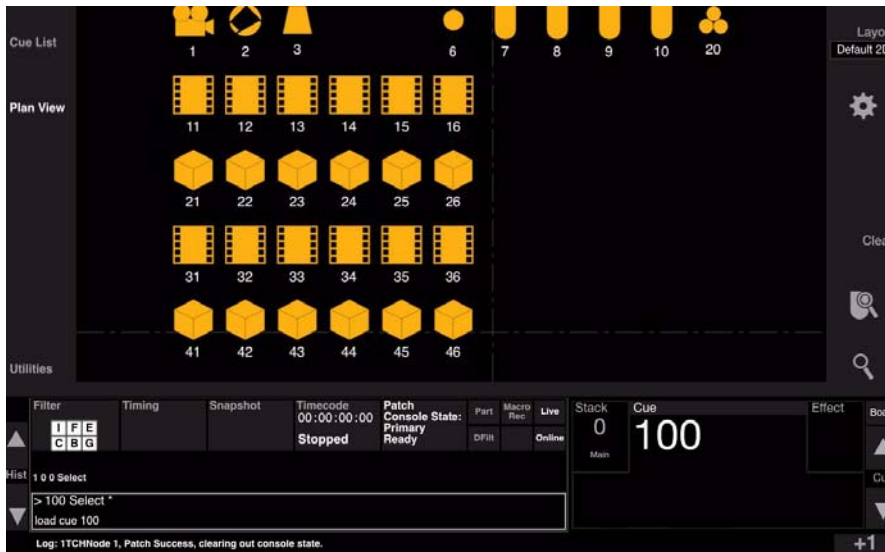
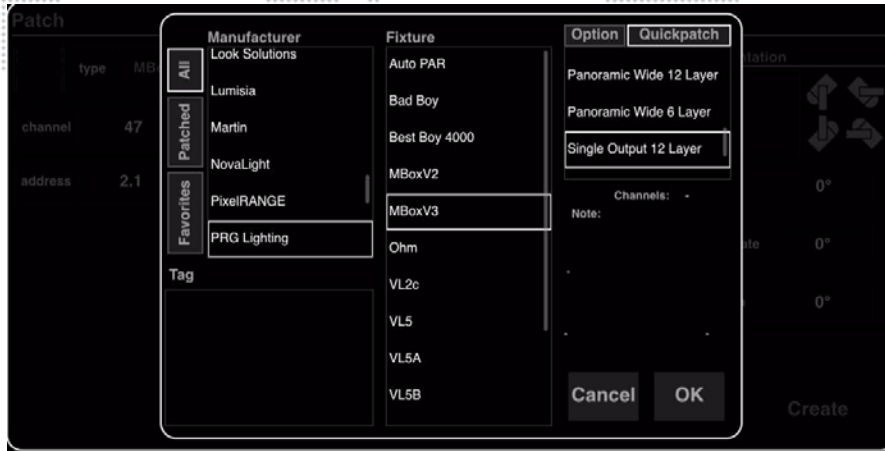



Step 14. At **Setup** menu, select **Media Server Setup**.

Step 15. At Media Server Setup window, be sure **Show Server Previews** is checked.

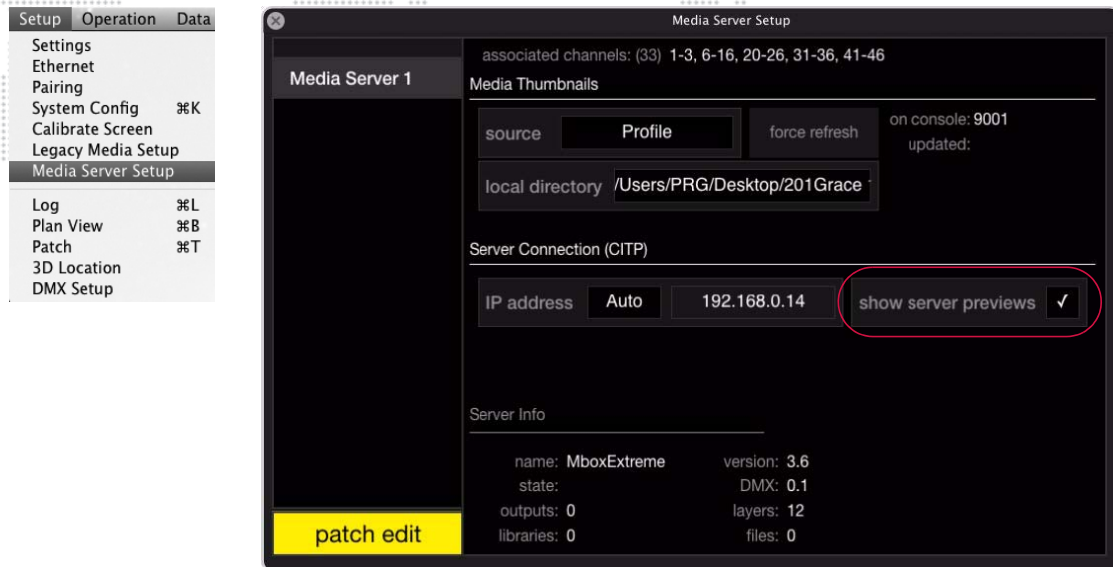

Step 16. At **Setup** menu, select **Ethernet**.

Step 17. At Ethernet window, be sure **CITP Interface** pull-down menu is set to **Ethernet 2** and that the server link is active and that server traffic is detected.

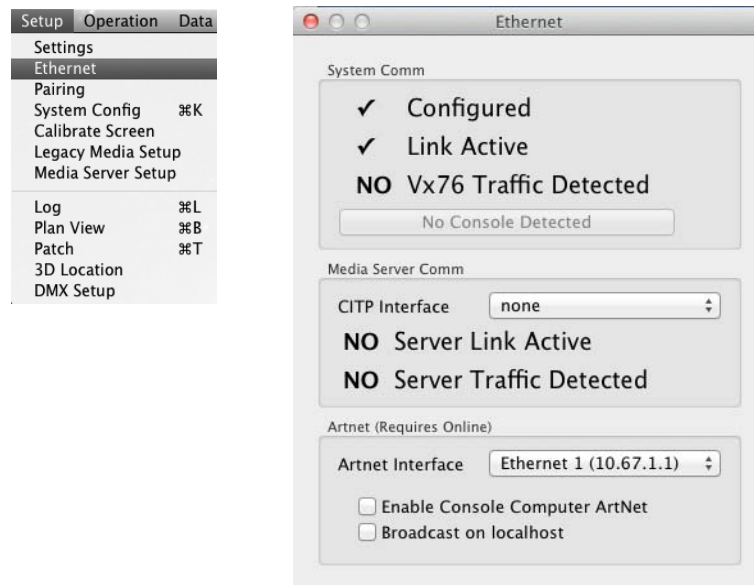

Step 18. Open Media palette, choose a server and verify that C1TP is sending frames back to the console.

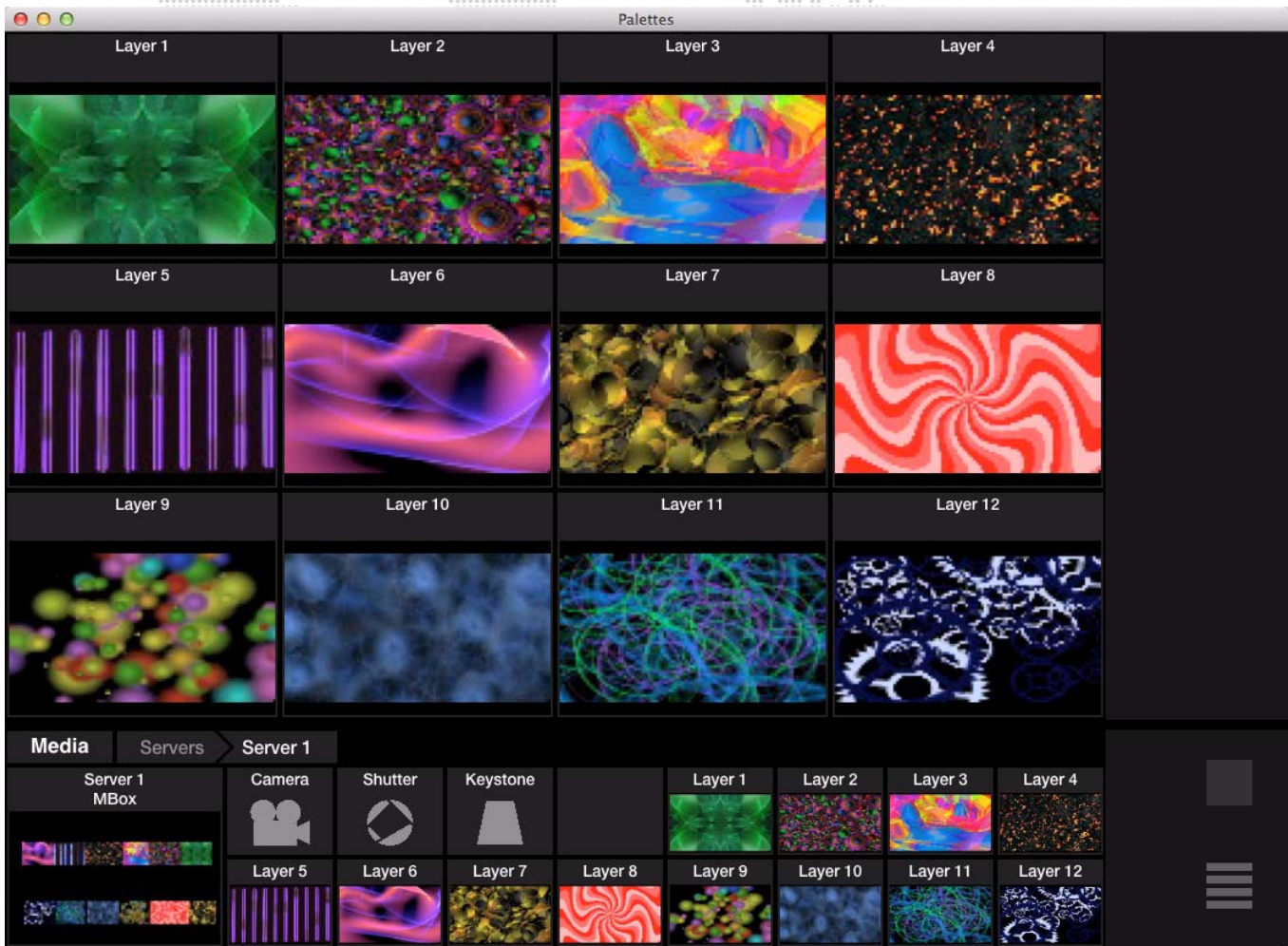



## 10.

# SNAPSHOTS, MACROS, & BOARD CUES

This chapter provides instructions for storing custom console setups and frequently used programming actions, and for configuring submaster playback with board cues.

- + **SNAPSHOTS**
- + **MACROS**
- + **BOARD CUES**

# SNAPSHOTS

## Overview

A snapshot is a captured state on the console which can be recalled at any time in the future. States such as Channel Select panel selections, touchscreen status, submaster setups, and windows layouts can be captured as a snapshot. Snapshots can be recalled via manual selection of the associated snapshot number or by automated activation through the cue sheet via link instructions. Snapshots may also be included in macros.

Snapshots can be stored using the Snapshot Filter window or front panel touchscreen. The graphic interface allows you to select those areas of the console you wish to include in a snapshot store operation.

Control areas that may be included in a snapshot are:

- + Channel Select Panel - stores the page and current selected channels. When the snapshot is recalled, it is displayed at the Channel Select window and Channel Select panel if applicable.
- + Monitor 1 - stores the windows layout on monitor 1.
- + Monitor 2 - stores the windows layout on monitor 2.
- + Monitor 3 - stores the windows layout on monitor 3.
- + Encoders - stores the current encoder status.
- + Palettes - stores configuration including bank and page selection, as well as, active states such as QuickFocus and Manual Timing.
- + Center Display - stores configuration for the central command-line touchscreen.
- + System Configuration - stores system configuration settings.
- + Submaster Display and/or faders - stores the current state of any or all submasters. This includes active submaster banks (1-10, 11-20, 21-30). The submaster control, settings, function filters, rates, operating modes, the active and pending cues, etc. are all saved as part of the snapshot.

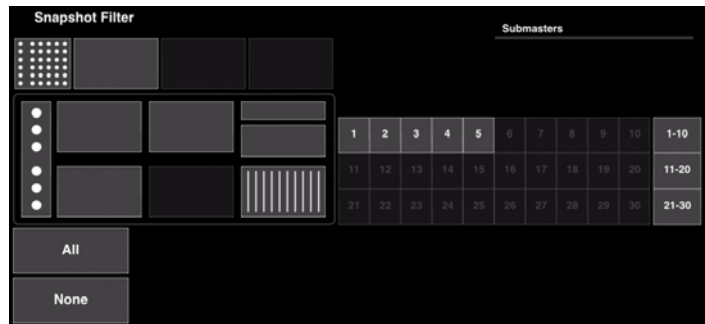

Snapshot Filter

**Tip** ⇨ Pressing the [Snap Shot] button in the command line will bring up the Snapshot Filter window.

## Storing Snapshots

Snapshots are stored in the Snapshots palette banks and can be accessed on any of the palettes just as Presets, Colors, Beams, Groups, Macros, and Effects or from the keypad. For instructions on using the palettes, refer to the "Palettes" chapter on page 103.

### Store a snapshot using the palette:

- Step 1. Configure console as required.
- Step 2. At central touchscreen, press (Snapshot) button. Snapshot Filter will open.

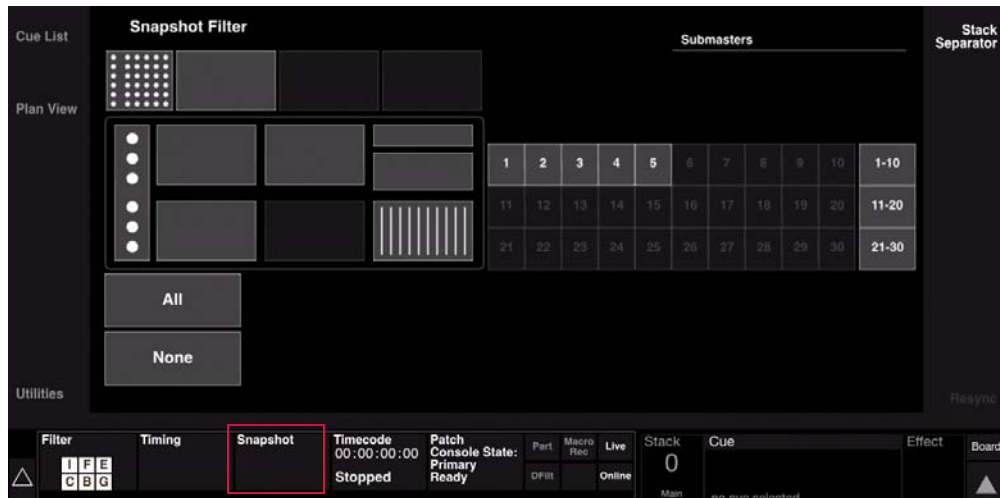

- Step 3. At Snapshot Filter, select console areas to be snapshot. (They will be highlighted in gray.)
- Step 4. At palettes, select (Snaps).
- Step 5. Press and hold [Store] while pressing (Snapshot Palette Button). Snap shot will be stored in the palette.

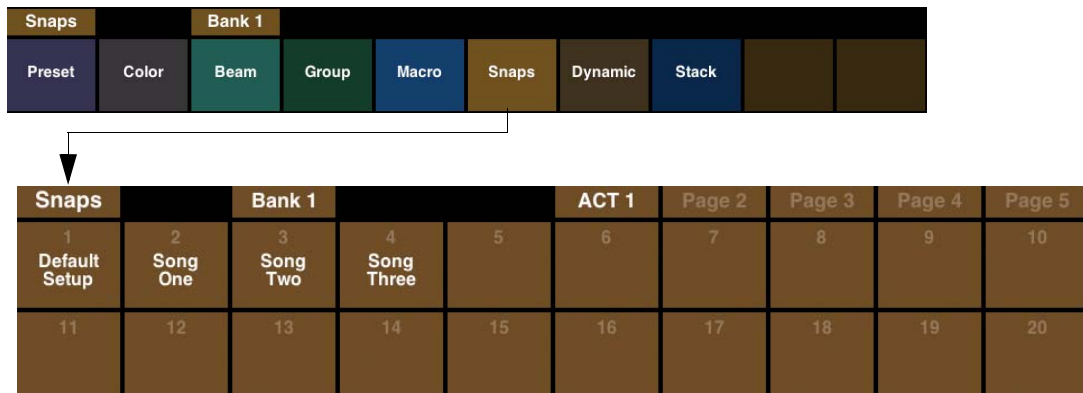

Snapshot Palette Buttons

### Store a snapshot using keypad:

- Step 1. Configure console as required.
- Step 2. At central touchscreen, press <Snapshot> button. Snapshot Filter will open.

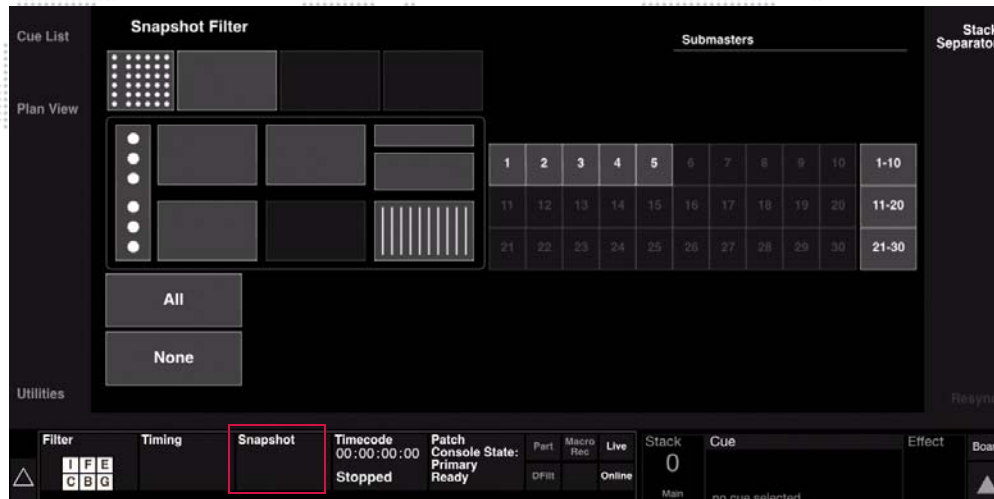

- Step 3. At Snapshot Filter, select console areas to be snapshot. (They will be highlighted in gray.)
- Step 4. Press [Store] [Snap Shot] [n] [Enter].

### Label a snapshot:

When labeling, the name can be entered on the console touchscreen keyboard *or* computer keyboard.

- + [Label] [Snap Shot] [n] [xxxxxx] [Enter/Accept], *or*
- + Press and hold [Label] while pressing <Snapshot Palette Button> [xxxxxx] [Enter/Accept].

Snaps		Bank 1			ACT 1	Page 2	Page 3	Page 4	Page 5
1 Default Setup	2 Song One	3 Song Two	4 Song Three	5	6	7	8	9	10
11	12	13	14	15	16	17	18	19	20

↑  
Snapshot Palette Button

### Create a snapshot and associate it with a cue using shortcut method:

In this case, the current front panel settings are stored into the snapshot according to the filters currently enabled in the Snapshot Filter and automatically associated with the cue. The snapshot stored using this method is given an invisible snapshot number of 1000 or above. The number is chosen by the console and cannot be accessed in the Snapshot Data window.

- Step 1. Configure console as required.
- Step 2. At central touchscreen, press <Snapshot> button. Snapshot Filter will open.
- Step 3. At Snapshot Filter, select console areas to be snapshot. (They will be highlighted in gray.)
- Step 4. Press [Store] [Cue] [n] [Link] [Snap Shot] [Snap Shot] [Enter]. Snapshot will be created and associated with Cue n.

---

**Note:** Each snapshot created this way will be unique to that cue. Commonly used snapshots should first be created and then linked to a cue using the Link command. Refer to "Link" on page 250.

---

### Create a snapshot cue using a submaster:

- + Press and hold [Snap Shot] while touching a specific submaster on the touchscreen. This will create a snapshot for the cue in that particular submaster.

### Deleting Snapshots

A snapshot can be deleted using the keypad Delete function.

#### Delete snapshot(s):

- + [Delete] [Snap Shot] [n] [Enter], *or*
- + Press and hold [Delete] while pressing <Snapshot Palette Button>.

### Recalling Snapshots

When a snapshot is recalled, any cues that were in active playback will be recalled in their stored times. Any cues that were in pending will be placed in the appropriate pending files.

#### Recall snapshot using the palette:

- Step 1. At palette, select <Snaps>.
- Step 2. Press desired <Snapshot Palette Button>.

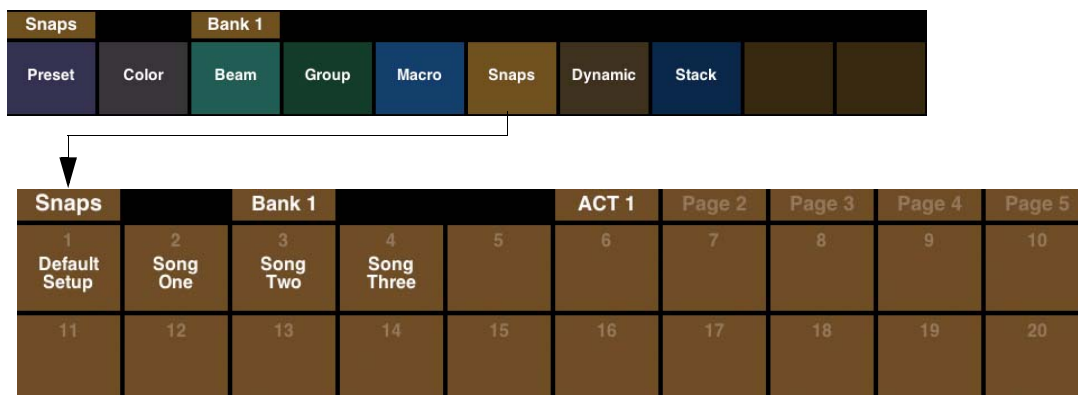

Snapshot Palette Buttons

#### Recall snapshot using command-line keypad:

- + Press [Snapshot] [n] [Enter] (where n is the discrete snapshot number).

### Recall snapshot via link:

- + <Cue> [n] [Link] [Snap Shot] [x] [Enter] - links Snapshot x to Cue n.
- + [Board Cue] [n] [Link] [Snap Shot] [x] [Enter] - links Snapshot x to Board Cue n.

### Recall a snapshot via a macro:

- + While recording a macro, recall a snapshot. When the macro is played back, the snapshot will be recalled. (Refer to "Macros" on page 233.)

### Copy a range of snapshots:

- + [Copy/Move] [Snap Shot] [n] [Thru] [m] [At] [y] [Enter] - where n is the first snapshot in the range, m is the last snapshot in the range, and y is the new location for the range.

### Move a range of snapshots:

- + [Copy/Move] [Copy/Move] [Snap Shot] [n] [Thru] [m] [At] [y] [Enter] - where n is the first snapshot in the range, m is the last snapshot in the range, and y is the new location for the range.

## Cue Snapshot Effect Loading

When a cue or effect is loaded into a submaster with a cue snapshot and another snapshot is executed with the same information for that submaster, the snapshot will not retrigger and interrupt playback for submasters where information has not changed. This will allow the use of the same snapshot filter setting even if submaster information is not changing.

For example, if a snapshot containing submasters 6-10 (see below) loads an effect and another cue is executed which contains the same snapshot, any of the submasters in this snapshot would not retrigger as long as the effect information is the same.

## Snapshot Data Window / Cue Snapshots List

The Snapshot Data window displays data for each snapshot. It also includes a list of Cue Snapshots.

#	Label	M1	M2	M3	CS	MC	PA	PB	PC	DW	SI	SW	Subs
Stored Snapshots													
6	MEDIA PROG	•	•	•			•	•	•				
7	window2 broke	•	•	•	•	•	•	•	•	•	•	•	1-30
8	8										•	•	1-10
10	clear...s 1-10										•	•	1-30
11	11									•			
12	12												
13	13												
14	14												
15	15												1-30
16	16	•											
17	17		•										
19	IFCB										•	•	1-10
20	20	•	•	•			•	•	•				
Cue Snapshots													
Cue	25												9-10
Cue	300												2-10
Cue	301										•		2-10
Cue	302										•		2-10
Cue	303										•		2-10



# MACROS

## Overview

A macro is a series of console events (e.g. button presses, display selections, windows opening) that have been recorded and stored by number. The sequence entered during a macro record operation will automatically be played back when the macro is recalled. Playback can be initiated by manual selection of the associated macro number or automated via cue sheet link instructions. Macros can speed up programming by providing a way to easily execute repetitive or complicated commands, or be used to automate playback sequences.

The time between events is always recorded and stored within the macro. The macro can be played back using this timing information or played back without so that events execute immediately "one after the other" instead of in real time. (The Timing feature can be turned on and off at the Macros window.)

Macros are stored in the Macro banks and can be accessed on any of the palettes. The screen capture below shows an example of the Macro Palette:

Macro	Bank 1				Page 1	Page 2	Page 3	Page 4	Page 5
1 Time Code Enable	2	3	4	5	6	7	8	9	10
11	12	13	14	15	16	17	18	19	20

**Note:** Macros are limited to a maximum of 200 events.

## Recording Macros

### Using Record Button

The quickest method for recording macros utilizes the palette and command-line keypad [Store] button.

When the [Macro Record] toggle button is pressed, the button will flash indicating that the recording function is enabled. Pressing a second time will disable the record function in the event you need to abort the action.

### Record a macro:

Step 1. At palette, select <Macro>.

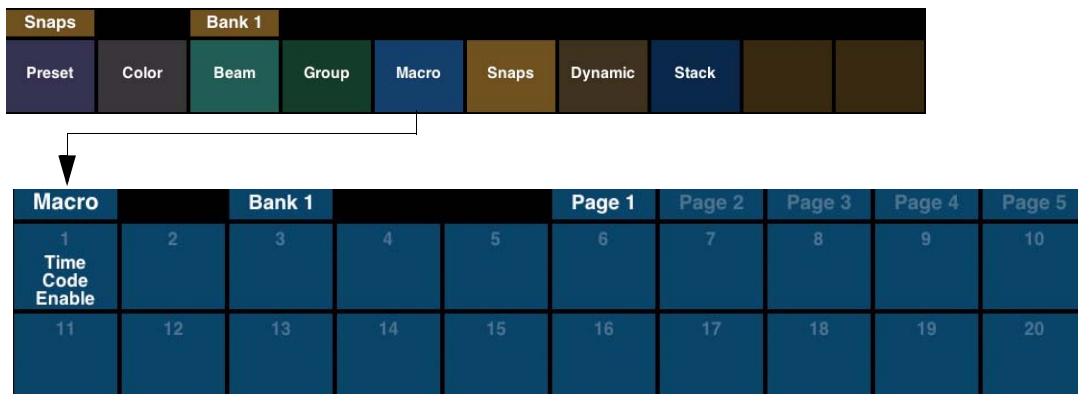

Macro Palette Buttons

Step 2. Press [Macro Record] toggle button. Button will flash.

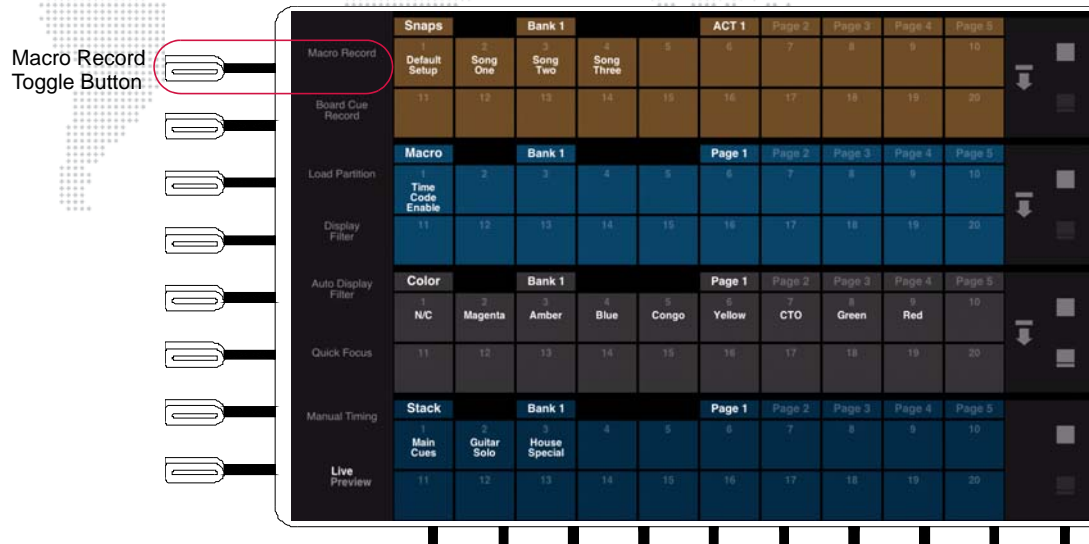

Step 3. Enter sequence of button presses, display selections, command-line entries, and/or software window selections.

Step 4. Press and hold [Store] while pressing <Macro Palette Button>. [Macro Record] toggle button will stop flashing.

### Label a macro:

When labeling, the name can be entered on the console touchscreen keyboard *or* computer keyboard.

Step 1. Press and hold [Label] while pressing <Macro Palette Button>.

Step 2. Enter alpha/numeric label.

Macro	Bank 1				Page 1	Page 2	Page 3	Page 4	Page 5
1 Time Code Enable	2	3	4	5	6	7	8	9	10
11	12	13	14	15	16	17	18	19	20

↑  
Macro Palette Button

### From Keypad

The macro record function can be initiated from the keypad. Timing can be specified using command-line entry.

When [Enter] is pressed, the [Macro Record] toggle button will flash indicating that the recording function is enabled (see previous page). Pressing the [Macro Record] toggle button after this will disable the record function in the event you need to abort the action.

### Record a macro:

Step 1. Press [Store] [Macro] [Enter].

Step 2. Enter sequence of button presses, display selections, command-line entries, and/or software window selections.

Step 3. Press [Store] [Macro] [n] [Enter] *or* [Store] [Macro] [n] [Label] [Enter] <xxxxxx> <Enter/Accept> - where n is the number of the macro palette where you wish to store the recorded sequence.

### Record a macro for timed playback:

- Step 1. Press [Store] [Macro] [Enter].
- Step 2. Enter sequence of button presses, display selections, command-line entries, and/or software window selections.
- Step 3. Press [Store] [Macro] [n] [Time] [Enter] - where n is the number of the macro palette where you wish to store the recorded sequence.

### Specify timing for a previously recorded macro:

- + [Macro] [n] [Time] [Enter] - where n is the discrete macro number.

### Copy/Move ranges of macros:

- + [Copy]/[Move] [Macro] [n] [Thru] [m] [At] [y] [Enter] - where n is the first macro in the range, m is the last macro in the range, and y is the new location for the range.

### Macro Recording Prompt

When using the [Store] button with the Macro palette, while macro recording is off, a Start Recording interface will pop-up.

#### To initiate recording (while macro recording button is off):

- Step 1. Press and hold [Store] while pressing a (Macro Palette Button). A Macro Recording screen will open.
- Step 2. To start the macro record, press (Start Recording) button.
- Step 3. Enter macro sequence as normal.

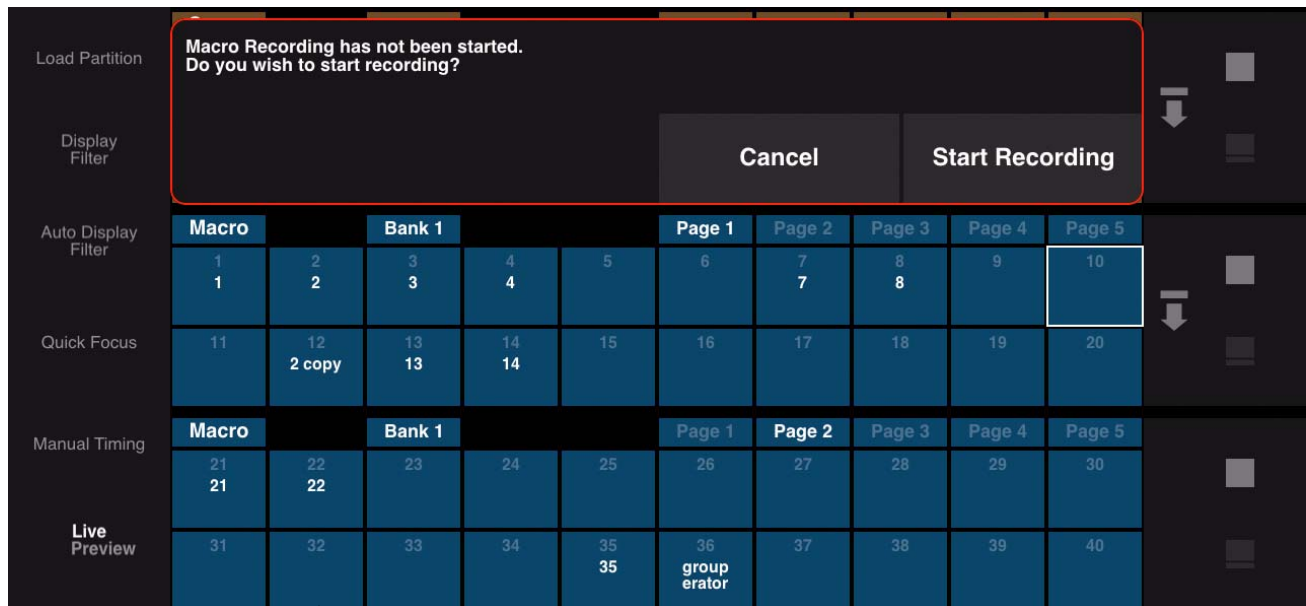

Macro Palette Button

- Step 4. Press and hold [Store] along with a macro palette button to finish recording.

## Macros Data Window

The Macros window can be used to view macro information and to edit macro timing.

The macro Delete, Replace, Punch In, and Insert features allow macro editing so that an entire macro does not have to be re-recorded in order to make a change.

### Access Macros window:

- Step 1. At **Data** menu, select **Macros**. Macros window will open.
- Step 2. If timing is desired, click in "T" column. A dot will appear in column indicating that real timing will be used when playing back macro. (Timing can be turned off at a later time by clicking in the "T" column again.)
- Step 3. If required, click arrow at left of **Steps** to open Steps drop-down window. Edit times as required.

Indicates that timing is active for the macro

Macro Number

Punch In

Delete

Replace

Insert

Timing information (This can be edited)

Macro	T	Label
1		Auto Display Filter
2	•	Clear Display Filter
3		+5
4	•	+10

Steps

Step	Time	Action
1	0.650	Store Function_Filter Template 19
2	4.665	Clear Function_Filter
3	2.215	Select Function_Filter Param Tilt Param Tilt
4	0.000	Change Param Pan Value By 0
5	11.890	Start Dynamics
6	0.000	Enable Encoder_Fan
7	0.555	Recall Dynamics Orientation Default 2 By 180
8	0.000	Recall Dynamics Orientation Default 2 By 180
9	0.650	Disable Encoder_Fan
10	19.995	Recall Function_Filter Template 19

Data Special Patch W

- Cue Data
- Cue Data
- Preset Data
- Color Palette Data
- Beam Palette Data
- Dynamics Palette Data
- Effects
- Sets
- Sequences
- Macros
- Snapshots
- Timecode Scripts
- Toggle Data Editing
- Revert to Defaults
- Cleanup Palette
- Copy Data...

### Delete a step:

- Step 1. Using trackpad, select step(s) to be deleted.
- Step 2. Click on "trash can" icon. Step(s) will be removed.

### Replace a step:

- Step 1. Using trackpad, select step to be replaced.
- Step 2. Click "replace" icon. (Console [Macro Rec] button will begin flashing.)
- Step 3. At front panel, perform replacement action. (The first action taken will replace the selected step and editing will end.)

### Replace all steps from Step X on (through remainder of macro):

- Step 1. Using trackpad, select last "good" step. (Steps after this selection will be replaced.)
- Step 2. Click "punch in" icon. (Console [Macro Rec] button will begin flashing.)
- Step 3. At front panel, perform new series of actions.

**Note:** Macro can be updated or re-stored as a new number.

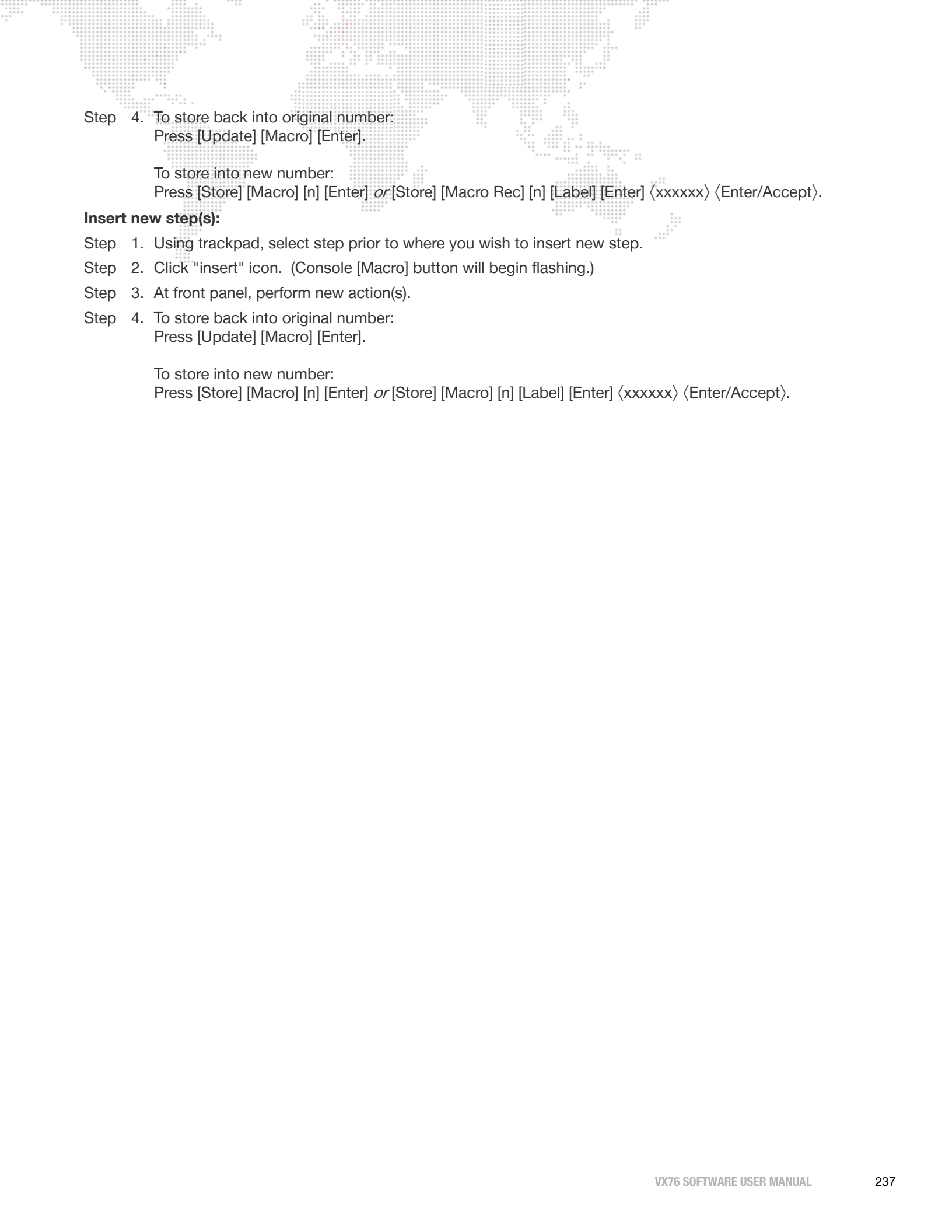

Step 4. To store back into original number:  
Press [Update] [Macro] [Enter].

To store into new number:  
Press [Store] [Macro] [n] [Enter] *or* [Store] [Macro Rec] [n] [Label] [Enter] <xxxxxx> <Enter/Accept>.

**Insert new step(s):**

Step 1. Using trackpad, select step prior to where you wish to insert new step.

Step 2. Click "insert" icon. (Console [Macro] button will begin flashing.)

Step 3. At front panel, perform new action(s).

Step 4. To store back into original number:  
Press [Update] [Macro] [Enter].

To store into new number:  
Press [Store] [Macro] [n] [Enter] *or* [Store] [Macro] [n] [Label] [Enter] <xxxxxx> <Enter/Accept>.

## Recalling Macros

Macros can be recalled using the palettes, Macro window, or by playing back the linked cue.

### Recall macro using the palette:

Step 1. At palette, select <Macro>.

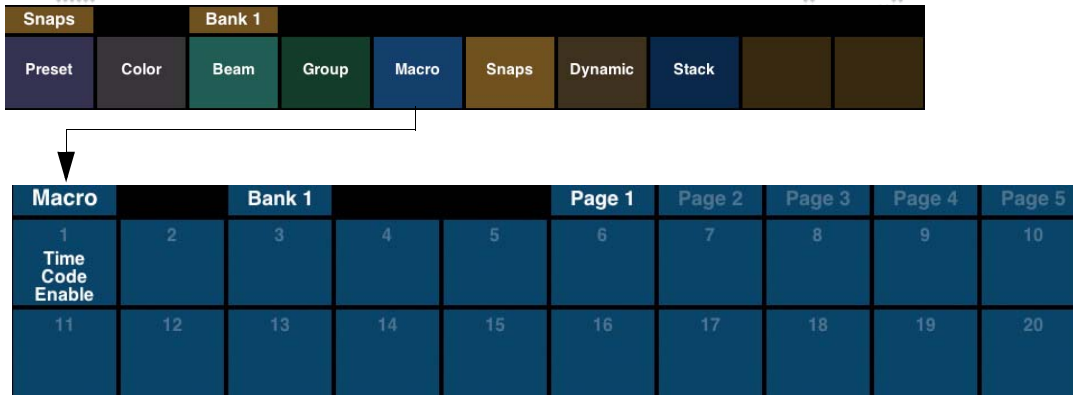

Macro Palette Buttons

Step 2. Press <Macro Palette Button>.

### Recall macro using command-line keypad:

- + Press [Macro] [n] [Enter] (where n is the discrete macro number).
- + Press [Macro] [Time] [n] [Enter] (where n is the discrete macro number) - recalls macro using time.

### Recall macro via link:

- + [Cue] [n] [Link] [Macro] [x] [Enter] - links Macro x to Cue n.
- + [Board Cue] [n] [Link] [Macro] [x] [Enter] - links Macro x to Board Cue n.

## Canned Macros

Canned Macros are provided to aid programmers in developing shows more rapidly. The Canned Macros, which can be found in the Macros Palette Bank 20 of the "Untitled" show file, were especially designed to work with the Century Palette window.

The Canned Macros are organized into logical groups of 20 in order to integrate effectively with the palettes. As with any macros, the Canned Macros can be moved and rearranged to suit any programmer's preferences.

---

**Note:** Some of the Canned Macros use Template 20 as a scratch pad to temporarily store filter settings, so that current filter settings will not be lost. If you plan to use the Canned Macros, it is recommended that you do not use Template 20, as it will not retain its settings.

---

---

**Note:** The palette Hi Lite macros use Color Palette 299 and 300. You will need to store your Hi Lite color into Color Palette 299 and the Background color into Color Palette 300.

---

The following is a list of all included Canned Macros by number:

**Table 10-1: Canned Macros**

No.	Name	Macro Description	Bank	Page
1901	Auto Display Filter	Turn on Auto Display Filter	20	1
1902	Load Display Filter	Loads Display Filter	20	1
1903	Clear Display Filter	Clears Display Filters	20	1
1904	Home	Home Luminaires	20	1
1905	Home Inten Full	Home Luminaires and puts intensity at full	20	1
1906	+5	Add 5% to Intensity	20	1
1907	+10	Add 10% to Intensity	20	1
1908	Sub 1 Hi Lite Off	Reselects channels and loads color from sub 1	20	1
1909	Sub 1 Hi Lite Forward	Takes luminaire selection and steps through each channel in ascending order, bumping each channel to white and then back to the cue in sub 1.	20	1
1910	Sub 1 Hi Lite Reverse	Takes luminaire selection and steps through each channel in descending order, bumping each channel to white and then back to the cue in sub 1.	20	1
1911	Mark Back 1 Cue	Takes the current selection and marks the channels in the previous cue	20	1
1912	Mark Back 2 Cues	Takes the current selection and marks the channels two cues back.	20	1
1913	Park	Parks selected channels	20	1
1914	Un-Park	Un-Parks selected channels	20	1
1915	Select Park	Selects parked channels	20	1
1916	-5	Subtract 5% from Intensity	20	1
1917	-10	Subtract 10% from Intensity	20	1
1918	Palette Hi Lite Off	Reselects channels and bumps the color to Color Palette 299.	20	1
1919	Palette Hi Lite Forward	Steps through channel selection in ascending order, bumping the current channel to the Hi lite color (color palette 299) and putting the other channels to the background color (color palette 300)	20	1
1920	Palette Hi Lite Reverse	Steps through channel selection in descending order, bumping the current channel to the Hi lite color (color palette 299) and putting the other channels to the background color (color palette 300)	20	1
1921	Up Time 0 Sec	Sets Up Time for current selection to 0 Seconds	20	2
1922	Up Time 1 Sec	Sets Up Time for current selection to 1 second.	20	2
1923	Up Time 2 Sec	Sets Up Time for current selection to 2 Seconds	20	2
1924	Up Time 3 Sec	Sets Up Time for current selection to 3 Seconds	20	2
1925	Up Time 4 Sec	Sets Up Time for current selection to 4 Seconds	20	2
1926	All Time 0 Sec	Sets time to all parameters for the current selection to 0 seconds.	20	2
1927	All Time 1 Sec	Sets time to all parameters for the current selection to 1 seconds.	20	2
1928	All Time 2 Sec	Sets time to all parameters for the current selection to 2 seconds.	20	2
1929	All Time 3 Sec	Sets time to all parameters for the current selection to 3 seconds.	20	2
1930	All Time 4 Sec	Sets time to all parameters for the current selection to 4 seconds.	20	2
1931	Down Time 0 Sec	Sets Down Time for current selection to 0 Seconds	20	2

**Table 10-1: Canned Macros (Continued)**

No.	Name	Macro Description	Bank	Page
1932	Down Time 1 Sec	Sets Down Time for current selection to 1 Seconds	20	2
1933	Down Time 2 Sec	Sets Down Time for current selection to 2 Seconds	20	2
1934	Down Time 3 Sec	Sets Down Time for current selection to 3 Seconds	20	2
1935	Down Time 4 Sec	Sets Down Time for current selection to 4 Seconds	20	2
1936	All Wheels 0 Sec	Sets time to 0 seconds to all wheels for current selection.	20	2
1937	Fade Parameter 1 Sec	Sets time to 1 seconds to all fading parameters such as color mix, intensity, beam, zoom, etc.	20	2
1938	Fade Parameter 2 Sec	Sets time to 2 seconds to all fading parameters such as color mix, intensity, beam, zoom, etc.	20	2
1939	Fade Parameter 3 Sec	Sets time to 3 seconds to all fading parameters such as color mix, intensity, beam, zoom, etc.	20	2
1940	Fade Parameter 4 Sec	Sets time to 4 seconds to all fading parameters such as color mix, intensity, beam, zoom, etc.	20	2
1941	Clear Time Delay	Sets time and delays for all parameters for the current selection to 0 seconds.	20	3
1942	Fanned Time 2 Sec	Sends Fanned time of 0 to 2 seconds to the current selection using the current fan.	20	3
1943	Fanned Time 4 Sec	Sends Fanned time of 0 to 4 seconds to the current selection using the current fan.	20	3
1944	Fanned Time 6 Sec	Sends Fanned time of 0 to 6 seconds to the current selection using the current fan.	20	3
1945	Fanned Delay 2 Sec	Sends Fanned delay of 0 to 2 seconds to the current selection using the current fan.	20	3
1946	Fanned Delay 4 Sec	Sends Fanned delay of 0 to 4 seconds to the current selection using the current fan.	20	3
1947	Fanned Delay 6 Sec	Sends Fanned delay of 0 to 6 seconds to the current selection using the current fan.	20	3
1948	Time Plus 1/2 Sec	Adds 1/2 second of time to the current selection.	20	3
1949	Time Minus 1/2 Sec	Subtracts 1/2 second of time from the current selection.	20	3
1950	Delay Plus 1/2 Sec	Adds 1/2 second of delay to the current selection.	20	3
1951	Cue Sheet	Brings up Cue Sheet Window to its current window state.	20	3
1952	Board Cue Sheet	Brings up Board Cue Sheet Window to its current window state.	20	3
1953	Media Window	Brings up Media Window to its current window state.	20	3
1954	Plan View Window	Brings up Plan View Window to its current window state.	20	3
1955	Luminaire Status Window	Brings up Luminaire Status Window to its current window state.	20	3
1956	Intensity Window	Brings up Intensity Window to its current window state.	20	3
1957	Century Palette	Brings up Century Palette Window to its current window state.	20	3
1958	Select Displays	Brings up Select Display Window to its current window state.	20	3
1959	Timing Filter Display	Brings up Timing Filter Display Window to its current window state.	20	3
1960	3d Graphic	Brings up 3D Graphic Window to its current window state.	20	3
1961	Inten Filter	Selects Intensity Filter	20	5
1962	Pan Tilt Filter	Selects Pan and Tilt Filter	20	5



**Table 10-1: Canned Macros (Continued)**

No.	Name	Macro Description	Bank	Page
1963	Pan Only Filter	Selects Pan Filter	20	5
1964	Tilt Only Filter	Selects Tilt Filter	20	5
1965	Color Mix Filter	Selects Magenta, Amber, and Blue Filter.	20	5
1966	Color Wheel Filter	Selects Color Wheel 1 Filter	20	5
1967	Beam Filter	Selects Beam 1 Filter	20	5
1968	Strobe Filter	Selects Strobe Filter	20	5
1969	Gobo Filter	Selects Fixed Gobo Filter	20	5
1970	Rotate Gobo Filter	Selects Rotating Gobo Wheel Filter	20	5
1971	Dynamic Rock Around	Selects Rock Around for the current channel and Filter selection.	20	4
1972	Dynamic Rock Above	Selects Rock Above for the current channel and Filter selection.	20	4
1973	Dynamic Rock Below	Selects Rock Below for the current channel and Filter selection.	20	4
1974	Bias Rock Around	Selects Bias Rock Around for the current channel and Filter selection.	20	4
1975	Bias Rock Above	Selects Bias Rock Above for the current channel and Filter selection.	20	4
1976	Bias Rock Below	Selects Bias Rock Below for the current channel and Filter selection.	20	4
1977	Auto Fit	Selects Auto Fit for the current channel and Filter selection.	20	4
1978	Forward	Selects Forward for the current channel and Filter selection.	20	4
1979	Reverse	Selects Reverse for the current channel and Filter selection.	20	4
1980	Stop All Dynamic	Stops all dynamics for currently channel selection.	20	4
1981	Offset 0 Degrees	Sets Offset to 0 Degrees for current channel and filter selection.	20	4
1982	Offset 90 Degrees	Sets Offset to 90 Degrees for current Channel, Fan and Filter selection.	20	4
1983	Offset 120 Degrees	Sets Offset to 120 Degrees for current Channel, Fan and Filter selection.	20	4
1984	Offset 240 Degrees	Sets Offset to 240 Degrees for current Channel, Fan and Filter selection.	20	4
1985	Offset 360 Degrees	Sets Offset to 360 Degrees for current Channel, Fan and Filter selection.	20	4
1986	Sine Wave	Selects Sine Wave for current Channel and filter selection.	20	4
1987	Triangle Wave	Selects Triangle Wave for current Channel and filter selection.	20	4
1988	Sawtooth Wave	Selects Sawtooth Wave for current Channel and filter selection.	20	4
1989	Reverse Sawtooth Wave	Selects Reverse Sawtooth Wave for current Channel and filter selection.	20	4
1990	Square Wave	Selects Square Wave for current Channel and filter selection.	20	4
1991	Bally Hoo Dynamic	Creates Bally Hoo for the current channel selection.	20	5
1992	Circle Wave Dynamic	Creates fanned circle wave for the current selection.	20	5
1993	Figure 8 Wave Dynamic	Creates fanned figure 8 for the current selection.	20	5
1994	Roller Wave Dynamic	Creates fanned Roller Wave for the current selection.	20	5
1995	Tilt Wave Dynamic	Creates fanned tilt wave for the current selection.	20	5
1996	Pan Wave Dynamic	Creates fanned Pan wave for the current selection.	20	5



**Table 10-1: Canned Macros (Continued)**

No.	Name	Macro Description	Bank	Page
1997	Intensity Dynamic	Creates fanned Intensity wave for the current selection.	20	5
1998	Multi M-A-B Dynamic	Creates a fanned multi color dynamic using color mix. (Mag, Amb, Blue)	20	5
1999	Solid M-A-B Dynamic	Creates a solid color dynamic using color mix. (Mag, Amb, Blue)	20	5
2000	Stop All Dynamic	Stops all dynamics for currently channel selection.	20	5



## BOARD CUES

---

### Overview

The board cue feature provides a method to record events on the console and play them back on command. Board cues are similar to macros, but are used primarily for recording playback operations in order to simplify complex cueing sequences for both spontaneous and "scripted" shows. The board cue feature allows recording of all types of playback operations, including submaster loading, executing Go commands, invoking filter states, pressing stop buttons, etc. It also allows simultaneous playback on multiple submasters for the purpose of automating or scripting a complete show. However, board cues will not record any previously established submaster modes that may be in effect when the board cue is recorded.

Board cues, like standard cues, are stored as numbers which can be randomly accessed for modification or playback at any time. The console can store up to 1,000 board cues, numbered from .01 to 999.99. Board cues can also be given alpha-numeric labels for identification.

The time between board cues is always recorded and stored within the board cue. The board cue can be played back using this timing information or played back without so that cues execute immediately "one after the other" instead of in real time. (The Timing feature can be turned on and off at the Board Cues window.) You can also loop board cues to play back the event over and over, either for a specified number of times or until it is manually stopped.

Several methods can be used to control board cue playback, including MIDI timecode, MIDI notes, and manual control.

---

**Note:** Board cues are limited to a maximum of 200 events.

---

## Board Cue Data Display

Board cue data can be displayed on the central touchscreen.

Options:

- + To view board cue information, press the <Board> button.
- + To return to the cue details, touch the cue number.

Cue List	Stack : Main	Cues:										Stack Separator
	Cue	Effect	Label	Mac	Snap	Link	AF	Out	Loop	Max		
Plan View	355.34	Hit 1						2.00		10.00		
	355.35	Hit 2						2.00		10.00		
	355.36	Hit 3						2.00		10.00		
	355.37	13	Hit 4	102	11		W 0.10	2.00		10.00		
	355.38	Fade Out					W 0.80	2.00		10.00		
	355.39	Restore						2.00		10.00		
	355.40	Hit 1						2.00		10.00		
	355.41	Hit 2						2.00		10.00		
	355.42	Hit 3						2.00		10.00		
Utilities	355.43	Hit 4					W 0.10	2.00		10.00		

Press Board button to display Board Cue information

Stack	Cue	Effect	Board
0	355.38	Fade Out	▲
Main			Cue
Board Cue	Label	Link	AF
100			
101	Go Home...	1	

## Recording Board Cues

### Using Record Button

The quickest method for recording board cues, utilizes the [Board Cue Record] toggle button and command-line keypad [Store] button. The button will flash indicating that the recording function is enabled. Pressing a second time will disable the record function in the event you need to abort the action.

#### Record a board cue using record button:

Step 1. Press [Board Cue Record] toggle button. Button will flash.

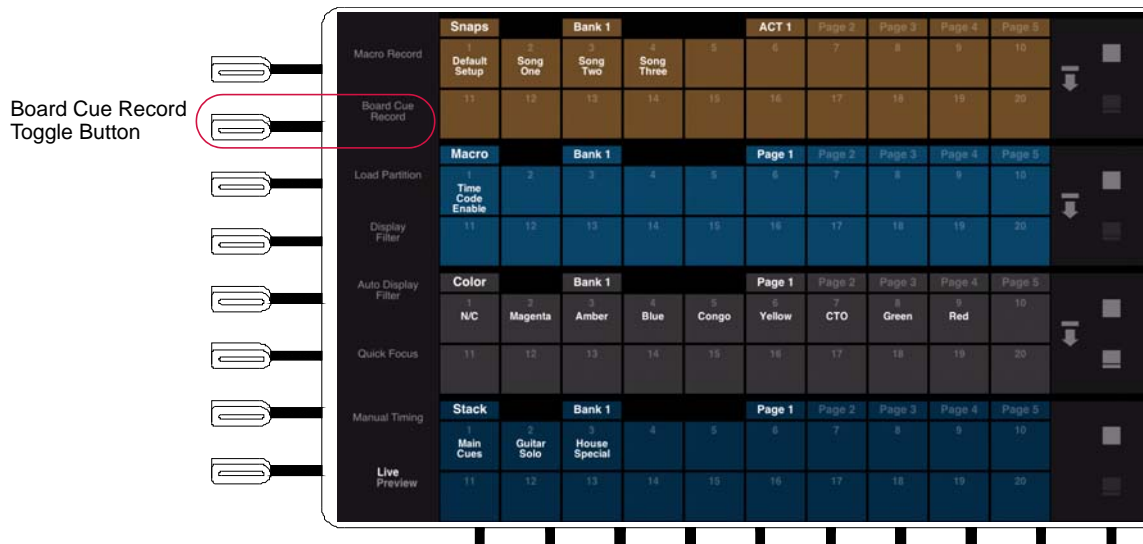

Step 2. Enter sequence of playback actions as required.

Step 3. Press [Store] [Board Cue] [n] [Enter] *or* [Store] [Board Cue] [n] [Label] [Enter] <xxxxxx> <Enter/Accept> - where n is a discrete board cue number. (Board Control [Go] button will light.)

Step 4. [Board Cue Record] toggle button will stop flashing.

### From Keypad

The board cue record function can be initiated from the command-line keypad. Board cue timing can also be specified at the keypad.

When [Enter] is pressed, the [Board Cue Record] toggle button will flash indicating that the record function is enabled. Pressing the [Board Cue Record] toggle button after this will disable the record function in the event you need to abort the action.

---

**Note:** Command-line shortcuts can be used when storing board cues just as with standard cues. Refer to "[Command-Line Shortcuts](#)" on page 255.

---

### Record a board cue using the keypad:

When labeling, the name can be entered on the console touchscreen keyboard *or* computer keyboard.

- Step 1. Press [Store] [Board Cue] [Enter].
- Step 2. Enter sequence of playback actions as required.
- Step 3. Press [Store] [Board Cue] [n] [Enter] *or* [Store] [Board Cue] [n] [Label] [Enter] <xxxxxx> <Enter/Accept> - where n is a discrete board cue number. (Board Control [Go] button will light.)

### Record a board cue with a linked attribute:

Board cues can be linked to other board cues, macros, or snapshots.

- Step 1. Press [Store] [Board Cue] [Enter].
- Step 2. Enter sequence of playback actions as required.
- Step 3. Press [Store] [Board Cue] [m] [Link] [Board Cue]\* [n] [Enter] - where m and n are discrete board cue numbers.

\* Substitute [Macro] or [Snap Shot] in place of [Board Cue] as required.

### Record a board cue with a wait time:

- Step 1. Press [Store] [Board Cue] [Enter].
- Step 2. Enter sequence of playback actions as required.
- Step 3. Press [Store] [Board Cue] [n] [Wait/Trail] [x] [Enter] - where n is a discrete board cue number. (Board Control [Go] button will light.)

## Deleting Board Cues

### Delete a board cue or a range of board cues:

- + [Delete] [Board Cue] [n] [Enter] - deletes the entire board cue.
- + [Delete] [Board Cue] [n] [Thru] [q] [Enter] - deletes a range of board cues.

## Recalling Board Cues

Board cues can be recalled and played back using the command-line keypad and Board Control [Go]. When a board cue is recalled, the [Go] button at the submasters panel will start flashing. Pressing [Go] will play back the board cue and any linked events. Pressing [Stop/Back] will pause the board cue autofollow time (not execution) until [Go] is pressed again wherein it will resume autofollow from the point at which it was stopped.

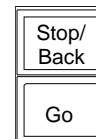

Board Control

---

**Note:** [Go] button will only flash while an autofollow is in process.

---

### Play back a board cue:

- Step 1. At keypad, press [Board Cue] [n] - where n is the discrete board cue number. (Board Control [Go] button will light.)
- Step 2. At front panel, press Board Control [Go] to initiate playback.

### Clear Board Cue indicators from display:

- + Recall a non-existent board cue. For example, [Board Cue] [0] [Enter] will clear display of any board cue information as long as Board Cue 0 is not a valid board cue.

## Board Cue Go/Back as Submaster 1 Go/Back

If no board cue is pending (by selecting a board cue via the command line or the board cue window), then the board cue [Go] and [Back] buttons are mapped to Submaster 1 Go and Back. If a board cue is pending, then the board cue Go/Back will perform normal board cue controls.

**Note:** To clear pending board cues, enter [Board Cue] [0] [Enter] on the command line.

## Board Cues Window

The content of board cues can be viewed in the Board Cues window. This window displays all recorded board cues in numerical sequence and provides data regarding linked events which would run during playback. Link attributes such as loops and autofollow types (wait and trail) are visible as well as the associated times (refer to "Special Cue Attributes" on page 250). Unless links are provided, which will run cues out of sequence, any playback sequences will observe the numerical order found in the sheet.

The Delete, Replace, Punch In, and Insert features allow editing so that an entire board cue does not have to be re-recorded in order to make a change. The Time column may also be edited.

### Access Board Cue Sheet:

- Step 1. At **Operation** menu, select **Board Cue Sheet**. Board Cue Sheet window will open.
- Step 2. If timing is desired, click in "T" column. A dot will appear in column indicating that real timing will be used when playing back board cue. (Timing can be turned off at a later time by clicking in the "T" column again.)

Operation	Data	Special
Cue Sheet		
Board Cue Sheet		
Plan View		⌘B
3D Graphic		⌘G
Luminaire Status		⌘S

Auto Follow type (wait, trail, or none)

Snapshot link

Cue link

Auto Follow time

Number of loop cycles

Toggles on/off timing feature so that Board Cue plays back with or without timing

Board Cue Number

Replace

Punch In

Insert

Delete

Steps which are part of the selected Board Cue

Timing information (This can be edited)

Step	Time	Action
1	4.185	Set Grand_Master Fader To 14
2	0.100	Set Grand_Master Fader To 74
3	0.100	Set Grand_Master Fader To 179
4	0.100	Set Grand_Master Fader To 255
5	2.080	Select Submaster 2
6	1.200	Load Submaster 2
7	0.605	Load Submaster 2
8	0.000	Go Submaster 2

**Delete a step:**

- Step 1. Using trackpad, select step(s) to be deleted.
- Step 2. Click on "trash can" icon. Step(s) will be removed.

**Replace a step:**

- Step 1. Using trackpad, select step to be replaced.
- Step 2. Click "replace" icon. [Board Cue Record] button will begin to flash.
- Step 3. At front panel, perform replacement action. (The first action taken will replace the selected step and editing will end.)

**Replace all steps from Step X on (through remainder of Board Cue):**

- Step 1. Using trackpad, select last "good" step. (Steps after this selection will be replaced.)
- Step 2. Click "punch in" icon. [Board Cue] button will begin flashing.
- Step 3. At front panel, perform new series of actions.

---

**Note:** Board Cue can be updated or re-stored as a new number.

---

- Step 4. Store by one of the following methods:
  - a. To store back into original number, press [Update] [Board Cue] [Enter].
  - b. To store into new number, press [Store] [Board Cue] [n] [Enter] *or* [Store] [Board Cue] [n] [Label] [Enter] <xxxxxx> <Enter/Accept>.

**Insert new step(s):**

- Step 1. Using trackpad, select step prior to where you wish to insert new step.
- Step 2. Click "insert" icon. [Board Cue Record] button will begin to flash.
- Step 3. At front panel, perform new step(s).
- Step 4. Store by one of the following methods:
  - a. To store back into original number, press [Update] [Board Cue] [Enter].
  - b. To store into new number, press [Store] [Board Cue] [n] [Enter] *or* [Store] [Board Cue] [n] [Label] [Enter] <xxxxxx> <Enter/Accept>.





11.

## ADVANCED CUE FEATURES

This chapter contains instructions for storing and modifying cues utilizing advanced console features. These instructions build on the basic store and playback instructions provided in the "[Basic Cues](#)" chapter on page 139.

- + SPECIAL CUE ATTRIBUTES
- + ADVANCED CUE STORING AND MODIFYING
- + CUE WINDOWS
- + CUE STACKS



## SPECIAL CUE ATTRIBUTES

---

### Cue Attributes Overview

In addition to parameter data, cues can contain the following special attributes:

- + Link
- + Loop
- + Auto Follow (AF) Type (Wait or Trail)
- + Auto Follow (AF) Time
- + Out Time

---

**Note:** These special attributes can also be applied to board cues as required.

---

#### *Guidelines:*

- + When a cue is stored, these cue attributes may be entered in any order.
- + If a cue is defined as an effect cue, then crossfade instructions may *not* be included in the cue contents.
- + The cue does not need to be active to change its data.
- + These special attributes can also be applied to cue ranges.
- + In all cases, these attributes may be defined using the command-line keypad or Cue/Board Cue Sheet window.

### Link

Link instructions can be stored with a cue. Link instructions allow cues to be run out of sequence by causing a different cue number to be loaded into the submaster's pending file when the cue that carries the link instruction is activated. In addition, link instructions may also be provided to snapshots, macros, and effects. (In the case of a linked effect, special conditions apply. See 'To Effects' below.)

If a wait or trail time is included with the cue data, automatic activation of the linked cue, snapshot, macro, or effect will occur when the wait or trail time has elapsed.

#### **Store a cue with a link to another cue:**

- + [Store] <Cue> [n] [Link] <Cue> [x] [Enter] - upon playback of Cue n, the "linked" cue (x) would be loaded into the same submaster for manual activation.

#### **Link an existing cue to another cue:**

- + [Cue] [n] [Link] [x] [Enter] - links Cue n to Cue x.

#### **Remove a link from a cue:**

- + [Cue] [n] [Link] [Enter] - removes the link instruction from Cue n.

#### **Link a snapshot to a cue:**

- + [Cue] [n] [Link] [Snap Shot] [x] [Enter] - links Snapshot x to Cue n.

#### **Link a snapshot to the active cue (short cut):**

- + [Link] [Snap Shot] [x] [Enter] - links Snapshot x to current active cue.

#### **Link a cue to a macro:**

- + [Cue] [n] [Link] [Macro] [x] [Enter] - links Macro x to Cue n.

**Tip** ⇨ To link another cue to the currently selected cue, press [Link] [n] [Enter] - where n is the linked cue.



To link a snapshot, macro, or effect to the currently selected cue, press [Link] [Macro\*] [n] [Enter] - where n is the number of the macro you wish to link.

\* [Snap Shot] or [Effect] can be used instead of [Macro].

## To Effects

A cue can either have data or recall an effect, but not both. When an effect is linked to a cue, the effect will be recalled when that cue number is played.

### Link an effect to a cue:

- + [Cue] [n] [Link] [Effect] [x] [Enter] - links Effect x to Cue n.

## Loop

Loop instructions are used in combination with link instructions to replay a sequence multiple times.

When a cue with a link and loop instruction is played back, the linked cue will automatically be played back on the same submaster and then the original cue would be reloaded and the sequence would repeat as defined by the loop number. After the defined number of loops, the submaster will automatically load the next sequential cue into the submaster's pending file, activating the next cue based on autofollow for loop or sequential cue.

**Tip** ⇨ Loops should be defined on the last cue of a sequence.

### Store a cue with link and loop instructions:

- + [Store] <Cue> [n] [Link] [m] [Loop] [x] [Enter] - links Cue n and Cue m with a loop of x times.

### Add a loop to an existing linked cue:

- + [Cue] [n] [Loop] [x] [Enter] - Cue n and its linked cue will loop x times.

### Remove a loop instruction from a linked cue:

- + [Cue] [n] [Loop] [Enter].

**Tip** ⇨ To add a Loop instruction to the currently selected cue, press [Loop] [n] [Enter] - where n is the number of desired loops.

## Wait/Trail Time

Wait or Trail time instructions may be stored into a cue to control the start of subsequent or linked events (refer to "Link" on page 250).

Wait is a timing attribute which causes the next event to be automatically executed after the wait time has elapsed. The wait time begins counting from the moment the cue is executed.

Trail is a timing attribute which causes the next event to be automatically executed after the trail time has elapsed. The trail time begins counting from the moment the cue has completed.

### Guidelines:

- + A cue can have either a Wait or a Trail instruction, but not both.
- + If no linked event is specified (via a Link instruction), then the subsequent cue in the cue list will execute after the wait/trail time has elapsed.
- + If a linked event is specified, the linked event will execute after the wait/trail time has elapsed.

---

**Note:** In the following examples, Trail could be used instead of Wait. Click [Wait/Trail] once for Wait and twice for Trail.

---

### Store a cue with a wait/trail time:

+ [Store] <Cue> [n] [Wait/Trail] [m] [Enter] - stores Cue n with a wait time of m.

### Store a cue with a link and a wait/trail time:

+ [Store] <Cue> [n] [Link] [x] [Wait/Trail] [m] [Enter] - stores Cue n and provides an out of sequence link to Cue x with a wait time of m.

### Add a wait/trail time to an existing cue:

+ [Cue] [n] [Wait/Trail] [x] [Enter] - adds a wait time of x for Cue n.

### Add a wait/trail time to a range of cues:

+ [Cue] [m] [Thru] [t] [Wait/Trail] [x] [Enter] - adds the specified wait time (x) to all of the cues in the specified cue range (m thru t).

### Remove a wait/trail time from a cue:

+ [Cue] [n] [Wait/Trail] [Enter] - removes the wait time from the specified Cue n.

### Remove a wait/trail time and link from a cue:

+ [Cue] [n] [Link] [Wait/Trail] [Enter] - removes both the wait and link instruction for the specified Cue n.

### Remove a wait/trail time from a range of cues:

+ [Cue] [n] [thru] [t] [Wait/Trail] [Enter] - removes the wait or trail time from the specified cue range (n thru t).

**Tip** ⇨ To add a wait/trail time to the currently selected cue, press [Wait] [n] [Enter] - where n is the desired time.

\* Click [Wait/Trail] once for Wait and twice for Trail.

## Global Cue Time

Cue Time provides a simplified option for parameter timing. If there is a Cue Time associated with a cue, any fixture parameter that has a zero (default) time value will use the cue time instead when the cue is recalled. If the parameter has a non-zero time, it will override the global cue time.

The [Cue/Out Time] key in the upper right of the command keypad is used to enter a Cue Time:

- + The first click on the button will be Cue Time, a double-click will be Out Time. (See Out Time on next page.)
- + If Cue Time is already entered on a command, the second press of the button will automatically show as Out Time.



### Store a cue with a cue time:

[Store] <Cue> [n] [Cue/Out Time] [x] [Enter] - stores Cue n with a global cue time of x.



## Out Time

Out Time instructions may be stored into a cue. An Out Time will provide a "fade to no intensity level" instruction to any luminaires that are "going *inactive*" in a cue. Out Time also provides the time value that luminaires are to fade to *inactive* in the event the submaster is deselected.

The console has a setting for a default Out Time, which is stored into all new cues where a different time is not specified. The default setting is 3 seconds, but can be changed universally in the Settings window. Refer to "[Settings Window](#)" on page 306 to change the default Out Time.

The [Cue/Out Time] key in the upper right of the command keypad is used to enter an Out Time:

- + The first click on the button will be Cue Time, a double-click will be Out Time.
- + If Cue Time is already entered on a command, the second press of the button will automatically show as Out Time.

### Store a cue with an out time:

- + [Store] <Cue> [n] [Cue/Out Time] [Cue/Out Time] [x] [Enter] - stores Cue n with an out time of x.

### Add an out time to a range of cues:

- + [Cue] [m] [Thru] [n] [Cue/Out Time] [Cue/Out Time] [x] [Enter] - adds an out time of x to the range of cues m through n.

### Reset a cue's out time back to zero:

- + [Cue] [n] [Cue/Out Time] [Cue/Out Time] [Enter].

**Tip** ⇨ To add an out time to the currently selected cue, press [Cue/Out Time] [Cue/Out Time] [n] [Enter] - where n is the desired out time.

## ADVANCED CUE STORING AND MODIFYING

---

### How Faders Affect Intensity

Previously, intensity states were discussed in relation to cue store operations (refer to "Intensity States" on page 140). In addition to these four intensity states, the Grand Master fader, Black Out feature, and submaster faders can affect playback intensity levels. When used in combination with the manual control intensity encoder, the Grand Master fader and any selected submaster faders all play a part in the final intensity output level by a proportional calculation.

### Grand Master/Black Out

The console provides two methods for mastering overall intensity output: the Grand Master fader and its associated [Black Out] button. The Grand Master fader can be used to proportionally master the intensity output. The [Black Out] button, when engaged, sets all intensities to *zero*. However, neither the Grand Master nor [Black Out] button settings are stored into a cue/preset.

*Example:*

Cue Store Scenario (with all submasters deselected):

Selected channels have an intensity value of 100%.

Grand Master fader is set at 0%.

Channels are stored into the cue with an intensity value of 100%.

---

**Note:** The [Black Out] button is only available on V476 and V676 front panels.

---

### Submaster Faders

Submaster faders can affect the intensity output of selected luminaires prior to the Grand Master contribution, provided the submaster is currently selected. Calculation of the final intensity output when including submaster faders becomes more complex.

A way to visualize the impact of encoder/fader settings on intensity is to open the Luminaire Status window and view the resulting level changes as you move each fader. (As with the two examples given on the previous page, these instructions are intended to help show the relationship of intensity controls since it would be impossible to provide examples for all possible combinations.)

Step 1. At **Operation** menu, select **Luminaire Status**.

Step 2. Select required channels.

Step 3. Using Intensity encoder or [Full] button, bring intensity levels to 100%.

Step 4. Select a submaster by pressing its [Select] button.

Step 5. Move Intensity encoder, submaster fader, and Grand Master fader in various combinations and view the intensity level changes in Luminaire Status window's Intensity column.

Operation	Data	Special
Cue Sheet		
Board Cue Sheet		
Plan View		⌘B
3D Graphic		⌘G
Luminaire Status		⌘S
Tracking Changes		⌘5
Intensity		⌘I
Timecode		
Palettes		

This will give you an idea of how these faders and encoders work together to calculate a final intensity level for the selected luminaires. This is important because cues/presets can be stored with intensity values.

## Command-Line Shortcuts

The command-line feature has several built-in shortcut and convenience capabilities which can be used to speed up and simplify operations.

**Tip** ⇨ Some shortcuts have been indicated so far throughout the manual with the graphic shown to the left of this text. These shortcuts, along with additional ones, are collected here.

### Using [+] with [Store]

The [+] button can be used to increment the store target by a predetermined increment value (default = +1).

#### Using [+] with a +1 increment value:

- + Pressing [Store] [1] [Enter] will store Cue 1. Pressing [Store] [+] [Enter] will store Cue 2. Pressing [Store] [+] [Enter] will store Cue 3, etc.

#### Using [+] with a +0.1 increment value:

- + Pressing [Store] [1] [Enter] will store Cue 1. Pressing [Store] [+] [.1] [Enter] will store Cue 1.1. Pressing [Store] [+] [Enter] will store Cue 2.2, etc.



Increment Value Indicator

---

**Note:** The increment value is also displayed in the Encoders window. Refer to "[Encoders HUD Window](#)" on page 70.

---

### [Store] [Store]

This command-line entry can be substituted for the standard cue store entry.

- + Press [n] [Store] [Store] to store Cue n.

### Submaster Load

A cue specified at the keypad can be immediately loaded and played back in an empty submaster.

- Step 1. At keypad press [cue number]. (Must be valid cue number.)
- Step 2. At empty submaster press [Go] and then [Select].

## Cue Store Target

Pressing [Store] [Enter] always defaults the store command to the last selected cue. (This cue is displayed in the command-line display.)

Selected Cue  
[Store] [Enter] will always re-store this cue



Additionally, when working with decimal cues, it is not necessary to re-enter the leading cue number.

Examples:

- + [Store] <Cue> [5] [Enter] = store Cue 5
- + [Store] <Cue> [5] [.] [3] [Enter] = store Cue 5.3
- + [Store] <Cue> [.] [7] [Enter] = store Cue 5.7

## Cue Attribute Target

For the currently selected cue (see illustration above), attribute instructions can be applied without re-specifying the cue target.

Examples:

- + To link another cue to the currently selected cue, press [Link] [n] [Enter] - where n is the linked cue.
- + To link a snapshot, macro, or effect to the currently selected cue, press [Link] [Macro\*] [n] [Enter] - where n is the number of the macro you wish to link.
- + To add a wait/trail time, out time, or loop to the currently selected cue, press [Wait/Trail] [n] [Enter] - where n is desired time or number of loops.

\* [Snap Shot] or [Effect] can be used instead of [Macro].

\* also [Cue/Out Time] or [Loop].

## Miscellaneous Shortcuts

- + Holding down [Clear] will clear an entire unterminated command line.
- + Pressing and holding [Next] while pressing [Last] will reselect the original channel range or group.

## Creating Cue Numbers without Storing Data

It is possible to create and label cues without storing data. To do this is, store a cue while all luminaires are *inactive* or off-line.



## Locating Stored Cues

In order to verify if a certain cue number exists or to locate nearest stored cue numbers, a shortcut can be used.

### Locate cue number:

At keypad, press [Cue] [n] [Enter] for cue number you wish to verify. One of two things will happen:

- + If the cue exists, its number and label will be displayed in the command-line display.
- + If a cue by that number does not exist, "no cue" will be displayed. At command-line display, press Cue Forward or Cue Backward arrows. The next higher or lower cue numbers (nearest the cue number you entered) will appear in the display.

Cue List	Cue	Effect	Label	Mac	Snap	Link	AF	Out	Loop	Max	Stack Separator
	684		End Look					2.00		7.00	
Plan View	685		Fade Out			1700	W 4.00	2.00		4.00	
	===== Me Against The Music =====										
	700		Cue Up					2.00		4.00	
	700.10		Blue Fade Up					2.00		1.00	
	700.20		Floor Fade In					2.00		1.00	
	700.30		BAd Boys Out					2.00		1.00	
	701		Floor Fade Slowly					2.00		50.00	
	702		Floor Chs					2.00		50.00	
	703		All Chase Verse					2.00		50.00	
Utilities	704		Strobe Break					2.00		50.00	

Stack / Separator Selection

Cue Forward

Cue Backward

## Freeze State Cues

A Freeze state may be stored as a cue.

- + At submaster touchscreen, press and hold **Freeze** while choosing a submaster. ("Choose" is activated by touching the specific submaster on the touchscreen.)

Refer to "**Freeze**" on page 292 for more information.



## Update

The Update feature is used to store modified channels back into their source cues. Any channels that have been modified from a cue active in a submaster will update those changes into the cue when a general Update or Update for that specific cue is commanded. In addition, new channels can be added into a cue with Update, if the Update command is targeted to a specific cue and the channels have been made active and are not in other active cues.

### *Guidelines:*

- + Any rate modifications will affect the stored time values accordingly.
- + Unexpected behavior can occur with updates involving intensity if the submaster and Grand Master faders are not at full. Refer to "[Store, Update, and Selective Store with Submasters](#)" on page 262.
- + Update is intended for active cues only. To add sections of the live stage output to inactive cues, use the Selective Store command (refer to "[Selective Store](#)" on page 260).
- + Any channel transferred to an independent submaster or parked in patch will not be updated. All other cue data remains as originally set.

---

**Note:** Unlike Selective Store, Update commands are not routed through the Channel Select panel and the filter settings.

---

### **Update a cue:**

- + [Update] <Cue> [n] [Enter] - updates Cue n with only those channels that were receiving their instructions from that cue.

### **Update multiple cues:**

- + [Update] [Enter] - updates all modified channels in their source cues. Any channels that had no source cue would not be stored.

### **Update a preset:**

- + [Update] [Preset] [Enter] - updates all modified channels in their source cues and preset(s). Any channels that had no source cue would not be stored.

### **Update a preset in a specific cue:**

- + [Update] [Cue] [n] [Preset] [Enter] - updates Cue n and its preset(s) with only those channels that were receiving their instructions from that cue.

### **Undo (reverse) an Update command:**

- + [Undo] [Enter] - reverses the store portion of the most recent undo (any new channels that were stored into the cue will be removed from the cue). The source cue updates that were performed will *not* be undone.



## Track and Fill

Track/Fill can be used to update multiple cues. A Track edit will update all current parameter values into the given cue, and into all following cues in the cue sheet as long as the cue parameter value matches the original value in the given cue, or until reaching a block in the cue sheet. A Fill edit will extend the updates in both directions in the cue sheet (adhering to the above rules).

### Guidelines:

- + Parameter values will track independently of time and dynamics. For example, a value change will continue tracking even if the time changes from the original cue.
- + Timing changes will track with the parameter value and will stop when the parameter value changes (even if the parameter value was not edited).
- + Dynamic attributes will track as if they were a separate parameter, if the dynamic type does not change, regardless of the base parameter value. For example, changing the dynamic rate for a ballyhoo will track through successive ballyhoo dynamics that have the same original rate. The track will stop when a cue is encountered that has no dynamic or a different type of dynamic, *or* if the cue has a different dynamic rate than the original cue.
- + Tracking, like Update, is done without respect to channel selection or the function filter.
- + Track and Fill operates numerically through the cue sheet and will not follow links.

### Examples of track editing using keypad:

- + [Track/Cue Only] <Cue> # - tracks from cue.
- + [Track/Cue Only] <Cue> # [Preset] - tracks from cue and updates source presets.
- + [Track Back] <Cue> # - fills backwards from cue.
- + [Update] [Track/Cue Only] [Enter] - updates tracking.

Press and hold [Track/Cue Only] while choosing a submaster *or* [Track/Cue Only] [Track/Cue Only] while choosing a submaster. ("Choose" is activated by touching the specific submaster on the touchscreen.)

### Examples of fill editing using keypad:

- + [Update] [Track/Cue Only] [Track Back] [Enter]

### To add or remove a block using keypad:

- + [Cue] # [Block/UnBlk] – inserts block at cue.
- + [Cue] # [Block/UnBlk] [Block/UnBlk] – removes block at cue.

### To add a block using Cue Sheet window:

- + At Cue Sheet window, add an editable Block column to set or clear cue blocks.



## Selective Store

The Selective Store feature is used to modify or add parameter data to a cue, preset, or beam state for specified channels (*active* or *inactive*). For example, with this function you could modify a cue's color parameters, while leaving all other parameter data intact for a particular cue or a range of cues.

**Tip** ⇨ Selective Store is most useful when you know the exact range of cues to be modified.

---

**Note:** Unlike Update, Selective Store commands are routed through the Channel Select panel and the filter settings.

---

### Selective Store new data for a particular parameter in a cue:

- Step 1. Select required channels.
- Step 2. At touchscreen, modify a parameter(s) as required. For example, color.
- Step 3. Press [Sel Store] <Cue> [n] [Enter]. The new color parameters will be stored in place of the old color parameters, but all other parameter data will remain the same.

### Selective Store new data for a particular parameter in a range of cues:

- Step 1. Select required channels.
- Step 2. At touchscreen, modify a parameter(s) as required. For example, color.
- Step 3. Press [Sel Store] <Cue> [n] [Thru] [m] [Enter]. The new color parameters will be stored in place of the old color parameters, but all other parameter data will remain the same.

---

**Note:** As a caution when altering parameters for more than ten cues, a confirmation window will open.

---

### Selective Store all selected channels into a cue:

- Step 1. Select required channels.
- Step 2. Using manual control, set parameters as required.
- Step 3. At touchscreen, set filters as required.
- Step 4. Press [Sel Store] <Cue> [n] [Enter]. All selected channels are re-stored into the specified cue at current stage levels. Only those parameters allowed by the filter settings are affected.

### Modify a preset using Selective Store:

- Step 1. At touchscreen display, modify filter settings as required.
- Step 2. Select required channels.
- Step 3. Press and hold [Sel Store] while pressing <Preset Palette Button> or [Sel Store] [Preset] [n] [Enter] (where n is the discrete Preset number).

### Undo (reverse) a Selective Store command:

- + [Undo] [Enter] - reverses the last store/update/delete command.



## Selective Recall

The Selective Recall feature is used to recall specific parameter data from specified channels (*active or inactive*) in a cue, preset, or beam state.

### Guidelines:

- + Selective Recall routes through the filter settings.
- + If Timing is selected at the touchscreen filter, then the parameter *and* all timing information will be recalled (making that the current state).
- + If Timing is *not* selected at the touchscreen filter, then only the parameter will be recalled.
- + If Manual Timing is enabled (refer to "**Manual Timing**" on page 198), then the current time information in the luminaires will be recalled. (For example, if focus has a time of 10 seconds and color has a time of 5 seconds, then the luminaire will recall the parameters using those individual times.)

---

**Note:** The system assumes that data to be recalled is from a cue. As such, use of the <Cue> button is optional.

---

### Recall stored cue data:

- Step 1. Using Function Filter, select parameters to be recalled. (Refer to "**Function Filter**" on page 93.)
- Step 2. If timing is desired, press [Man Time]. Recalled parameters will change in the luminaire's current time settings.
- Step 3. Select channel(s) as required.
- Step 4. Press [Recall] <Cue> [m] [Enter]. All stored data will be recalled from the specified cue (m) for the selected luminaires, as dictated by the selections on the filters.

### Recall stored preset data:

- Step 1. Using Function Filter, select parameters to be recalled. (Refer to "**Function Filter**" on page 93.)
- Step 2. If timing is desired, press [Man Time]. Recalled parameters will change in the luminaire's current time settings.
- Step 3. Select channel(s) as required.
- Step 4. Press [Recall] [Preset] [x] [Enter] *or* [Recall] <Preset Palette Button>. All stored data will be recalled from the specified preset (x), as defined by the selections on the filters.

## Undo a Delete Command

In addition to reversing Store and Update commands, the Undo feature can be used to reverse a Delete command.

### Undo (reverse) a Delete command:

- + [Undo] [Store] [Enter] - reverses the last store/update/delete command.



```
> Undo Store
(cue)
```

## Manual Undo To Recorded State

When in a cue, with selected fixtures that have manual changes, press [Undo] [Channel] [Enter] to send the channels back to their cue state.

## Modifying Cues in a Submaster

Cues can also be modified and re-stored while active in a submaster. The Store, Selective Store, and Update commands can be performed by using them in combination with the submaster "choose" feature. (Refer to "Submaster Choose" on page 280 for more information.)

### Guidelines:

- + When modifying a cue in a submaster, the modified cue data is automatically loaded into the associated submaster. (Because the loaded cue is subject to altering by the fader setting, unexpected behavior can occur when that fader setting is less than full. See "Unexpected Behavior" below.)
- + Only channels receiving instructions from the cue being modified will be changed.

## Store, Update, and Selective Store with Submasters

After a cue has been loaded and played back in submaster, its channels can be modified and re-stored using standard cue store commands.

For more information, refer to "Update" on page 258 and "Selective Store" on page 260.

### Modify a cue in a submaster:

- Step 1. Run cue in submaster.
- Step 2. Using manual control, modify parameters as required.
- Step 3. Press and hold [Update]\* while choosing a submaster. ("Choose" is activated by touching the specific submaster on the touchscreen.)

\* [Store] or [Sel Store] can be used instead of [Update].

## Unexpected Behavior



When a cue is re-stored while active in a submaster, unexpected behavior can occur if any selected submaster's fader is set below full. This happens as a result of two factors. First, when the intensity is stored at a lower level as a result of a fader, then the updated cue is automatically loaded back into the submaster, it will immediately be affected (for the second time) by the fader setting causing a further reduction in intensity output. Second, if more than one submaster is selected, the Highest Takes Precedence (HTP) protocol must be considered. If a cue, active in the first submaster, is updated to an intensity level below that of the second submaster, then after the cue is automatically reloaded to the submaster, it will be overridden by the higher value of the second submaster (which now controls the intensity output as a result).

## Submaster Direct Mode

To assist in updating or re-storing cues, it is possible to have the command-line track the sequence of cues being executed in a submaster. When Submaster Direct mode is active, cues will advance according to the sequence being played back in the specified submaster.

Effect	Label	Mac	Snap	Link	AF	Out	Loop	Max	Stack Separator
	Strobe Break Down							10.00	
	Chase Center							10.00	
Military Intro									
	Hold Up							4.00	
	Count 1							4.00	
	Pause							4.00	
	Count 1 Resume							4.00	
	Beat In							4.00	
	Hit 1							4.00	
	Hit 2				W 0.20			4.00	
	Resume							4.00	

Sync Information

Press both arrows together to resync

There are two methods of initiating this mode:

- + At command-line keypad, press [Cue] [Sub] [n] [Enter] - where n is the desired submaster number.
- + At command-line keypad, press and hold [Cue] while choosing a submaster. ("Choose" is activated by touching the specific submaster on the touchscreen.)

Once the mode has been activated, the cue title will show "Synced to sub #". Any advances in the cue sequence at the submaster will automatically advance the current cue. If you wish to make changes to any cue, then that cue number is already in the display when you go to store the cue again (after making changes).

There are two options for turning off the Submaster Direct mode (this will unlock all submasters):

- + Enter the command-line sequence [Cue] [Sub] [0] [Enter] to turn off Direct mode on *all* submasters.
- + Press and hold [Cue] while pressing "choose" area on any submaster that is in Direct mode to turn off Direct mode on *all* submasters.

## Resync:

When in Direct mode, it is sometimes useful to bring the submaster cue back as the current cue *after* other cues have been selected. When the cue selection is synchronized to a submaster and another cue is manually selected, the cue selection can be re-synched to the submaster by pressing the Cue Forward and Cue Backwards arrows together at the same time, or touching the <Resync to sub #> label.

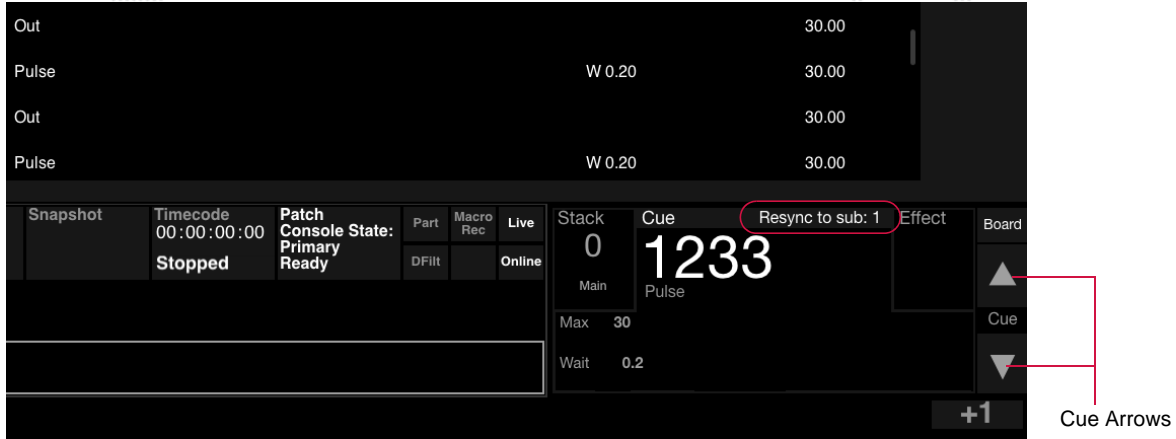



# CUE WINDOWS

## Cue Sheet

Cue sheet data can be viewed and edited in the Cue Sheet window. The cue sheet displays all recorded cues in numerical sequence and provides data regarding linked events which would run during playback. Link attributes such as loops, auto follow types (wait and trail), cue times, and out times are visible. Unless links are provided, which will run cues out of sequence, any playback sequences will observe the numerical order found in the cue sheet.

**Note:** A Cue Stack toolbar will be visible when a Cue Stack is selected. Refer to "Cue Stacks" on page 273 for complete instructions on this window feature.

### Access Cue Sheet:

- Step 1. At **Operation** menu, select **Cue Sheet**. Cue Sheet window will open.
- Step 2. Enter or edit data as required.

Operation	Data	Special
Cue Sheet		
Board Cue Sheet		
Plan View		⌘B
3D Graphic		⌘G
Luminaire Status		⌘S
Tracking Changes		⌘5

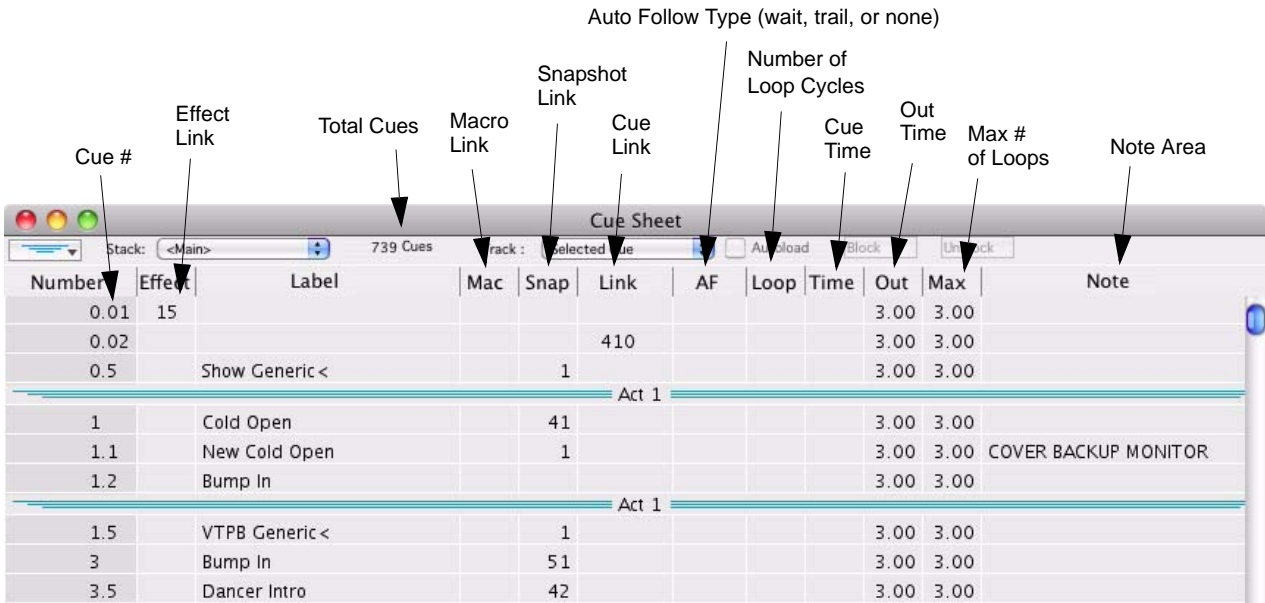

### Forward/Backward Buttons

It is possible to move forward or backward through the cue list in the command-line display by pressing the advance buttons.

- + At command-line display, press Cue Forward and Cue Backward arrows. Cue numbers shown in command-line display will respond accordingly.

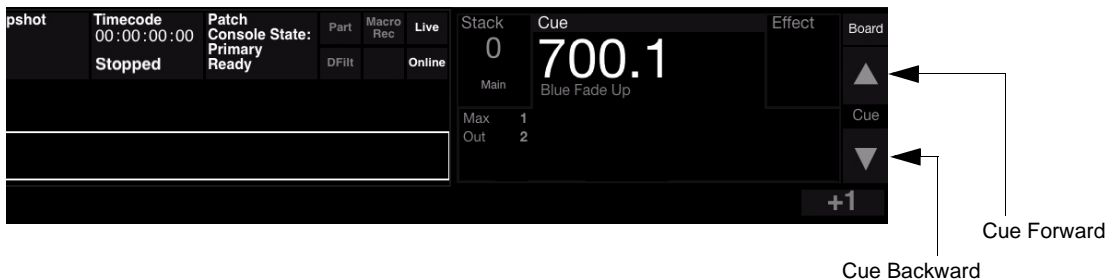

## Separators

Separators can be inserted into the Cue Sheet list in order to organize certain groups of cues as necessary. The separators can then be used as markers to quickly access the first cue of each group.

Separator Pop-up Menu -  
Used to add, delete or scroll list to  
any separator by choosing name.

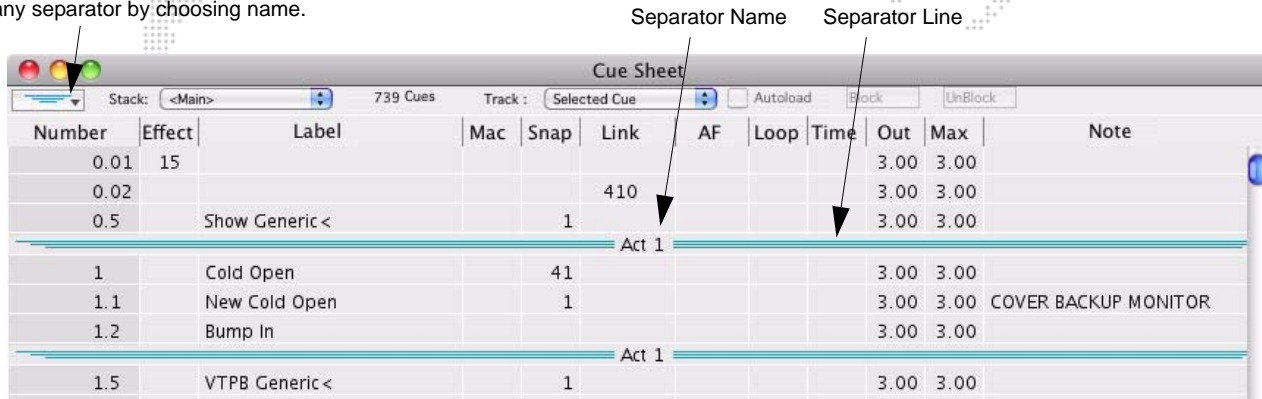

### Insert a separator:

- Step 1. At Cue Sheet, use cursor to select cue above where you wish to insert separator.
- Step 2. At Cue Sheet pop-up menu, select **New Separator**. A separator will be inserted.
- Step 3. Type name of separator.
- Step 4. Press [Enter].

### Go to specified separator:

- + At Cue Sheet window, select separator by name from pop-up menu. Cue Sheet will scroll to beginning of separator line.

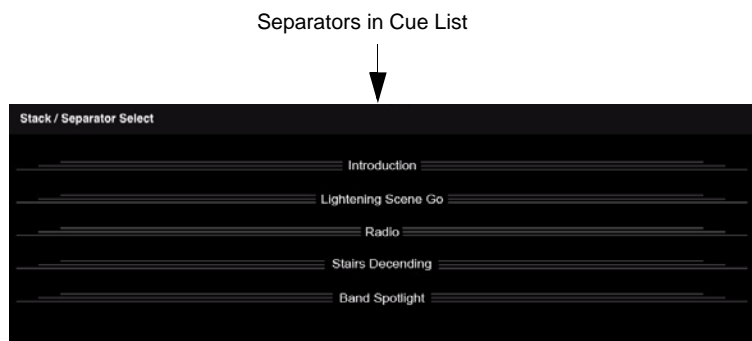

## Renumbering Cues

The cue number field is editable.

**Note:** The Move function also effectively renumbers cues. (Refer to "Copy/Move" on page 203).

## Submasters Track Mode

The submaster Track mode, specifies which submaster the cue sheet will follow. The window selection will reflect the active cue in the submaster selected at the Track pull-down menu. When cues are loaded or advanced in that submaster, the Cue Sheet window will reflect the changes.

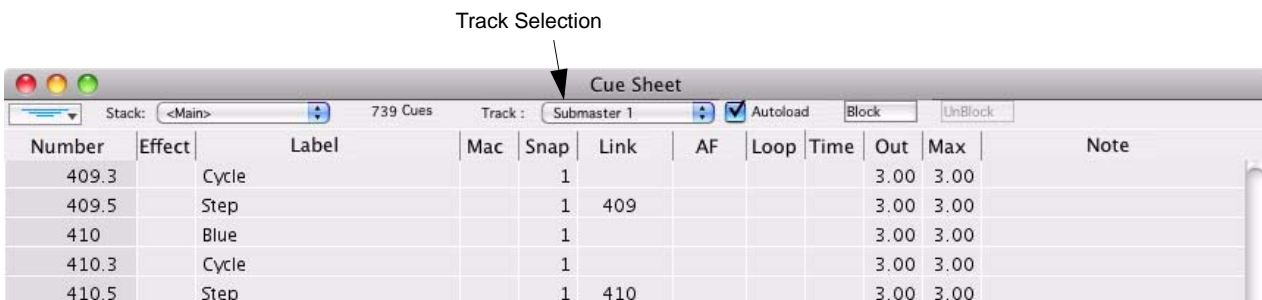

## Submasters Autoload

When the Autoload box is checked in the Cue Sheet window, any selected cue will automatically load and play in the submaster specified in the Track pull-down menu.

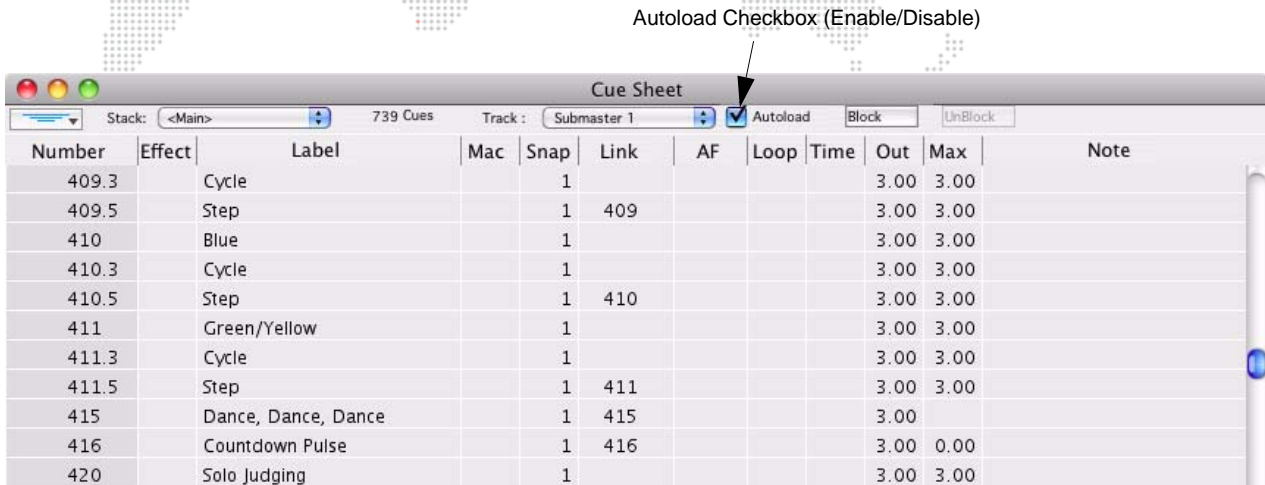

## Submaster Stop/Step

A running cue can be stopped and then stepped through one cue at a time.

- + V476/V676: Press [Stop/Step]
- + V276: Press [Cmd] / [Go]

## Snapshot Indicator

Cues eligible for a cue snap shot will be noted with "-".

## Cue Data

Cue parameter data can be viewed and edited in the Cue Data window. This window displays each stored cue, channel, or parameter. The Cue Data window contains a customizable display and toolbar.

**Note:** Cue data can only be edited if Patch editing is disabled.

### View/Edit Cue Data:

- Step 1. At **Data** menu, select **Cue Data**. Cue Data window will open.
- Step 2. Once window is open, **Enable Cue Editing** menu option will be available (as long as patch editing is disabled). If you wish to edit data, select this option. (Menu will now read "**Disable Cue Editing**.") The [Edit] button is also available to enable/disable editing.
- Step 3. Edit data according to guidelines in "**Cue Editing**" on page 270.
- Step 4. Click **Save Cue** to save changes or click **Revert** to abort.
- Step 5. To protect window from editing, select **Disable Cue Editing**.

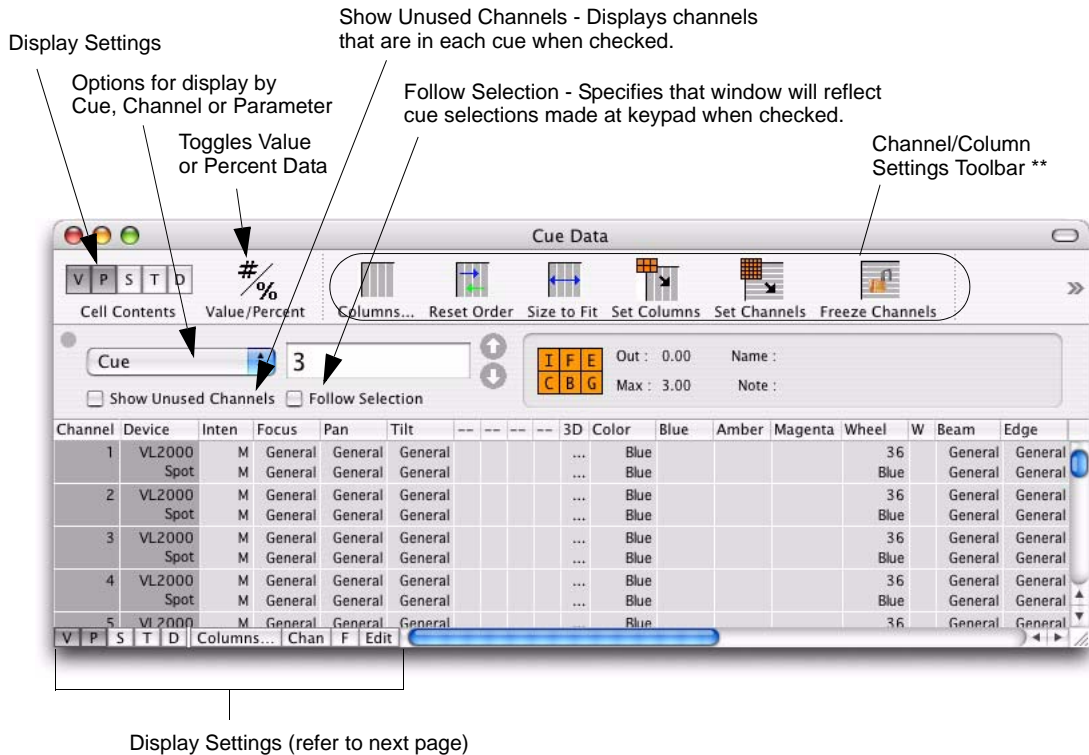
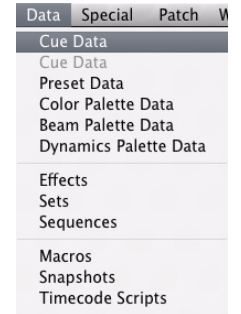
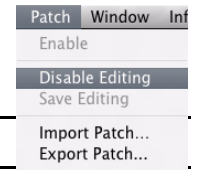

The parameter columns which are displayed can be changed via the Parameter Columns window. Refer to "**Parameter Columns Window**" on page 82.

## Display Settings

Use the following buttons to display different types of data:

- + **Value (V)** - displays the numeric value currently being received by the luminaire for each parameter.
- + **Preset (P)** - displays the Preset being received by the luminaire.
- + **Label (L)** - displays the value label for the cell.
- + **Timing (T)** - displays any associated timing information.
- + **Dynamic (D)** - displays any associated dynamic state information and continuous action such as wheel spins.
- + **Column Window (Columns...)** - opens parameter column window that determines which parameters are displayed.
- + **Set Channels (Chan)** - sets channels from the current channel selection, as limited by the display filter (toggle action). (Refer to "Display Filters" on page 311.)
- + **Freeze Channels (F)** - channels are set to the currently visible channels, and are not affected by subsequent changes to the global display filter (toggle action).
- + **Edit (Edit)** - enables/disables editing. Cells appear red when editing is enabled.

## Keyboard Shortcuts and Tips

- + WIN + R = Reset Order
- + WIN + SHIFT + R = Size To Fit
- + Holding down ALT on the Mac keyboard or [Option] on the front panel and clicking a column will lock the column in place. (Note that locked columns will be moved to the left of the unlocked columns.)
- + Click on a column's header and drag to reposition the column.
- + Hold the cursor over the toolbar icons to view "What's This?" text.

## Customizing Cue Data Window

The Cue Data window can be customized using:

- + Column resizing, including Auto-Size-To-Fit. (Click on the column divider to resize.)
- + Column repositioning. (Click on column header and drag to new position.)
- + Font resizing.
- + Value/Percent display option.
- + Color coding.
- + Set columns with current function filter.
- + Set channels from the current channel selection. (The displayed channels will still also be limited by the display filter.)
- + Freeze channels. (When frozen, the table's channels are set to the currently visible channels, and are not affected by subsequent changes to the global display filter.)

### To customize window:

- + At **View** menu, select parameter to update window configuration.

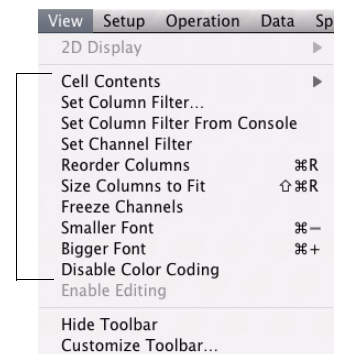

## Customizing Cue Data Toolbar

The Cue Data window toolbar can be customized using the Customize Toolbar window.

### To customize toolbar:

- + At View menu, select **Customize Toolbar...**
- + Drag icons or default set into toolbar.

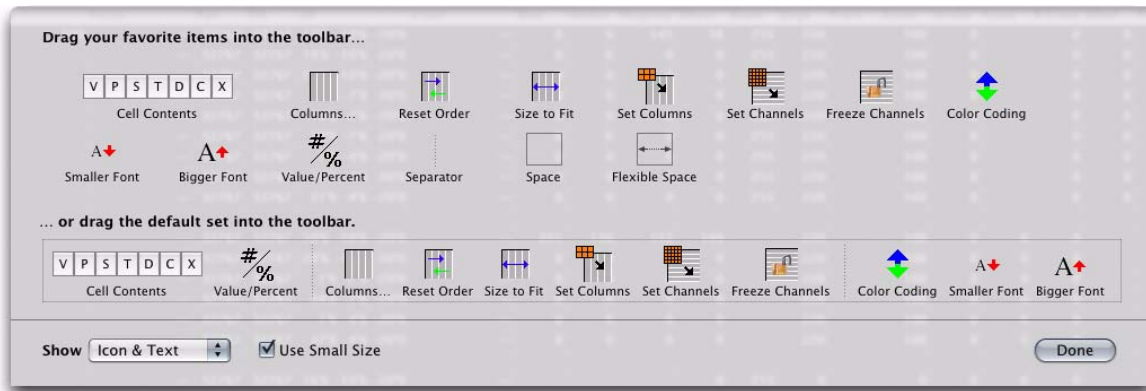
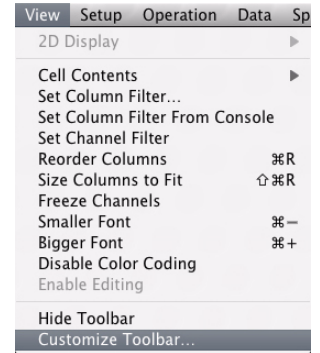

## Cue Editing

Cue data can be edited in the Cue Data window when editing is Enabled.

- + To enable editing, click **Enable Editing** button.

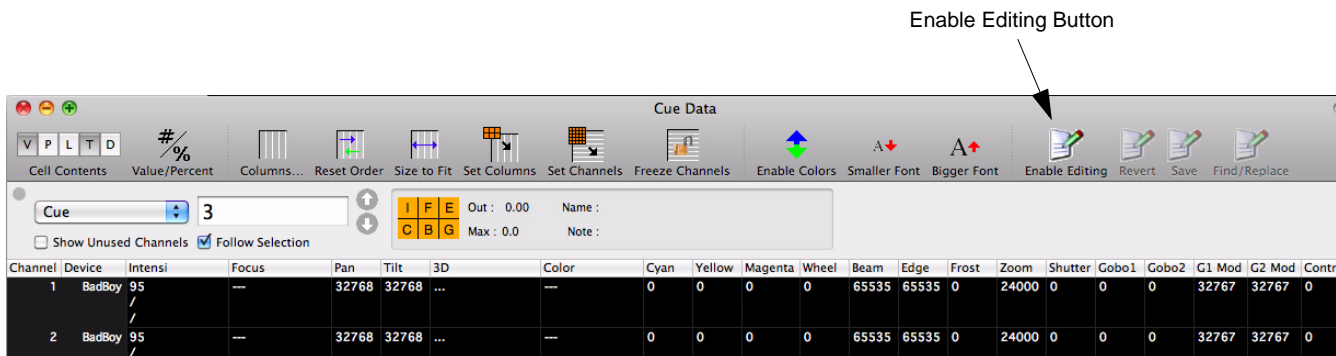

Spreadsheet fields will turn red to indicate that editing is enabled:



Remember to click **Save Cue** to save changes (or click **Revert** to abort changes and reload last saved version of cue).



### Editing specific lines:

- + When editing a specific line of a cell, standard Mac computer text copy and paste rules will apply.

### Selection:

- + To select a cell, click on it.
- + To extend or shrink the current cell selection(s) in a rectangular fashion, hold down the Mac keyboard SHIFT key and click on another cell.
- + To add or remove a specific cell, hold down the Mac keyboard WIN key and click on that cell.

### Copying:

- + Any selection may be copied to the clipboard. All lines of every selected cell are placed on the clipboard. (Value, Parameter Source, Timing, Dynamic). This includes lines that you may have hidden by using the Parameter Columns window.

### Pasting (General):

- + When data is pasted into a cell, all contents of the destination cell are completely replaced with the contents of the cell on the clipboard. The exception would be if data for a line is out of range, in which case it is ignored. However, only those particular lines that are out of range are ignored. The rest of the cell pastes normally.
- + Any parameter may be pasted over any other parameter. Range checking will be performed to prevent data corruption.
- + In general, it is not possible to edit, copy, or paste any parameter column that is not in the table. The exception is the Focus and Color columns. Pasting into one of these columns is equivalent to pasting the same cell into ALL of its component columns. This will occur whether or not the component columns have been selected in the Parameter Columns window.

### Pasting (One-To-Many)

- + If only one cell is resident on the clipboard, the contents of that one cell will be pasted into all selected cells.

### Pasting (Many-To-Many)

- + If more than one cell is resident on the clipboard, the following method is used.:

Data is pasted in Row by Row. There is a 1:1 mapping of rows in the clipboard to rows in the selection. If there are more rows in the selection than there are in the clipboard, nothing will be pasted into these rows. If there are fewer rows in the selection than on the clipboard, the remaining rows in the clipboard will be ignored.

---

**Note:** This same logic is applied to extra cells in the clipboard or selection for each row.

---

### Cue Data Find/Replace

The Find/Replace function can also be used for spreadsheet editing.

---

**CAUTION:** Be sure no edits have been made in the window prior to starting this process.

---

---

**Note:** The cue in which edits are being made must be selected on the front panel cue sheet and channels that are being changed must be selected after edits.

---

**To use Find/Replace function:**

Step 1. At Cue Data window, click **Enable Editing** button while in Cue view. (Spreadsheet fields will turn red to indicate that editing is enabled.)

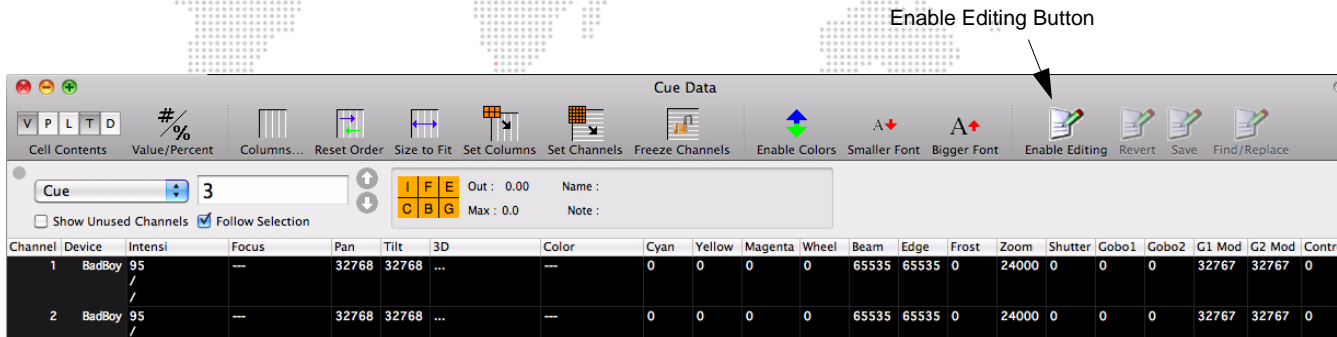

Step 2. Make edits in ONE ROW that is to be the "template row" for the replace. (The fact that a cell in this row has been changed flags its columns as those that will be used for the replace.)

Step 3. In Template Row, select cells (columns) to be used as the search pattern (this is based on the pre-edit values of these cells).

Step 4. Click **Find/Replace** button.

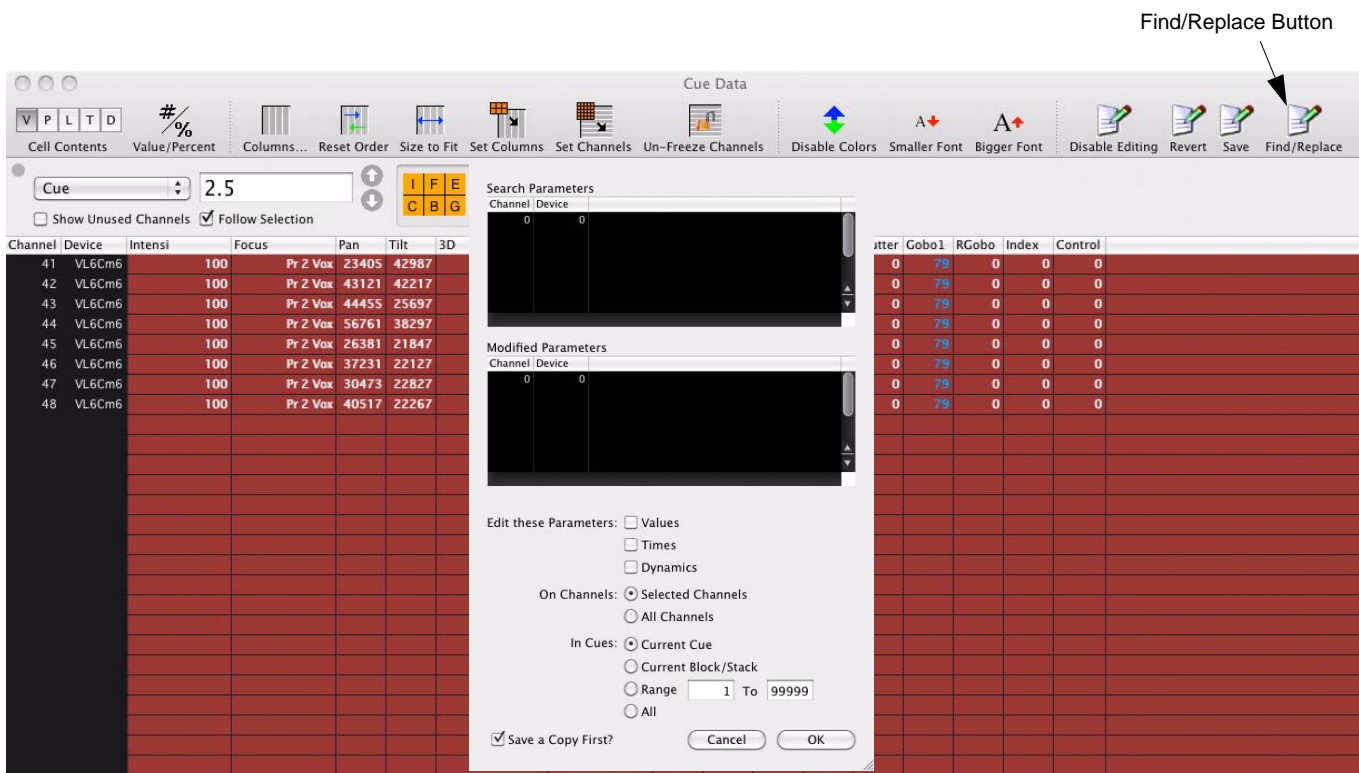

Step 5. At Find/Replace window, select options for the data to change and the channels and cues to search in, as well as, whether or not to save a copy of the show file first before the replace.

Step 6. Click **OK**. Replacements will be made in the spreadsheet. (It may take a few seconds for everything to change if the show file is large.)



# CUE STACKS

## Overview

Cue Stacks (also known as "multiple cue lists") allow for additional cue lists separate from the main cue list. Each cue stack can have its own set of cue numbers and includes the ability to store submaster attributes such as bump modes, creation of cue based chases, etc. Cue Stacks can be stored using the command-line keypad, Stack palette and/or a submaster. They can be labelled, contain attributes and can be played back like a normal cue. (The console allow for up to 1000 Cue Stacks.)

Cue numbers are displayed in an X-Y format, where X is the stack number and Y is the cue number. (The Main Cue List is the default Cue Stack unless otherwise specified.) The following are examples of the new numbering system:

- + **1-52** = Cue Stack 1, Cue 52.
- + **2-1** = Cue Stack 2, Cue 1.
- + **5-14** = Cue Stack 5, Cue 14.

Everything that can be done with standard cues can be done with stacks, such as selective storing and tracking.

## Stacks in the Command Line

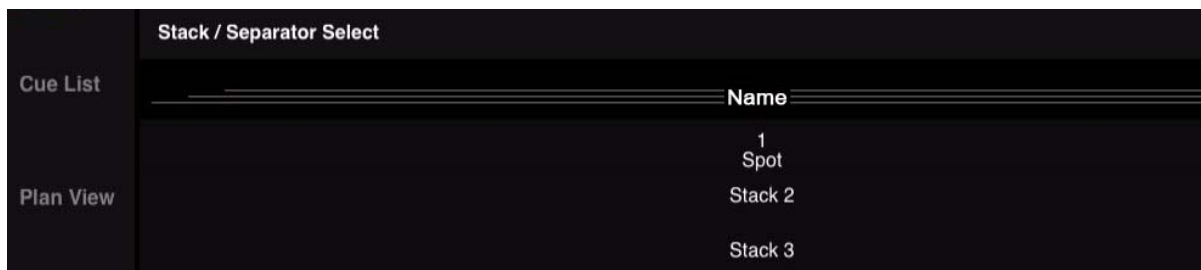

Cue Stacks can be stored in the command line much the same as standard cues, with the addition of the Cue Stack prefix. For example, [Store] [2] [-] [1] [Enter] will store Cue 1 into Stack 2. If Stack 2 did not exist, it would be created by this command.

### Examples:

- + [Store] [Cue] [x] [-] [y] [Enter] - adds Cue y to Stack x.
- + [Store] [Cue/Cue] [x] [Enter] - stores a new Stack x.  
(Double-clicking the [Cue] button in the command line will bring up the Stack prompt. [Cue/Cue] represents a double-click action.)
- + [Selective Store] [Cue Stack] [n] [Enter] *or* [Selective Store] / [Cue Stack Palette] - "selective stores" to all cues in the stack.
- + Pressing and holding [Selective Store] while choosing a submaster - "selective stores" to an individual cue. (Refer to "**Submaster Choose**" on page 280.)
- + [Delete] [Cue/Cue] [y] [Enter] - deletes Stack y.
- + [Cue/Cue] [4] [Enter] - stages Stack 4.
- + [Sub] [4] [Cue/Cue] - loads Stack 4 into Submaster 4.
- + [Store] [Cue/Cue] [5] - stores a new cue at the end of Stack 5.

\* Double-clicking the [Cue] button in the command line will bring up the Stack prompt. [Cue/Cue] represents a double-click action.

## Stacks Palette

Stacks are stored in the Stack palette banks and can be accessed on any of the palettes just as Presets, Colors, Beams, Groups, Macros, and Effects or from the keypad. For instructions on using the palettes, refer to the "Palettes" chapter on page 103.

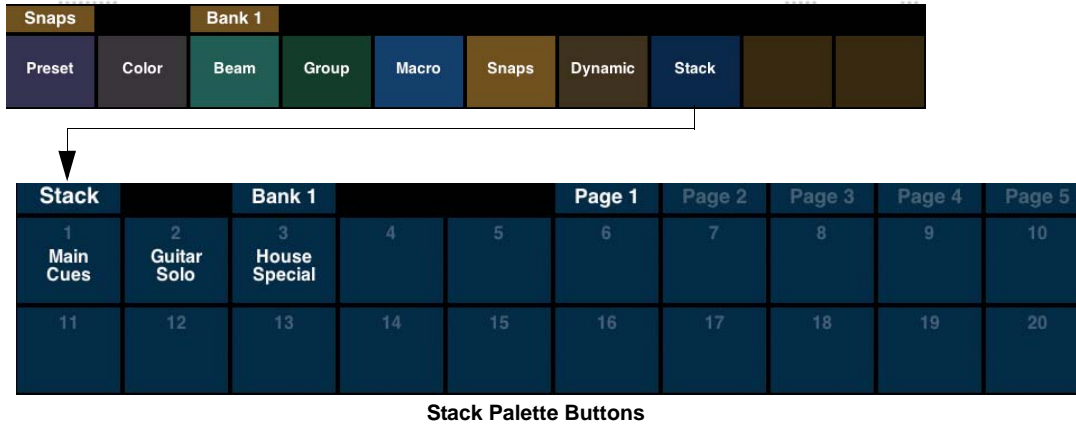

Stack Palette Buttons

A Stack can be stored directly into a palette by holding the [Store] button down while selecting the desired palette. If the stack is empty, it will create the first cue. If the stack already has cues, it will create a new cue at the end of the stack.

## Stacks in the Cue Sheet Window

The Cue Sheet window displays the current Cue Stack, along with new Cue Stack toolbar functions. A pop-up menu allows selection of Cue Stacks by number.

To open the Cue Sheet window, select **Cue Sheet** from the **Operation** menu.

### Guidelines:

- + To create, view and edit Cue Stacks, open the Cue Sheet window by selecting **Cue Sheet** from the **Operation** menu.
- + The Cue Stack toolbar will only be visible when a Cue Stack is selected.
- + The "Stack" pop-up menu will display the currently selected Cue Stack when the window is first opened.
- + Use the "Stack" pop-up menu to select and display any stored Cue Stack. (Only *previously stored* Cue Stacks will be available).
- + Cue Stack attributes are stored per each Cue Stack.

Operation	Data	Special
<b>Cue Sheet</b>		
Board Cue Sheet		
Plan View		⌘B
3D Graphic		⌘G
Luminaire Status		⌘S
Tracking Changes		⌘5
Intensity		⌘I
Timecode		
<b>Palettes</b>		
Channel Select		
Century Palette		
Timing/Filter Display		
276 Display		
<b>Command HUD</b>		
Submaster HUD		

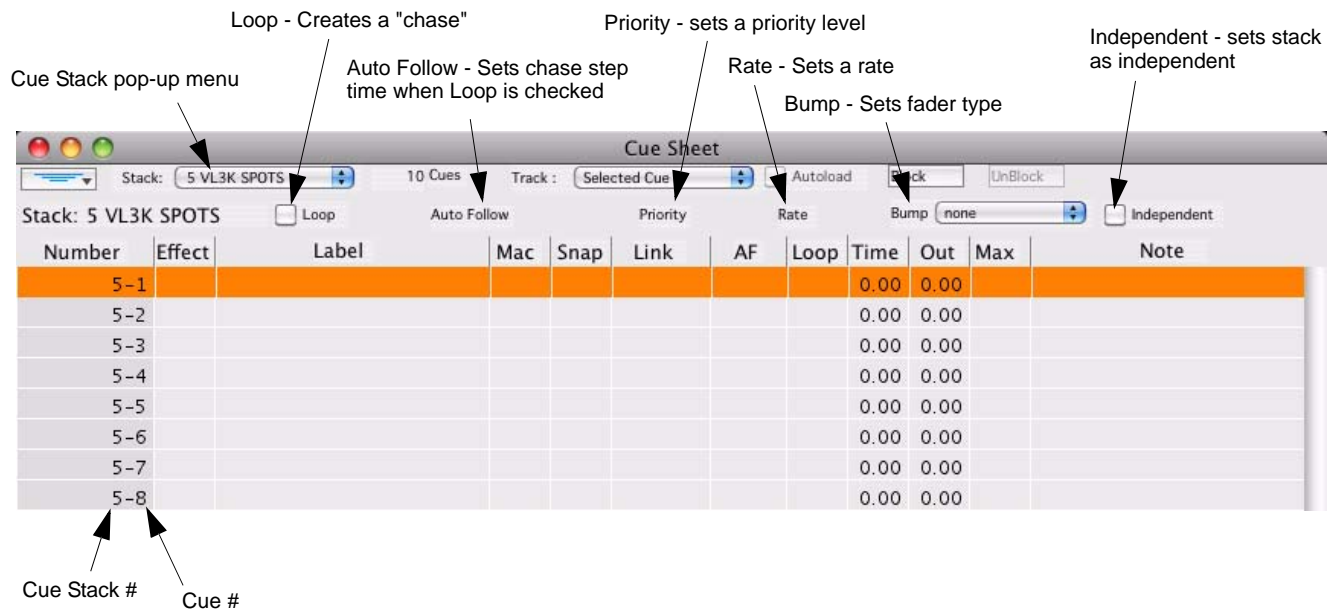

## Using Stacks with Submasters

Cue Stacks can be used with the submasters just as standard cues. These are a few examples of stack/submaster operations:

- + Pressing and holding [Store] while choosing an empty submaster will create a cue in the next available empty stack. (Refer to "Submaster Choose" on page 280.)
- + Pressing and holding [Store] while choosing a submaster with a stack will create a new cue at the end of the stack. (Note that Store-Choose on a submaster cue in the main cue list will store the active cue instead of creating a new cue. This is to maintain pre-existing behavior for the main cue list.)

Press and Hold [Store] button while "choosing" a submaster

Press the area below a submaster's number to "choose" the submaster

The screenshot shows a control panel with the following elements:

- Buttons:** Store, Update, Grab, Sel Store, Block/UnBk, Park/Unpark.
- Submaster Setup:** Submaster 1, Pri 0, Bump, Timing Disable, Freeze (checked), Manual Assign, Default, IFCB Mode (checked), Brd Ctrl Disable (checked), Inhibitive, Channel Filter, Clear, Rate (checked), Dyn Disable (checked), Independent, Function Filter, Close.
- Cue Stacks:** A grid of 10 submasters (1-10). Each submaster has a stack of cues. Submaster 1 has a stack with 'IFE C B G' and 'rate 100'. Submasters 2-10 also have 'IFE C B G' and 'rate 100' cues.



**12.**

## **SUBMASTERS**

This chapter contains instructions for operating the playback masters.

- + **SUBMASTER OVERVIEW**
- + **SUBMASTER MODES**
- + **PLAYBACK INTENSITY LEVEL**
- + **PLAYBACK**

# SUBMASTER OVERVIEW

## Submaster Controls

The console contains 30 submasters for use in playing back events. These are used for execution of cues (effect or crossfade types) or effects. Submasters can be mapped ten at a time by selecting one of three banks: 1-10, 11-20, or 21-30 as required. Each submaster provides status information which includes pending and active cues/effects, priority level, function filter settings, rate value, submaster modes, timing counter, and step indicator.

Submaster controls can be accessed at the Submaster display available on the front panel (V476/V676 only).

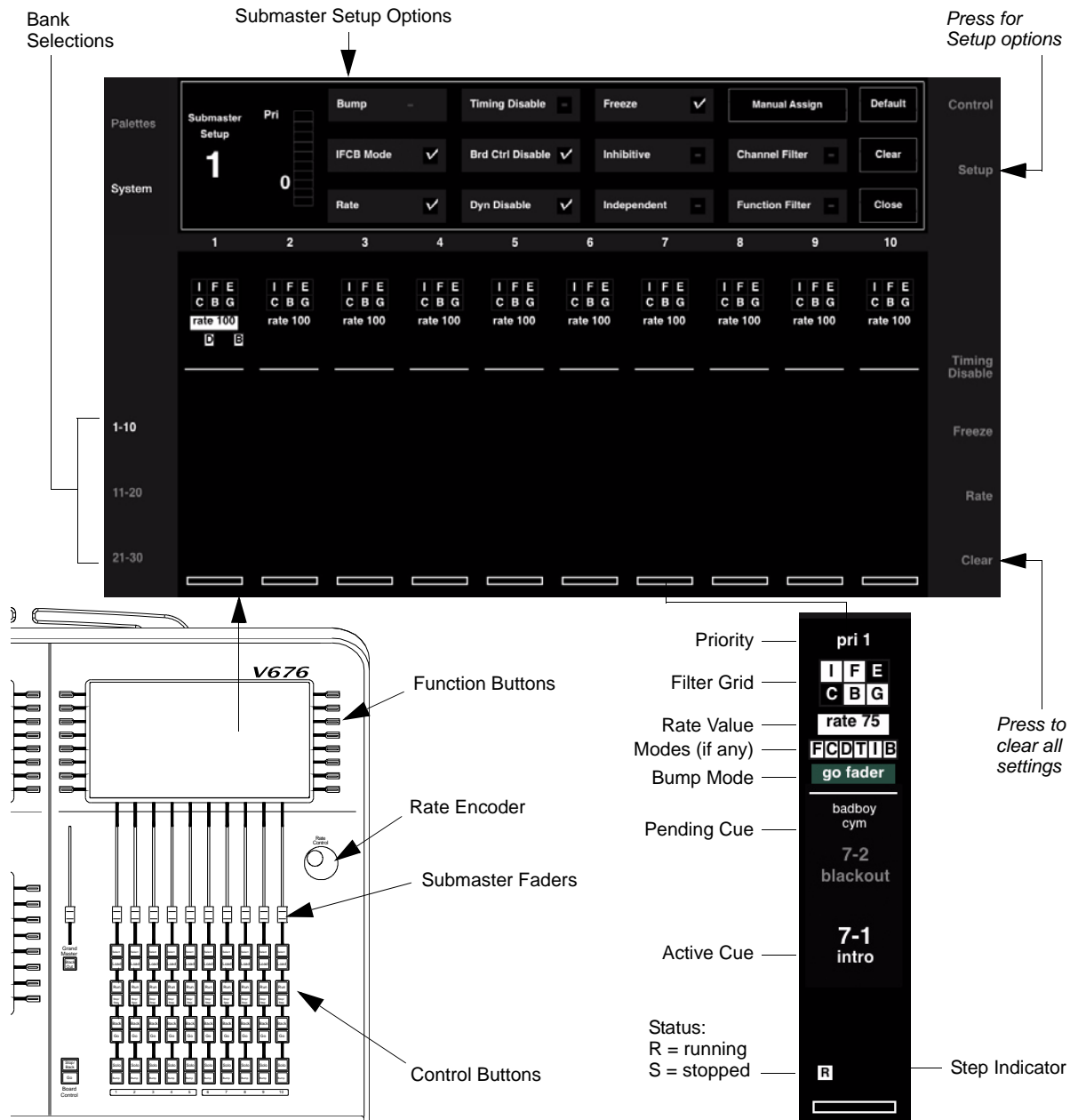

Figure 12-1: Front Panel Submaster Controls (V476/V676 Only)

Submaster controls can also be accessed in the Submaster HUD window (available from the **Operation** menu).

The image shows two views of the Submaster HUD interface. The top view displays a grid of buttons for submasters 1-10, with a 'Bank Selection Menu' overlay showing options for 'Submasters 1-10', 'Submasters 11-20', and 'Submasters 21-30'. The bottom view shows fader displays for submasters 1-10, with a 'Virtual Fader' control on the left. Labels with red arrows point to 'Button Display' and 'Virtual Encoder' in the top view, and 'Fader Display' and 'Virtual Fader' in the bottom view.

Current Submasters Bank

Bank Selection Menu

Button Display

Virtual Encoder

Fader Display

Virtual Fader

Operation	Data	Special
Cue Sheet		
Board Cue Sheet		
Plan View		⌘B
3D Graphic		⌘G
Luminaire Status		⌘S
Tracking Changes		⌘5
Intensity		⌘I
Timecode		
Palettes		
Channel Select		
Century Palette		
Timing/Filter Display		
276 Display		
Command HUD		
Submaster HUD		
Encoder HUD		
Pan/Tilt Control		⌘;
X/Y Control		⌘'

Figure 12-2: Submaster HUD Controls

For more information about the Submaster HUD, refer to "[Submasters HUD Operation](#)" on page 368.

# SUBMASTER MODES

## Overview

### Submaster Modes

A selection of modes may be applied to each submaster using the Setup and Control screens. These modes: Rate, Freeze, Function Filter, Channel Filter, Dynamic Disable, Time Disable, Independent, Bump, and Manual Assign can be used for advanced control of events during playback or to assign control of specific channels to a submaster.

When the Function Filter (F), Channel Filter (C), Dynamic Disable (D), Timing Disable (T), Independent (I), and Board Control Disable (B) modes are assigned, a mode indicator will be displayed accordingly. When a Bump mode type is selected (Add/Solo, Go Fader or Intensity Bump), it will also be displayed.

It is possible to set up all submaster modes without having the submaster selected except Manual Assign.

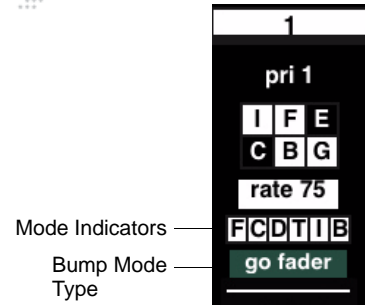

### Submaster Choose

The submaster "choose" function provides a method for selecting (i.e., "choosing") the submaster for the purpose of specifying the submaster when used with various front panel key combinations. "Choose" is activated by touching the specific submaster on the touchscreen while the other key is depressed. For example, to clear a submaster, hold down the <Clear> key and touch the display area for that submaster on the touch screen.

When the area is touched without another key combination, the Submaster Setup options will be displayed as shown in the screen capture below:

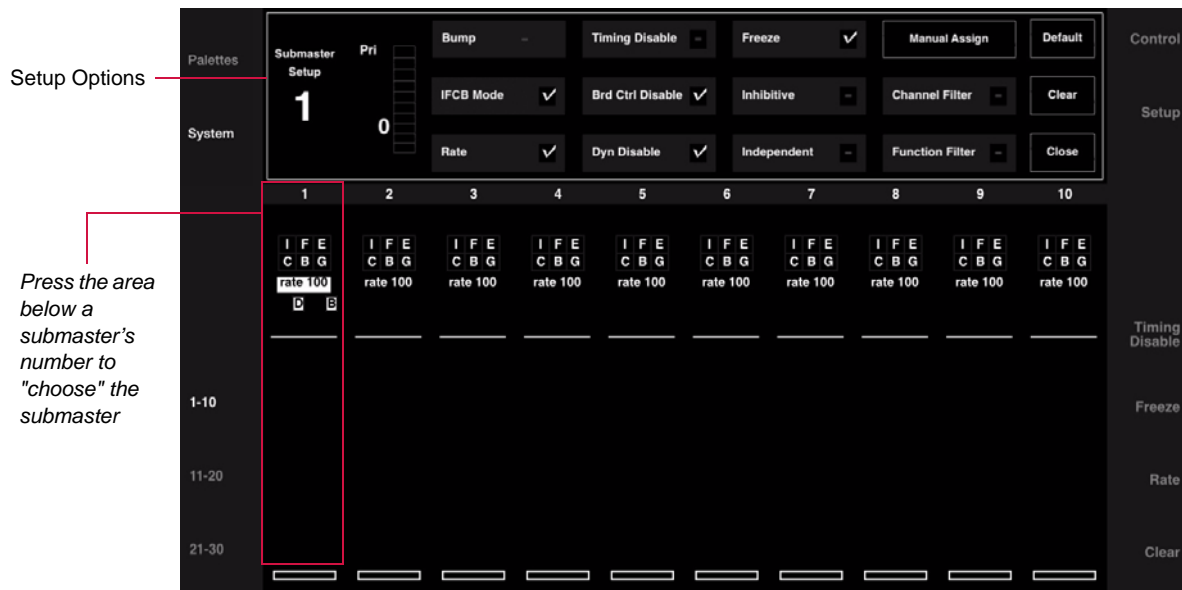



## Control and Setup Screens

Pressing <Control> will display a summary of submaster mode settings for each bank of 10 submasters. Mode setting can be turned off and on at this screen, and defaults may be reset. (Refer to "[Submaster Modes](#)" on page 280 for more information about mode settings.)

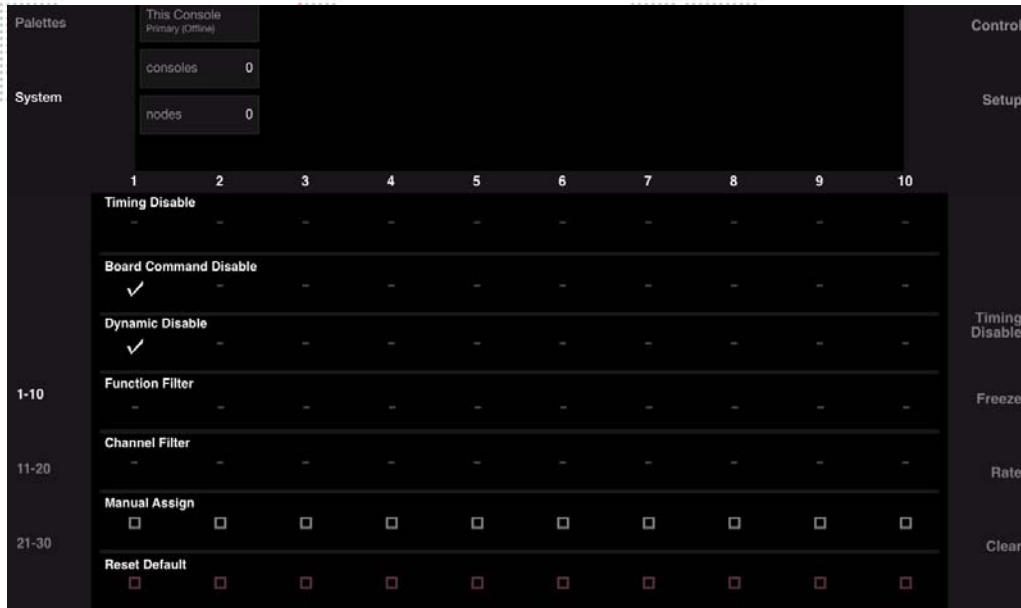

Pressing <Setup> will bring up a summary of additional mode settings for each bank of 10 submasters. Like the Control screen, mode setting can be turned off and on at this screen, and defaults may be reset. (Refer to "[Submaster Modes](#)" on page 280 for more information about mode settings.)

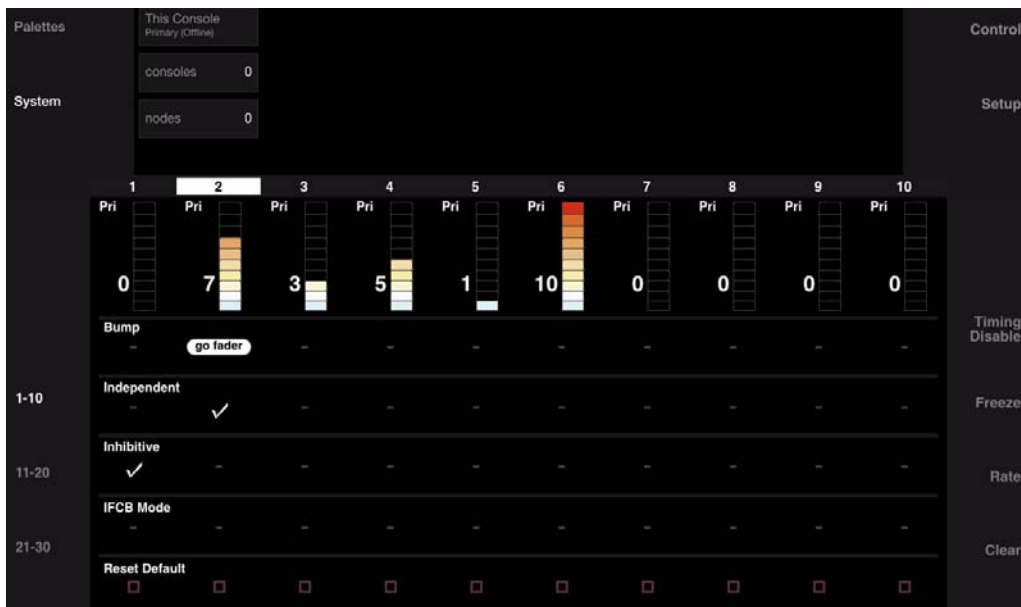

## Clear

The Submaster Setup screen provides options for clearing all modes and for returning to default settings. (Refer to the Mode Control buttons in the screen capture below.)

- + Press **<Default>** to return to the default settings for the selected submaster.
- + Press **<Clear>** to clear all mode settings for the selected submaster.
- + Press **<Close>** to hide the submaster Setup options.

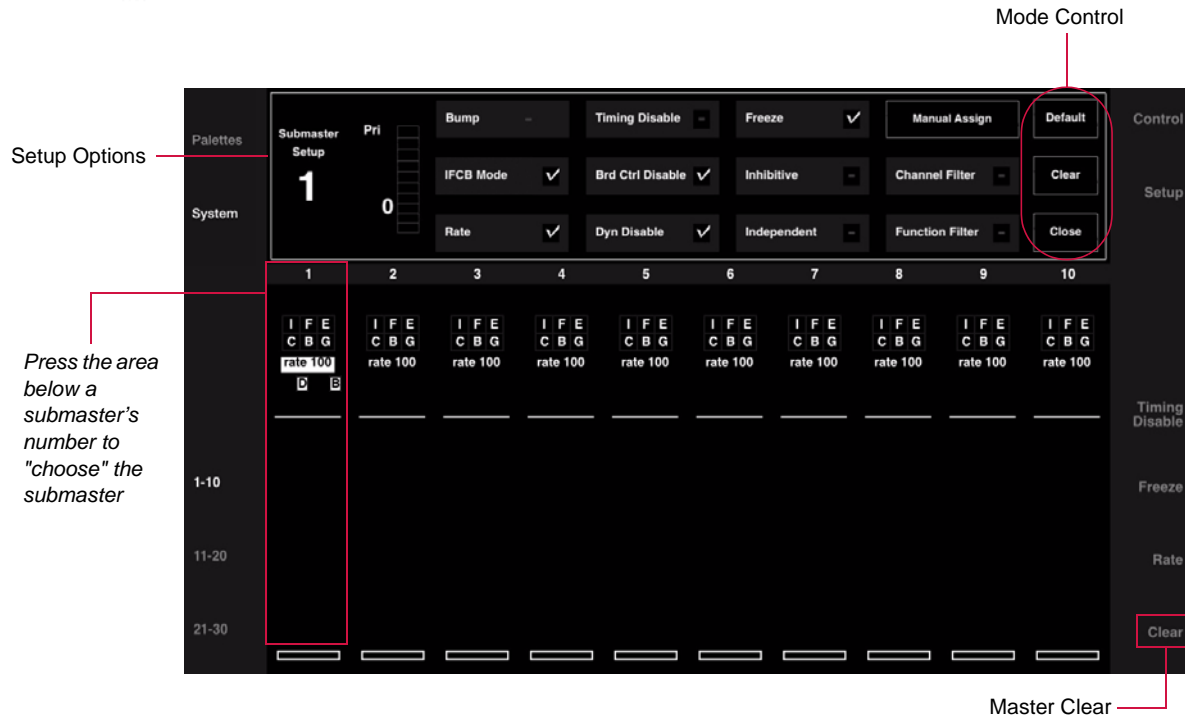

The Master Clear button releases a submaster from any applied modes and clears any active or pending cues (returning the submaster to its default state). This clear feature is a two-step process, so that mode setting and cue information can be cleared separately. (Refer to Master Clear button in the screen capture above.)

### Clear modes, filter, and rate settings from a submaster:

- + Press and hold master **<Clear>** while choosing a submaster. ("Choose" is activated by touching the specific submaster on the touchscreen.)

### Clear active and pending cues from a submaster:

- + Press and hold master **<Clear>** while double-clicking on a submaster.

## Priority

The Priority feature sets a Priority Level from 0-10.

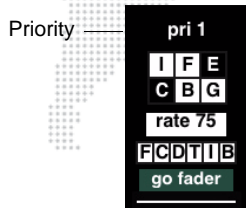

Pile-On / Pile-Off Behavior:

- + Higher priority state overrides lower, deselect returns to lower priority state.
- + Equal priority recall replaces recall at that priority.
- + Intensity: HTP for submasters at a given priority level.

*Example of Submaster Priority Interaction:*

Submaster 1 is assigned to the default priority of zero with Cue 100 "wash look" selected/recalled on stage. Submaster 2 is assigned to priority of 1 with Cue 101 "audience bally" loaded into the submaster. When Submaster 2 is selected, its contents will override Submaster 1 recalling Cue 101. When Submaster 2 is deselected, the console will automatically restore to Cue 100.

**To set priority using command line:**

- + At console keypad, press [Sub] [n] [Thru] [m] [At] p - where p is priority number 0-10.

**To set priority using submaster touchscreen:**

- Step 1. Choose a submaster to bring up its Setup options. ("Choose" is activated by touching the specific submaster on the touchscreen.)
- Step 2. Using touchscreen, set priority level.
- Step 3. Press <Close> to close Setup screen.

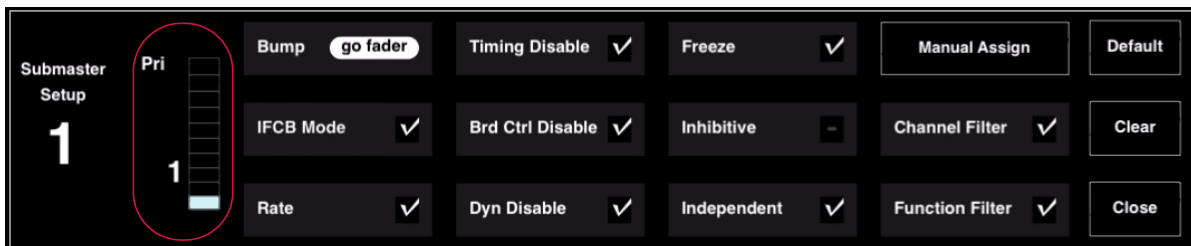

## Bump Modes

There are three types of Submaster Bump modes:

- + **Add/Solo** - provides two types of bump actions. The **Add** function behaves like a momentary Submaster selection. When the [Go] button is pressed, all parameters bump as if the submaster is selected. The **Solo** function behaves like a momentary Submasters selection, plus all other submaster faders go to zero. When the [Back] button is pressed, the submaster's parameters bump and all other submaster's parameters go to zero.
- + **Go Fader** - when in the Go Fader mode, moving a Submaster's fader above zero behaves like a Submaster selection where all parameters bump. This action is identical to the Add/Solo mode, except the action is initiated by the fader instead of by a button press.
- + **Intensity Bump** - instantly "bumps" to the full intensity provided by the cue as modified by the fader position. This mode only affects intensity, resulting in a bump from the current fader position to full.

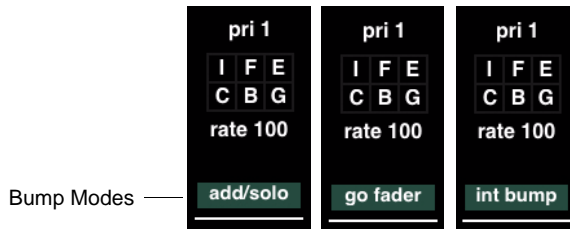

### To set Bump mode using submaster touchscreen:

- Step 1. Choose a submaster to bring up its Setup options. ("Choose" is activated by touching the specific submaster on the touchscreen.)
- Step 2. Press <Bump> to cycle between three Bump modes. Select either Add/Solo, Go Fader or Intensity Bump.
- Step 3. Press <Close> to close Setup screen.

### To release a submaster from Bump mode using submaster touchscreen:

- Step 1. Choose a submaster to bring up its Setup options. ("Choose" is activated by touching the specific submaster on the touchscreen.)
- Step 2. Press <Bump> until it cycles to the blank setting *or* press <Clear> to clear *all* submaster settings.
- Step 3. Press <Close> to close Setup screen.

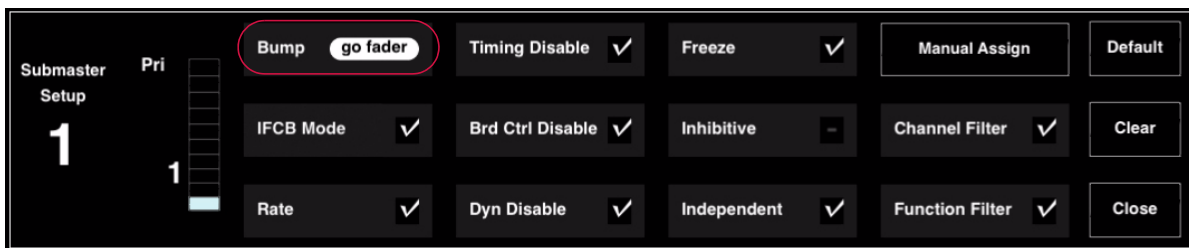

## Intensity Mode

The Intensity Bump mode, instantly "bumps" to the full intensity provided by the cue as modified by the fader position. This mode only affects intensity, resulting in a bump from the current fader position to full.

### Bump intensity of active cue to 100%:

- Step 1. Set submaster to Intensity Bump mode (see previous page). [Go] will begin flashing.
- Step 2. Press [Go] to bump intensity.



## Add/Solo Mode

The Add/Solo mode provides two types of bump action, depending on what button is pressed:

- + **Add** - [Go] button. This function behaves like a momentary Submaster selection. When the [Go] button is pressed, all parameters bump as if the submaster is selected.
- + **Solo** - [Back] button. This function behaves like a momentary Submasters selection, plus all other submaster faders go to zero. When the [Back] button is pressed, the submaster's parameters bump and all other submaster's parameters go to zero.

*Example:*

- Step 1. Set submaster to Add/Solo mode (see previous page). [Select] will begin flashing.
- Step 2. Press [Go] button to execute an add bump or press [Back] to execute a solo bump.

## Go Fader Mode

When in the Go Fader mode, moving a Submaster's fader above zero behaves like a Submaster selection where all parameters bump. This action is identical to the Add/Solo mode, except the action is initiated by the fader instead of by a button press.

*Example:*

- Step 1. Set submaster to Go Fader mode (see previous page). [Select] will begin flashing.
- Step 2. Move fader up to execute bump action.
- Step 3. Move fader down to release.

## IFCB Faders

The IFCB faders use existing submaster priority concepts to allow manual crossfading between an IFCB fader cue and a lower priority state. While in IFCB mode, all controlled parameters (as defined by the normal channel and function filter) in the active cue will interpolate their positions between the current submaster state and the next lower priority state (as defined by normal priority rules).

For example, Sub 1 is running at priority 0, and Sub 2 is set up as an IFCB fader at priority 10 (all parameters, all channels). If Sub 2 is selected with its fader all the way down, there is no change on stage. As the Sub 2 fader is raised, all affected parameters will move towards the goal of the active cue in Sub 2. Once the Sub 2 fader is all the way up, the lower priority data is no longer used.

---

**Note:** Timing is ignored unless the fader is at full or zero, in which case the higher priority or lower priority values are used, respectively.

---

When IFCB mode is active, the function filter grid will be highlighted in blue:

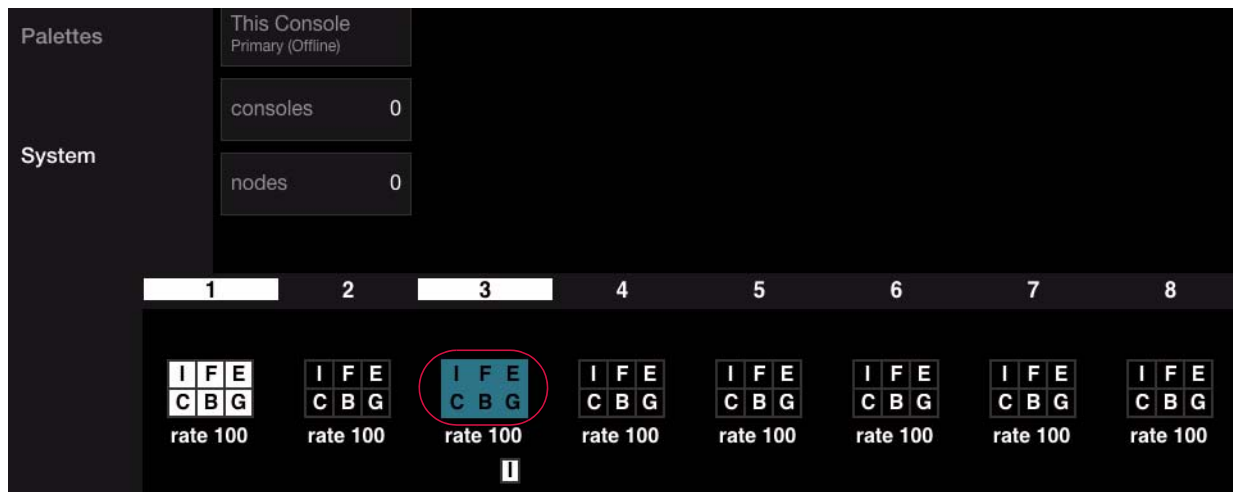

### To set IFCB mode using submaster touchscreen:

- Step 1. Choose a submaster to bring up its Setup options. ("Choose" is activated by touching the specific submaster on the touchscreen.)
- Step 2. Select  (IFCB Mode) checkbox.
- Step 3. Press  to close Setup screen.

### To release a submaster from IFCB mode using submaster touchscreen:

- Step 1. Choose a submaster to bring up its Setup options. ("Choose" is activated by touching the specific submaster on the touchscreen.)
- Step 2. Deselect  (IFCB Mode) checkbox *or* press  to clear *all* submaster settings.
- Step 3. Press  to close Setup screen.

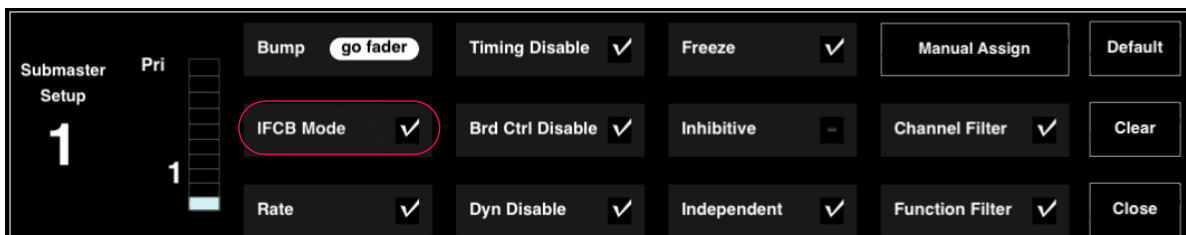

## Rate

The Rate feature speeds up or slows down the playback of events (cues or effects).

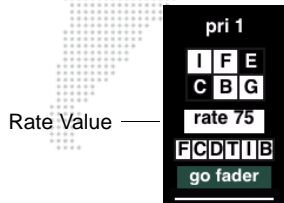

The Rate encoder allows a percentage adjustment from 0-999 with 999% being the fastest rate and 0% causing the event to stop.

- + The default is 100%, which is real time (5 seconds = 5 seconds).
- + Decrease the percentage to slow down the event (50% rate applied to 5 seconds = 10 seconds).
- + Increase the rate percentage to speed up the event (200% rate applied to 5 seconds = 2.5 seconds).

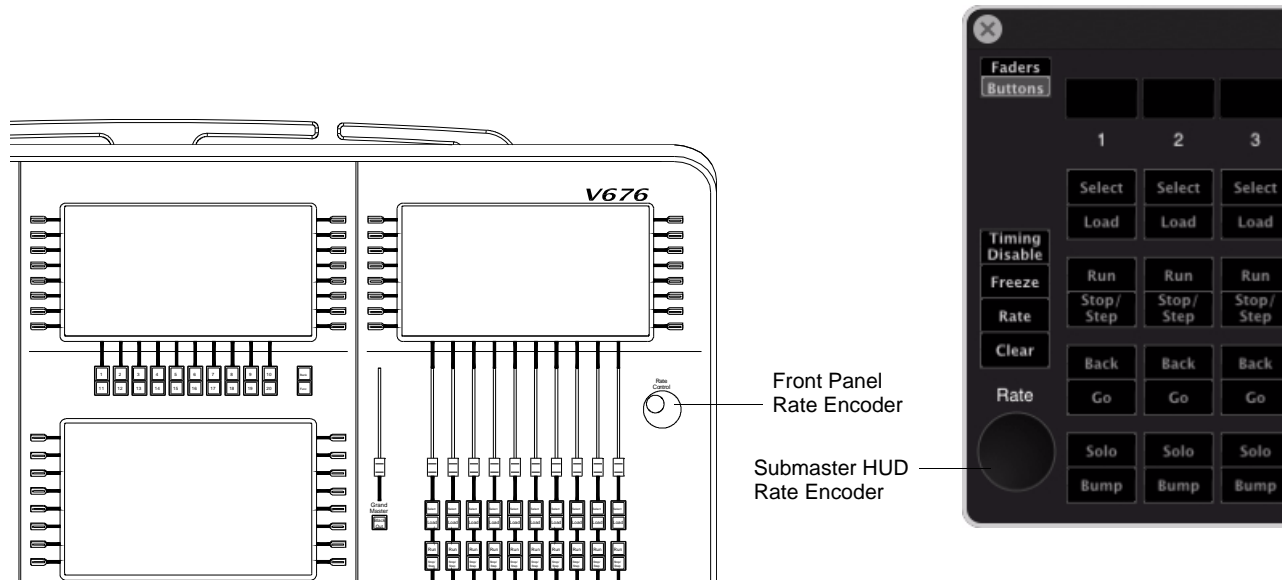

Figure 12-3: Rate Encoder

### Guidelines:

- + All timing values associated with an event (luminaire delay and times, cue out time, waits and trails) are affected by the rate modification proportionally.
- + If a cue is complete, the rate adjustment will affect the pending cue. When the pending cue is activated, the adjusted rate is used to determine timing.

### To set rate mode using submaster touchscreen:

- Step 1. Choose a submaster to bring up its Setup options. ("Choose" is activated by touching the specific submaster on the touchscreen.)
- Step 2. Using touchscreen, select <Rate> checkbox.
- Step 3. Press <Close> to close Setup screen.
- Step 4. Use Rate encoder to adjust rate to required value.

**To clear rate mode using submaster touchscreen:**

- Step 1. Choose a submaster to bring up its Setup options. ("Choose" is activated by touching the specific submaster on the touchscreen.)
- Step 2. Deselect <Rate> checkbox *or* press <Clear> to clear *all* submaster settings.
- Step 3. Press <Close> to close Setup screen.

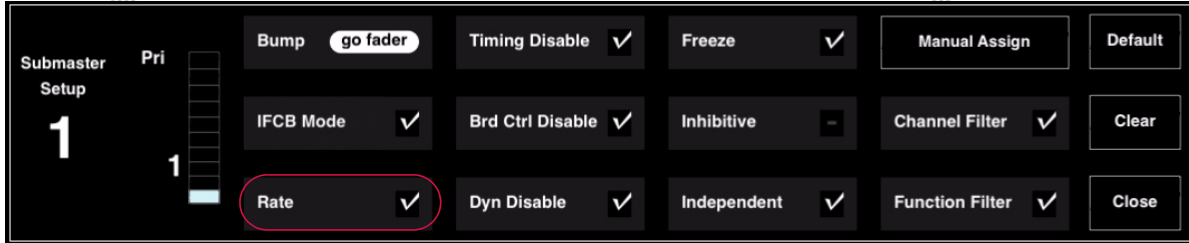

**To select rate control for a submaster using "choose" method:**

- Step 1. Press and hold <Rate> while choosing a submaster. ("Choose" is activated by touching the specific submaster on the touchscreen.)
- Step 2. Use Rate encoder to control rate.

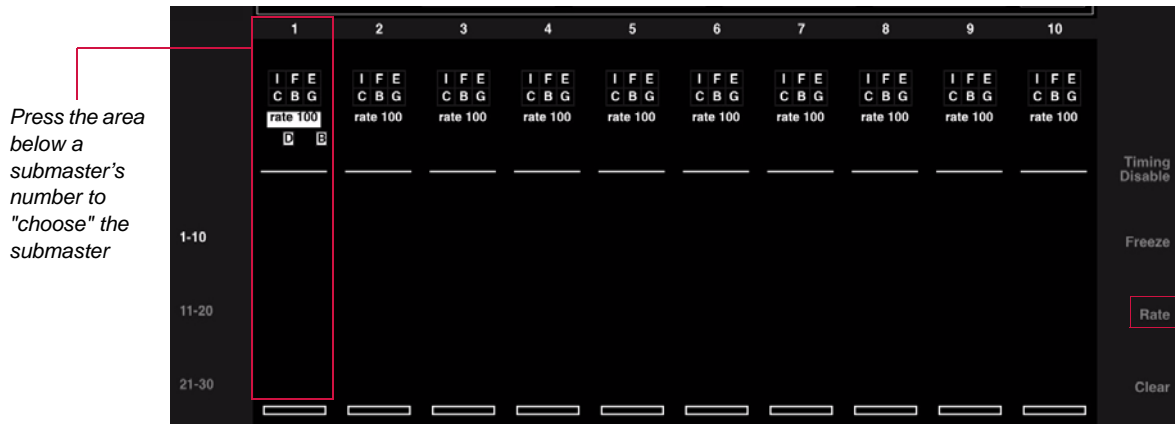



## Timing Disable

The Timing Disable feature causes timing data to be ignored for any cues that are activated on that submaster while it is in timing disable mode.

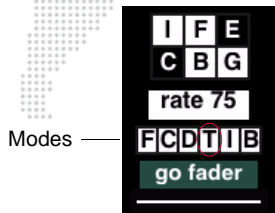

### To set Timing Disable mode using submaster touchscreen:

- Step 1. Choose a submaster to bring up its Setup options. ("Choose" is activated by touching the specific submaster on the touchscreen.)
- Step 2. Select <Timing Disable> checkbox.
- Step 3. Press <Close> to close Setup screen.

### To release a submaster from Timing Disable mode using submaster touchscreen:

- Step 1. Choose a submaster to bring up its Setup options. ("Choose" is activated by touching the specific submaster on the touchscreen.)
- Step 2. Deselect <Timing Disable> checkbox *or* press <Clear> to clear *all* submaster settings.
- Step 3. Press <Close> to close Setup screen.

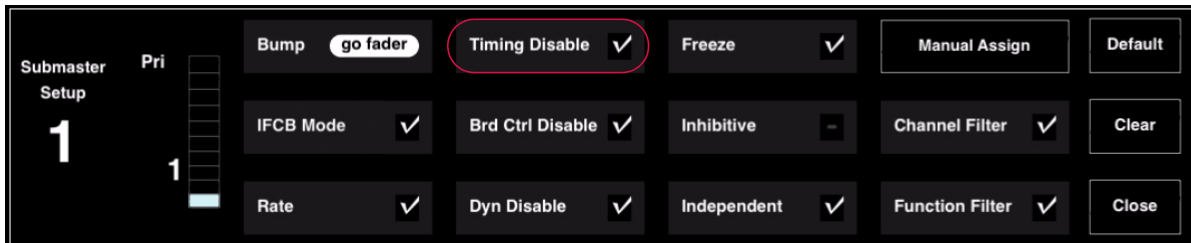

### To select Timing Disable mode for a submaster using "choose" method:

- + Press and hold <Timing Disable> while choosing a submaster. ("Choose" is activated by touching the specific submaster on the touchscreen.)

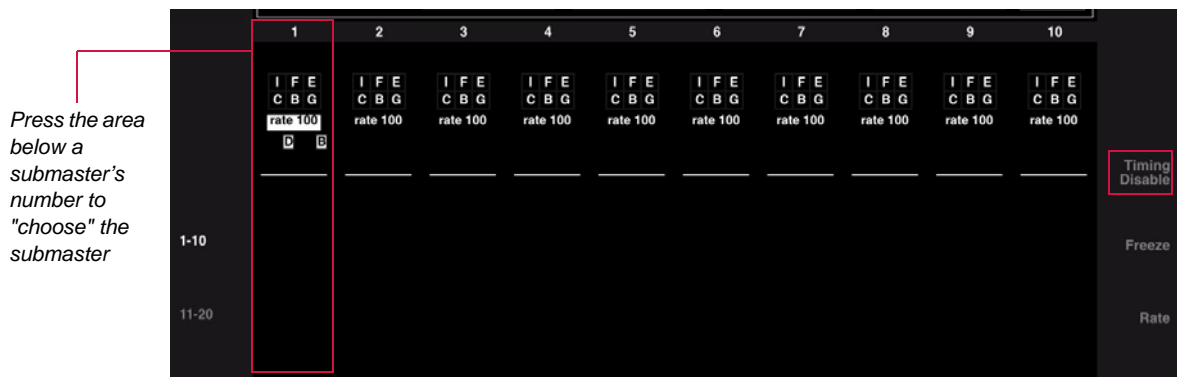

## Board Control Disable

The Board Control Disable feature causes any linked snapshots, macros or autofollows to be ignored during playback of any cue. This feature can be useful for recalling the core data for any cue.

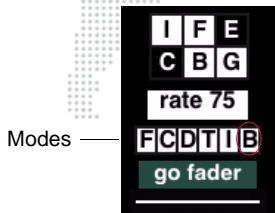

### To set Board Control Disable mode using submaster touchscreen:

- Step 1. Choose a submaster to bring up its Setup options. ("Choose" is activated by touching the specific submaster on the touchscreen.)
- Step 2. Select  (Board Control Disable) checkbox.
- Step 3. Press  (Close) to close Setup screen.

### To release a submaster from Board Control Disable mode using submaster touchscreen:

- Step 1. Choose a submaster to bring up its Setup options. ("Choose" is activated by touching the specific submaster on the touchscreen.)
- Step 2. Deselect  (Board Control Disable) checkbox *or* press  (Clear) to clear *all* submaster settings.
- Step 3. Press  (Close) to close Setup screen.

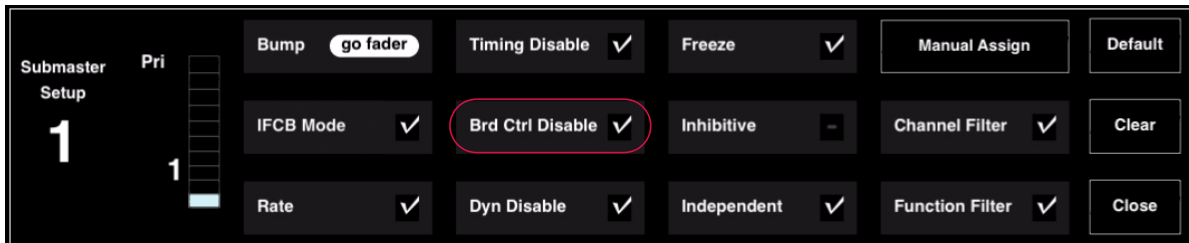

## Dynamic Disable

The Dynamic Disable feature disables the playback of any macros and/or snapshots linked to a cue. For example, if you wish to view data in a particular cue, you could disable any linked event(s) so that it will not occur upon completion of the cue.

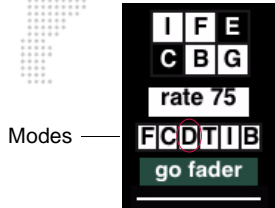

### To set Dynamic Disable mode using submaster touchscreen:

- Step 1. Choose a submaster to bring up its Setup options. ("Choose" is activated by touching the specific submaster on the touchscreen.)
- Step 2. Select <Dynamic Disable> checkbox.
- Step 3. Press <Close> to close Setup screen.

### To release a submaster from Dynamic Disable mode using submaster touchscreen:

- Step 1. Choose a submaster to bring up its Setup options. ("Choose" is activated by touching the specific submaster on the touchscreen.)
- Step 2. Deselect <Dynamic Disable> checkbox *or* press <Clear> to clear *all* submaster settings.
- Step 3. Press <Close> to close Setup screen.

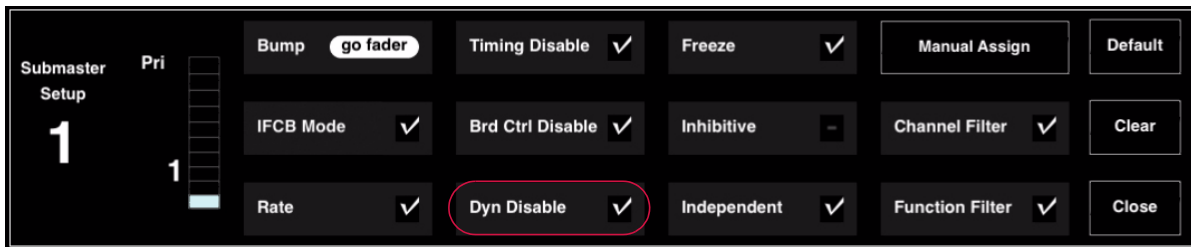

## Freeze

The Freeze feature halts an event in mid-transition.

**Note:** If a cue is stored while a submaster is frozen, the end goal of the event will be the data stored.

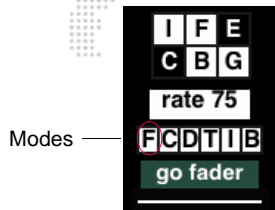

While in Freeze mode, an indication will be shown in the submaster's display:

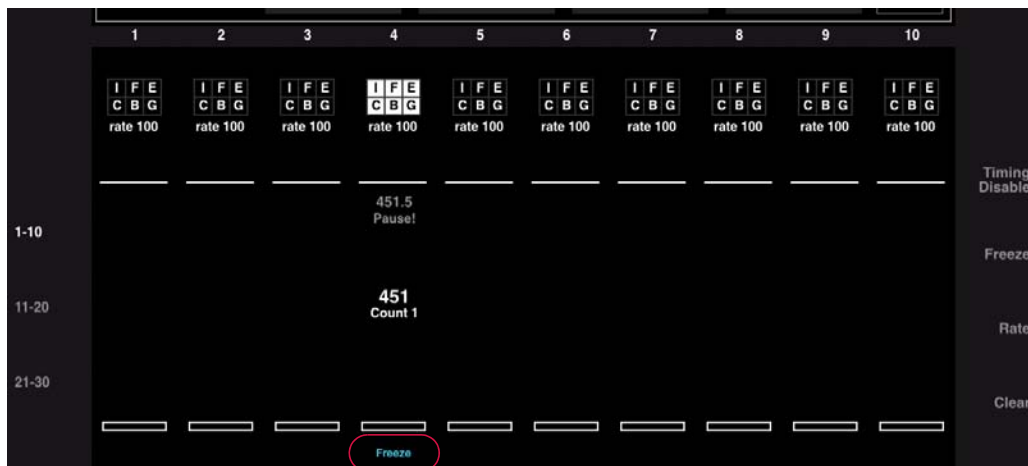

### Freeze a cue using submaster touchscreen:

- Step 1. Choose a submaster to bring up its Setup options. ("Choose" is activated by touching the specific submaster on the touchscreen.)
- Step 2. Select <Freeze> checkbox. This will instantaneously halt the cue or effect.
- Step 3. Press <Close> to close Setup screen.
- Step 4. Press the [Run] button to resume cue, or press [Back] button to fade to previous cue on that submaster in associated time values, (unless timing is filtered).

### To release a submaster from Freeze mode using submaster touchscreen:

- Step 1. Choose a submaster to bring up its Setup options. ("Choose" is activated by touching the specific submaster on the touchscreen.)
- Step 2. Deselect <Freeze> checkbox *or* press <Clear> to clear *all* submaster settings.
- Step 3. Press <Close> to close Setup screen.

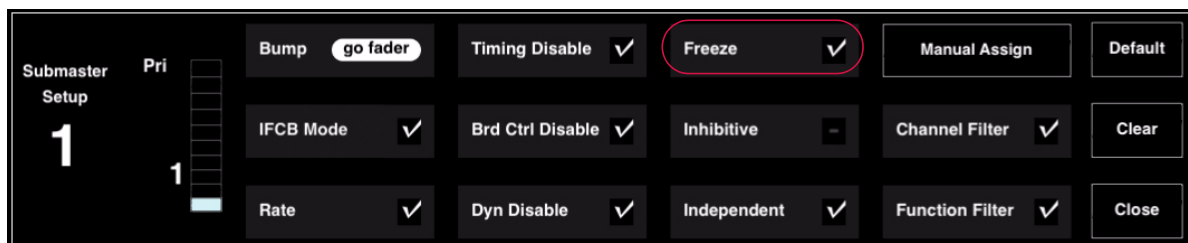

**Store a Freeze state as cue:**

- + Press and hold <Freeze> while choosing a submaster. ("Choose" is activated by touching the specific submaster on the touchscreen.)

Press the area below a submaster's number to "choose" the submaster

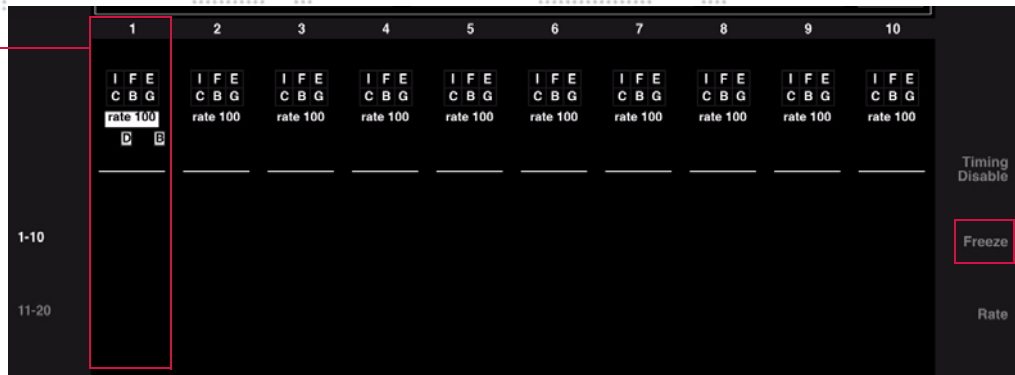

**Inhibitive**

When set to the Inhibitive mode, the submaster will act as a grandmaster fader for all channels associated with that submaster.

**Note:** Use the Channel Filter mode to select which channels will be controlled by the submaster. For instructions on using the Channel Filter, refer to "Channel Filter" on page 297.

**To set Inhibitive mode using submaster touchscreen:**

- Step 1. Choose a submaster to bring up its Setup options. ("Choose" is activated by touching the specific submaster on the touchscreen.)
- Step 2. Select <Inhibitive> checkbox.
- Step 3. Press <Close> to close Setup screen.

**To release a submaster from Inhibitive mode using submaster touchscreen:**

- Step 1. Choose a submaster to bring up its Setup options. ("Choose" is activated by touching the specific submaster on the touchscreen.)
- Step 2. Deselect <Inhibitive> checkbox *or* press <Clear> to clear *all* submaster settings.
- Step 3. Press <Close> to close Setup screen.

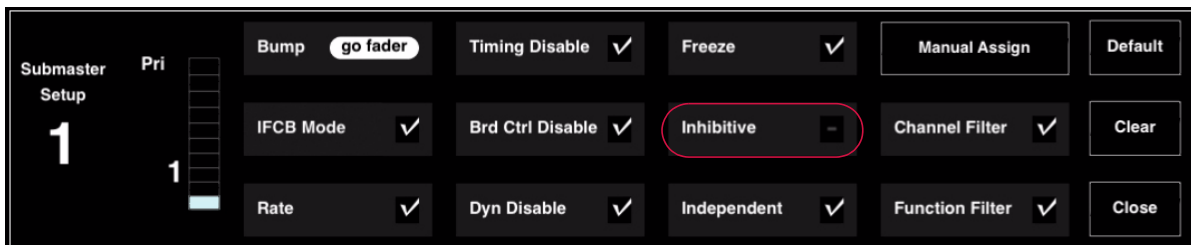

## Independent

The Independent feature prohibits a specific submaster from having its content modified by any other submaster (although it can still be modified manually or by the Grand Master/Blackout fader).

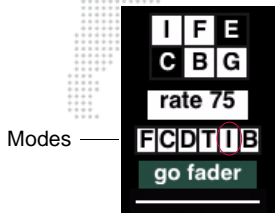

*Example:*

If a channel is controlled by Submaster 1 and intensity control is subsequently assumed by Submaster 2, and Submaster 2 is independent, that intensity value is now independent and cannot be affected by any changes to Submaster 1's fader setting.

### To set Independent mode using submaster touchscreen:

- Step 1. Choose a submaster to bring up its Setup options. ("Choose" is activated by touching the specific submaster on the touchscreen.)
- Step 2. Select  (Independent) checkbox.
- Step 3. Press  (Close) to close Setup screen.

### To release a submaster from Independent mode using submaster touchscreen:

This action will not modify the output of the submaster, only enable those channels/parameters to be available for control by other playbacks.

- Step 1. Choose a submaster to bring up its Setup options. ("Choose" is activated by touching the specific submaster on the touchscreen.)
- Step 2. Deselect  (Independent) checkbox *or* press  (Clear) to clear *all* submaster settings.
- Step 3. Press  (Close) to close Setup screen.

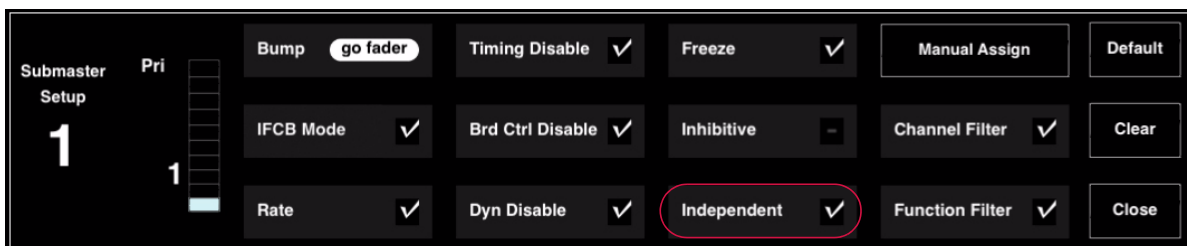

## Manual Assign

The Manual Assign feature loads any selected channels and their current parameter settings into the submaster for control. The submaster fader can then be used to scale the intensity output for those channels. For example, this function could be used to adjust the intensities of specific luminaires in order to brighten or dim certain areas of a stage.

When channels are manually assigned to a submaster, the current cue or stage look associated with those channels is now controlled by the submaster fader until such time as the manual assignments are cleared from the submaster, a new cue is played, or a manual control action is made at the Manual Control panel.

### Guidelines:

- + Channels/parameters can be taken away from the submaster when a new command is issued by a playback, unless the submaster is in independent mode (refer to "**Independent**" above).
- + Manual assignments will be cleared when a new cue is played back on that submaster; the channels will fade out in the out fade time of the incoming cue or effect.
- + If filters are being used with the submaster, they will modify the manually assigned channels accordingly (refer to "**Function Filter (Submaster)**" on page 298).
- + The submaster must first be selected before assigning manual control. (All other submaster functions can be set without selecting the submaster.)
- + Channels may be added by manual assignment to a submaster that has channel filters. However, this does not add those channels to the list of filtered channels (refer to "**Channel Filter**" on page 297).

### Manually assign a channel, range of channels, or group using submaster touchscreen:

- Step 1. Select required channels.
- Step 2. Choose a submaster to bring up its Setup options. ("Choose" is activated by touching the specific submaster on the touchscreen.)
- Step 3. Press **<Manual Assign>**.
- Step 4. Press **<Close>** to close Setup screen.

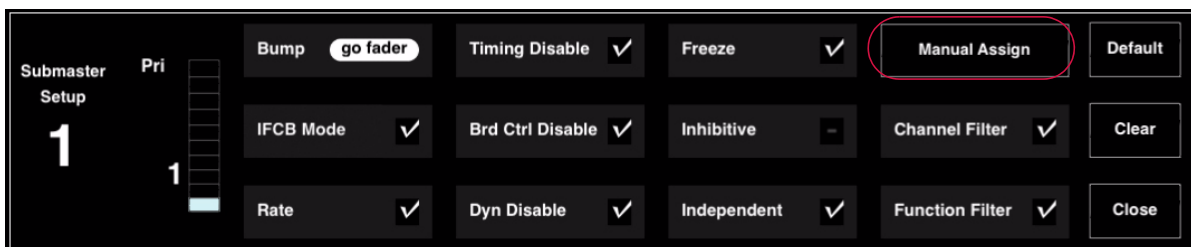

### Assign new channels to a previous manual assignment using submaster touchscreen:

The Manual Assign function is an additive process which will allow you to add channels to an existing manual assignment.

- Step 1. Select new channels.
- Step 2. Choose a submaster to bring up its Setup options. ("Choose" is activated by touching the specific submaster on the touchscreen.)
- Step 3. Press **<Manual Assign>**.
- Step 4. Press **<Close>** to close Setup screen.



### **Release a submaster from Manual Assign mode using submaster touchscreen:**

When releasing a submaster from a manual assignment, no parameter data will be changed; the channel is just no longer associated with that submaster.

- Step 1. Choose a submaster to bring up its Setup options. ("Choose" is activated by touching the specific submaster on the touchscreen.)
- Step 2. Press **<Manual Assign>** or press **<Clear>** to clear *all* submaster settings.
- Step 3. Press **<Close>** to close Setup screen.

### **Intensity Level with Manual Assign**

When channels are assigned to a submaster using the Manual Assign function, the current intensity value for the selected channels at the time of being assigned becomes the full intensity range which can be adjusted by the submaster fader.

#### *Example 1:*

If a channel is assigned while its intensity value is at 100%, the submaster fader will have control of all 100% of the luminaire's potential intensity output. Subsequently reducing the submaster fader from 100% to 50% would result in a luminaire intensity value of 50%.

#### *Example 2:*

If a channel is assigned while its intensity value is at 50%, the submaster fader will have control of only half of the luminaire's potential intensity output (scaled appropriately to the fader's full range). Subsequently reducing the submaster fader from 100% to 50% would result in a luminaire intensity value of 25%.



## Channel Filter

The Channel Filter feature is used to specify certain channels for playback on a submaster. Those "filtered" channels then become the only channels used by the submaster whenever it plays back a cue or effect.

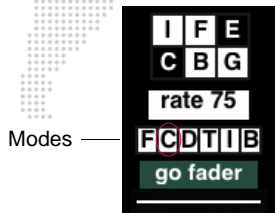

### Filter a channel using submaster touchscreen:

- Step 1. Choose a submaster to bring up its Setup options. ("Choose" is activated by touching the specific submaster on the touchscreen.)
- Step 2. Select <Channel Filter> checkbox.
- Step 3. Press <Close> to close Setup screen.

### To release a channel filter using submaster touchscreen:

- Step 1. Choose a submaster to bring up its Setup options. ("Choose" is activated by touching the specific submaster on the touchscreen.)
- Step 2. Deselect <Channel Filter> checkbox *or* press <Clear> to clear *all* submaster settings.
- Step 3. Press <Close> to close Setup screen.

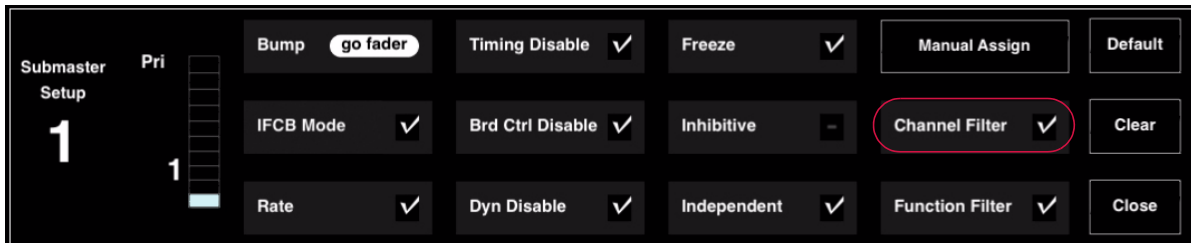

### Make submaster's channel filter the current selection:

- + Press [Chan] + submaster choose to make the submaster's channel filter the current selection.

## Function Filter (Submaster)

The Function Filter applies filters to a submaster for modification of a cue or effect during playback. The submaster Function Filter mode works in conjunction with the console's Function Filter (refer to "Function Filter" on page 93).

### Guidelines:

- + The function filter does not become active until the next event is recalled.
- + If a cue has a mask associated with it, the submaster filter state will override the mask. (All parameters will be played back, whether or not they were originally intended for playback when the cue was stored.) Refer to "Masking" on page 94.
- + If filters are modified at the Function Filter after initially assigning to a submaster, you must reapply the Function Filter to update the filter changes in the submaster.
- + Filters can be used with Effects to withhold information from cues, beams, and presets when they are part of an effect sequence. When cues are included in sequences, the cue times are used instead of attack times, unless timing is disabled in the filter selection.

Filters

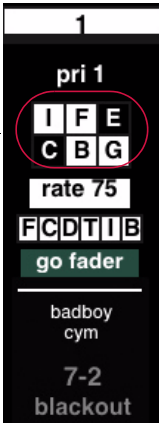

### Function Filter

<input checked="" type="checkbox"/> <input type="checkbox"/>				Wheel 2	Beam2	Edge2	E Index	Timing	Stack Separator
		Function Filter		Wheel	Framing	P Index	Effect	Dynamic	
		Z Pos		Magenta	Strobe	Prism	Index	DynOnly	Func Filter To Cue
Page 1		Tilt		Amber	Zoom	Frost	R Gobo	Misc	
All		Inten	Pan	Blue	Beam	Edge	Gobo	Sneak 3D	Filter All
Clear		INTEN	FOCUS	COLOR	BEAM	EDGE	GOBO	TO CUE	
1	2	3	4	5	6	7	8	9	10
11	12	13	14	15	16	17	18	19	20
									Filter Clear

### Apply function filters using submaster touchscreen:

- Step 1. Choose a submaster to bring up its Setup options. ("Choose" is activated by touching the specific submaster on the touchscreen.)
- Step 2. Select <Function Filter> checkbox.
- Step 3. Press <Close> to close Setup screen.

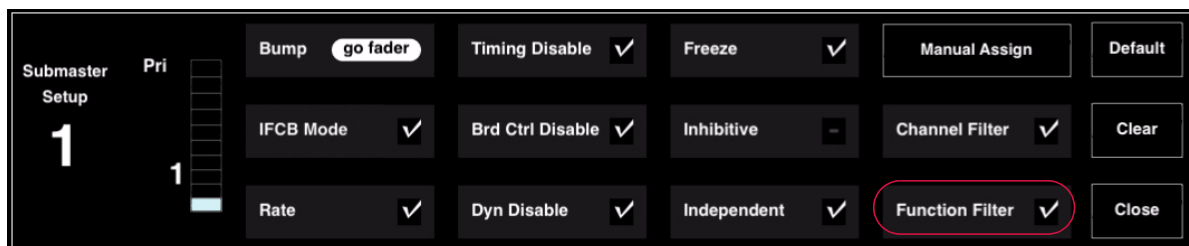

Submaster Setup 1

Pri 1

Bump go fader

Timing Disable

Freeze

Manual Assign

Default

IFCB Mode

Brd Ctrl Disable

Inhibitive

Channel Filter

Clear

Rate

Dyn Disable

Independent

Function Filter

Close

### To release function filters using submaster touchscreen:

- Step 1. Choose a submaster to bring up its Setup options. ("Choose" is activated by touching the specific submaster on the touchscreen.)
- Step 2. Deselect <Function Filter> checkbox *or* press <Clear> to clear *all* submaster settings.
- Step 3. Press <Close> to close Setup screen.

# PLAYBACK INTENSITY LEVEL

## How Playback Intensity is Determined

Earlier in this manual, intensity was discussed in relation to cue store operations (refer to "Intensity States" chapter on page 140 and "How Faders Affect Intensity" on page 254). This stored intensity state or level, along with the current setting of submaster and Grand Master faders, are used in determining the *final* playback intensity level for any given event.

As previously mentioned, the Grand Master fader is used to master the overall intensity output for the console, while the individual submaster faders control the intensity level of events being played back. Final intensity is determined by the following combination:

- + Intensity value stored in the cue or effect being played back.
- + Fader setting of the submaster being used to playback the event. (If more than one submaster is selected and their levels are different, then the HTP principle will also be involved. Refer to "HTP (Highest Takes Precedence)" on page 301.)
- + Setting of the Grand Master fader or associated [Black Out] button.

Intensity values are routed through the faders as follows:

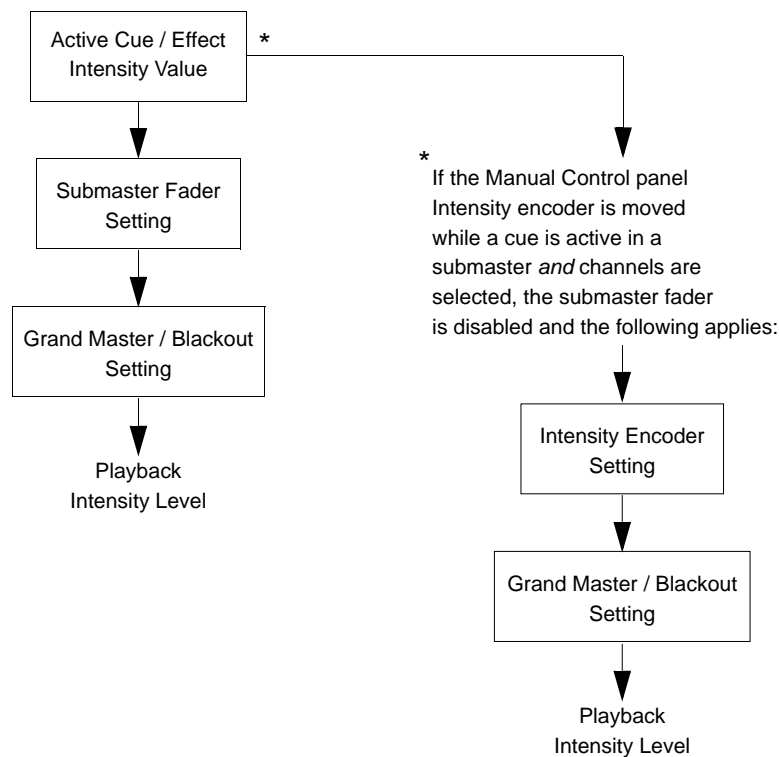



## Example Intensity Scenarios

The following examples will give you an idea how stored intensity values and fader settings work together to determine an intensity level for playback.

The final playback intensity level is a percentage of what was stored in the original cue and not a percentage of the luminaire's full potential intensity output.

---

**Note:** These simplified examples are intended to help show the relationship of intensity controls. Many more combinations are possible.

---

### Playback Scenario 1:

- Cue 52 has a stored intensity value of 100%.
- Submaster fader playing Cue 52 is set at 50%.
- Grand Master fader is set at 100%.
- Cue 52 will play back at an intensity level of 50%.

### Playback Scenario 2:

- Cue 54 has a stored intensity value of 100%.
- Submaster fader playing Cue 54 is set at 50%.
- Grand Master fader is set at 50%.
- Cue 54 will play back at an intensity level of 25%.

### Playback Scenario 3:

- Cue 56 has a stored intensity value of 50%.
- Submaster fader playing Cue 56 is set at 100%.
- Grand Master fader is set at 100%.
- Cue 56 will play back at an intensity level of 50%.

### Playback Scenario 4:

- Cue 58 has a stored intensity value of 50%.
- Submaster fader playing Cue 56 is set at 50%.
- Grand Master fader is set at 50%.
- Cue 56 will play back at an intensity level of 12.5%.

## Intensity Transitions

When playing back cues with intensity transitions (timed fades), the submaster fader can be used to scale the intensity output.

- + If the fader is set *before* the transition occurs, the entire transition will be scaled accordingly. For example, if a timed fade of 10 seconds is defined between Cue 1 (which has a stored intensity value of 0%) and Cue 2 (which has a stored intensity value of 100%), then setting the submaster fader at 50% before the transition occurs would result in a 10 second fade from 0% intensity to 50% intensity.

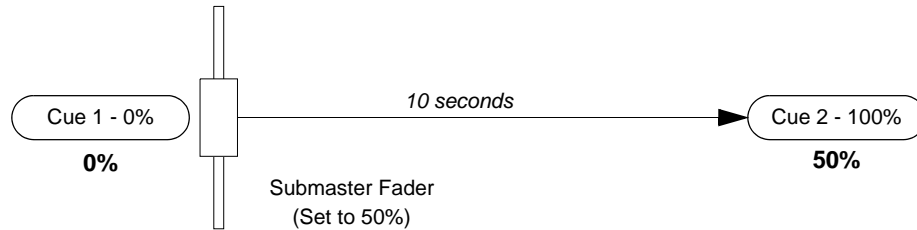

- + If the fader is moved *during* the transition, the remaining portion of the transition will be scaled accordingly. For example, if a timed fade of 10 seconds is defined between Cue 1 (which has an intensity value of 0%) and Cue 2 (which has an intensity value of 100%), and the fader is dropped to 50% halfway through the transition, then the result would be a 5 second fade from 0% intensity to 50% intensity followed by a 5 second fade from 50% intensity to 75% intensity.

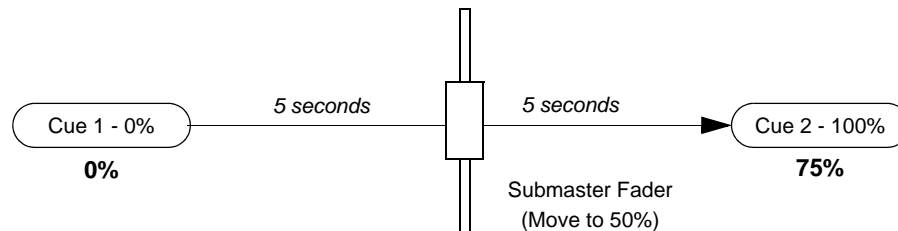

## HTP (Highest Takes Precedence)

The principle of Highest Takes Precedence is also important to understand when storing or playing back a cue. In a case of intensity conflict (e.g. two selected submasters are set at different levels), the HTP principle decides which intensity value will be ultimately applied to the luminaire. (When storing a cue, the stored value is also the result of this determination.)

Each luminaire continuously evaluates the intensity level provided by each submaster including time fades and fader position. The submaster providing the highest intensity level will determine the luminaire's actual intensity level.

# PLAYBACK

## Advanced Playback of Cues

A cue loaded into a submaster becomes the pending cue. When [Go] is pressed, the pending cue will play.

### Play a cue:

Step 1. At keypad, press [Cue] [n] [Enter] or scroll through cue list to select cue. It will be displayed in the keypad window.



- Step 2. At required submaster, press [Select] to select submaster for playback function.
- Step 3. Press [Load] to place cue in pending file (as shown in submaster display).
- Step 4. Set Grand Master fader at required level.
- Step 5. Set submaster fader at required level.
- Step 6. Press [Go] to play cue.

### Play next cue:

The submaster always sequences, placing the next sequential cue from the cue sheet or any linked cue in its pending file. Linked cues without wait times will await manual execution.

- + Press [Go] again to play next cue.

**Note:** The V276 front panel does not include the [Run], [Stop], and [Step] buttons. Perform these actions using the alternate button combinations, as given below, or use the Submaster HUD.

### Play active cue again:

- + V476/V676: Press [Run]
- + V276: Press [Cmd] / [Back]

### Play previous cue:

- + Press [Back] to play previous cue (previously active on that submaster). Subsequent presses of [Back] will step backwards through cue sheet.

### Stop a running cue / step through cues:

A running cue can be stopped and then stepped through one cue at a time.

- + V476/V676: Press [Stop/Step]
- + V276: Press [Cmd] / [Go]

**Tip** ⇨ If submaster is empty: at keypad press [cue number], then at submaster press [Go]. (Must be valid cue number.)

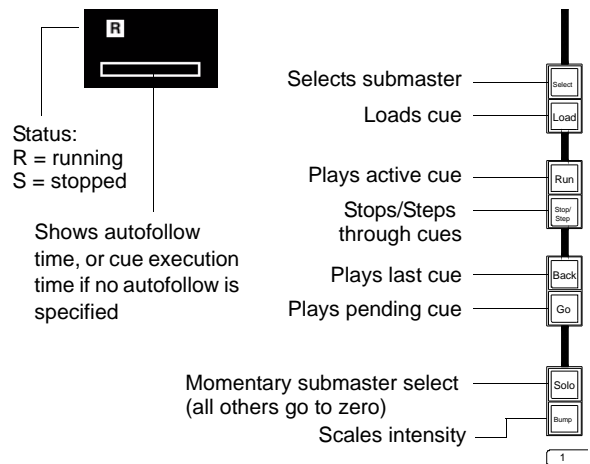
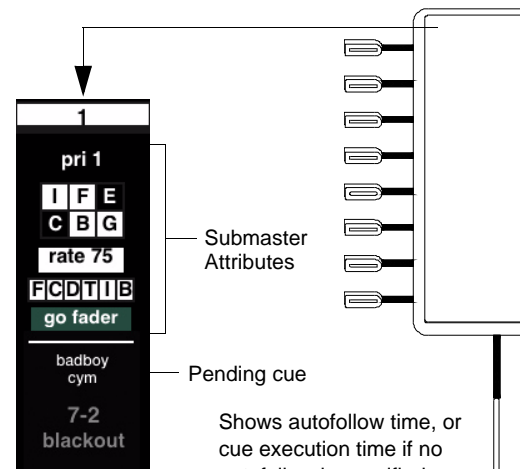

Figure 12-4: V476/V676 Submaster



## Controlling Linked Playback

The submaster always sequences, placing the linked cue in that submaster's pending file or the specified submaster's pending file. Linked cues with an associated wait time will automatically execute after the wait time has elapsed. If no wait time has been defined, the linked cue will await manual execution. A linked macro will automatically execute.

The [Stop/Step] button can be used to halt the automatic playback of linked cues which have an associated wait or trail time.

### Stop countdown of wait times (V476/V676):

Step 1. Press [Stop/Step] to stop countdown.

Step 2. Press [Run] to continue the countdown or press [Go] to advance to the next cue.

### Stop countdown of wait times (V276):

Step 1. Press [Cmd] / [Go] to stop countdown.

Step 2. Press [Cmd] / [Back] to continue the countdown or press [Go] to advance to the next cue.

## Fade Times for Marked/Zero/Out Cues

During playback, cues stored with intensity states other than *active* will assume different fade out times depending on the state.

- + Cues with *marked* and *zero* instructions will use the intensity down time associated with the channel.
- + Cues with an *out* (*inactive* state) instruction will follow the out time associated with the cue.

## Direct Mode

To assist in updating or re-storing cues, it is possible to have the command-line track the sequence of cues being executed in a submaster. Refer to "[Submaster Direct Mode](#)" on page 263.

## Copy/Move Submaster

The contents of a submaster can be copied or moved to a different submaster. This can be accomplished via the command-line or control key combinations as follows:

- + [Copy]/[Move] [Sub] n [At] m, *or...*
- + Press and hold [Copy] or [Move] then, on the touchscreen, select the source and then the destination submaster.

## Mapping Board Cue Go/Back To Submaster 1

If no board cue is pending (by selecting a board cue via the command line or the board cue window), then the board cue [Go] and [Back] buttons are mapped to Submaster 1 Go and Back. If a board cue is pending, then the board cue Go/Back will perform normal board cue controls.

---

**Note:** To clear pending board cues, enter [Board Cue] [0] [Enter] on the command line.

---

## External Fader Control via Art-Net Input

An external DMX console can be used for controlling submaster faders via Art-Net input. The "DMX In" tab, available in the Settings window, is used to configure this feature.

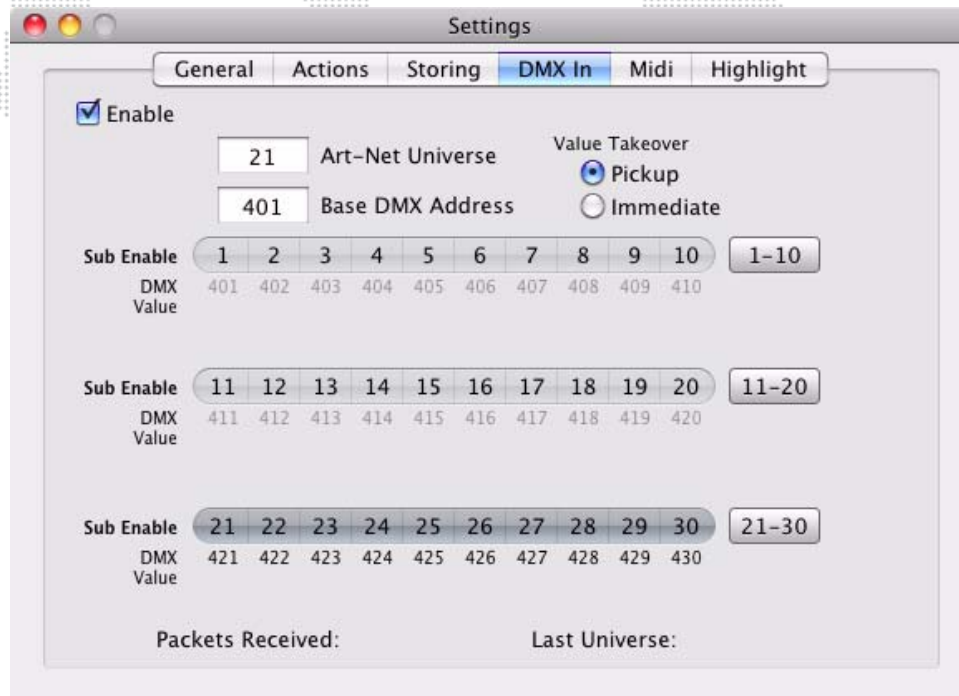

The settings tab includes an overall enable for the function, specification of Art-Net universe and base DMX address, and individual submaster control enable. The thirty DMX slots of the specified universe at the base address are mapped sequentially to the thirty Vx76 submasters. For each submaster that is enabled in the Settings window, a change in the incoming DMX value will be interpreted as a change in the fader position.

The Settings window shows the DMX slot assigned to each submaster, as well as the current value of that slot, and also indicates activity on the universe with the "Packets Received" field.

Note that the fader levels are last-takes-precedence; so moving the same fader on the console will override the DMX input until it changes. Also note that the console faders will not move to match the incoming levels, although when switching to another submaster bank the faders will go to the current levels. The Submaster HUD window will always show the current levels.

The top right of the Settings window allows you to set the "Value Takeover" behavior. This defines the logic in dealing with external fader levels that do not match the latest console fader positions. (Note that the console faders currently always work as Last Takes Precedence and do not use any pickup logic.) "Immediate" will set the submaster level to any incoming submaster value it receives as soon as it arrives. This may result in undesirable value jumps when the current position of a fader is different than that of the console. "Pickup" mode overcomes this issue by only applying a submaster level value once it has crossed the current value in the console.

For example: Sub 1 is currently at 50% with the console's fader at 50% and an external Art-Net controller's fader at 50%. The external fader is moved from 50% to 75%, making Submaster 1's level 75%.

- + With Immediate Value Takeover enabled, when the operator moves the console's fader, the value will immediately jump to 50% and continue adjustment as the fader is moved in either direction.
- + With Pickup Value Takeover, Submaster 1's value does not change until the console's fader passes 75%, at which point the submaster's value will follow as the console's submaster is moved in either direction.





**13.**

## **SYSTEM SETUPS**

This chapter provides instructions for setting console preferences, network and control settings, display settings, and multi-console system options.

- + **SETTINGS**
- + **DISPLAY FILTERS**
- + **MULTI-CONSOLE FEATURES**
- + **OFF-LINE PROGRAMMING**
- + **SOFTWARE UPDATES**

# SETTINGS

## Settings Window

The options available in the Settings window are advanced setups that are not required when first powering up and patching your system. These can be changed at any time.

### To change settings:

- Step 1. At **Setup** menu, select **Settings**. Settings window will open.
- Step 2. Click tabs to access different setting types.

Setup	Operation	Data
Settings		
Ethernet		
Pairing		
System Config	⌘K	
Calibrate Screen		
Legacy Media Setup		
Media Server Setup		

## General Tab

General console settings can be set at the General tab.

Click to reverse keypad arrow direction (reverse when box is checked)

Sets unit of measure for 3D location distances

Allows channel selection in Status windows

Specifies whether the palette number is included in its label

Sets the internal date/time stamp

Configures console for Last-Takes-Precedence operation for intensity. (LTP mode is console-wide, affecting all submasters)

Configures internal clock to take over in the event of a loss of external when checked

Selects only channels that reference the recalled preset in a cue when using Quick Focus mode

Sets the universal console Palette Cue Recall to Value or Reference

Sets the universal console Parameter display to Value or Percent

## Actions Tab

The Action settings define what the console will do at start-up or in the event communication is lost.

Tells the luminaires what to do in the event communication is lost between the console and luminaire/interface devices for more than 15 seconds

Tells the console what to do upon startup

## Storing Tab

Store settings can be set at the Storing tab.

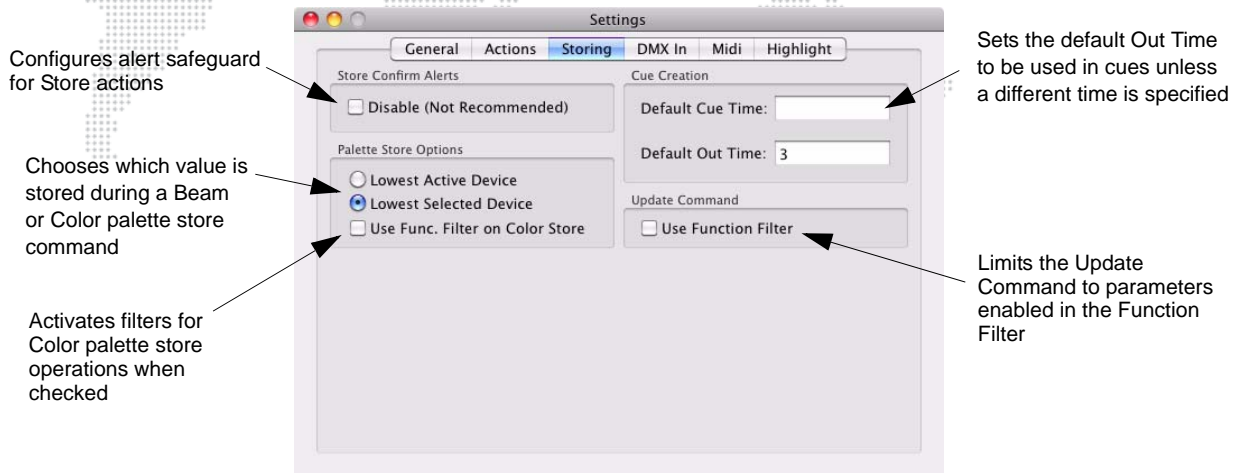

## DMX In Tab

When using an external DMX console to control submaster faders (via Art-Net input), the Data In tab can be used to enable/disable the feature and configure the settings.

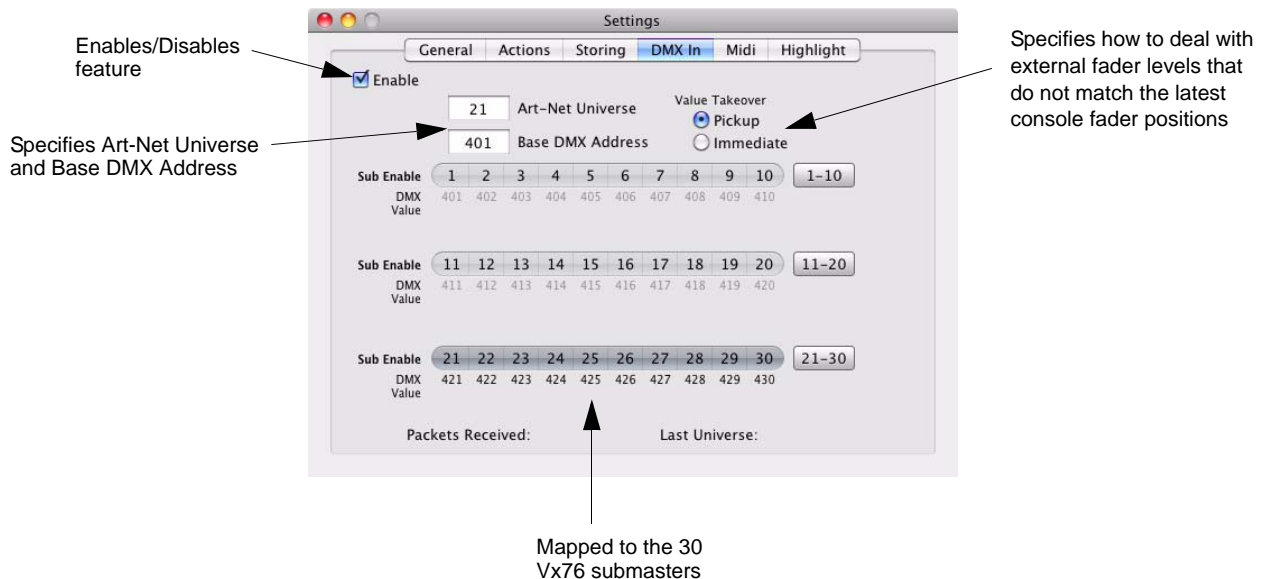

Refer to "[External Fader Control via Art-Net Input](#)" on page 304 for more information on this feature and its settings.

## MIDI Tab

MIDI options can be set at the MIDI tab.

The screenshot shows the 'Settings' window with the 'Midi' tab selected. The window is divided into 'MIDI Input' and 'MIDI Output' sections. Annotations include:

- 'Select MIDI Input Device/Port' pointing to the 'No Input' dropdown.
- 'Select MIDI Output Device/Port' pointing to the 'No Output' dropdown.
- 'When using MIDI Notes feature, these buttons select which MIDI channel it will "listen" to (1-16).' pointing to the MIDI Channel buttons (1-16).
- 'Show Control Settings' pointing to the 'Go #' Action section.
- 'The console will accept a value of either 1 or 127 for input' pointing to the 'MIDI ID (0-126)' field.
- 'MIDI Show Control Output Settings' pointing to the radio buttons for 'Off', 'Board Control Only', 'Submaster 1 Only', and 'All Submasters'.
- 'Go Command Output Options - see "Message Format" below' pointing to the 'Options' section with radio buttons for 'Go Only', 'Go Cue #', and 'Go Cue # Sub #'.

## MIDI Show Control Message Format

When a Cue Number is sent as data, additional informational fields may or may not be included as part of the complete "Cue Number" description. The option selected in the "Options" area of the MIDI window will determine how much data will be sent with the Show Control "Go" command.

The MIDI show control fields are used as follows:

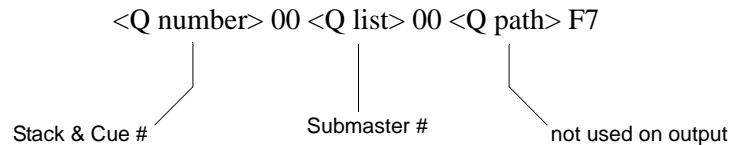

The stack and cue number (<Q number> field) is sent in "n.n.n" format. For example, cue 2-1.5 would be sent as 2.1.5.

## Highlight Tab

The Highlight feature provides a method for identifying a particular fixture or set of fixtures by putting them into a predefined state which distinguishes them from the rest of the system. The highlight and lowlight states are defined at the Highlight tab.

### Guidelines:

- + The settings are applied in sequence and can overwrite each other.
- + Items that are not checked will be ignored.
- + The default states are full intensity for highlight and no action for lowlight.
- + The user-defined highlight and lowlight states are also used for QuickFocus.

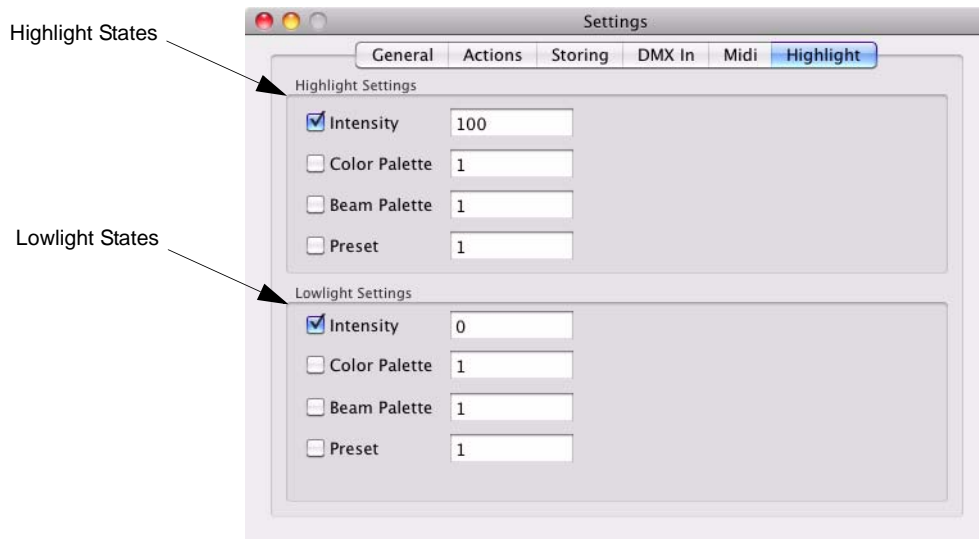



## Default Explanations

### Emergency Action

*Default:* Do nothing (remain in current state)

This setting determines what event is to occur if communication is lost between the console and the luminaire/interface devices for longer than 15 seconds. This information is sent upon console start-up in case of an emergency. You may determine one of the following:

- + Do nothing. Luminaires will do nothing.
- + Fade out in n seconds. System will fade out in the specified number of seconds.
- + Go to Cue n. Luminaires will assume the specified cue action.

### Startup Action

*Default:* No startup action

This setting determines what event is to occur upon power up of the console. You may specify one of the following:

- + Macro. Console will execute the specified macro.
- + Snapshot. Console will execute the specified snapshot.

### Date/Time Stamp

Sets the computer's internal date and time values for the console.

### Units

*Default:* English

This sets the unit of measure, used with the 2D/3D location configuration.

### Palette Store Options

*Default:* Lowest Active

This setting tells the console whether to draw data from lowest active or lowest selected channel during a Beam or Color store operation.

The "lowest active" setting draws data from the lowest channel number with intensity of that type, regardless of selection. The "lowest selected" setting draws data from the lowest selected channel number of that type, regardless of intensity state.

### Use of Filters with Color Store

*Default:* Filters not used

This setting defines whether or not function filters impact Color palette store operations.

### Buttons/Keys

This setting defines which direction the keypad cue arrows will go.

### Timecode Autoswitch

*Default:* Off

This setting defines whether the internal timecode clock will takeover or not when an external signal is lost. (Enabled when box is checked.)

# DISPLAY FILTERS

## Loading Filters

Console status windows can be configured to include data from specified channels only. Once a display filter has been loaded, only data from the specified channels would be shown in the status windows and only these luminaires would appear in the 3D Graphic window.

### Load a display filter:

- Step 1. Select only channels you wish to be displayed in status or 3D Graphic windows.
- Step 2. At front panel, press [Display Filter] toggle button (button will flash) *or* at **Special** menu, select **Load Display Filter**.
- Step 3. To load a new display filter, repeat steps 1 and 2 for different groups of channels.

### Clear a filter:

- Step 1. Clear all channel selections.
- Step 2. At front panel, press [Display Filter] toggle button *or* at **Special** menu, select **Load Display Filter**.

Special	Patch	Window	Info
Task Progress			⌘T
Clear Status Errors			
Enable Remote Focus Control			
Park			
UnPark			
Select Parked			
Encoder Fan			▶
QuickFocus			⌘F
Highlight			
Select			▶
Manual Timing			
Status			▶
Reset ( Recalibrate )...			
Home...			
Erase Luminaire Data...			
Log Network Statistics			
Update Configuration			⌘U
Store Configuration			
Clear Stored Configuration			
Load Partition			
Load Display Filter			⌘D
Auto Display Filter			⇧⌘D

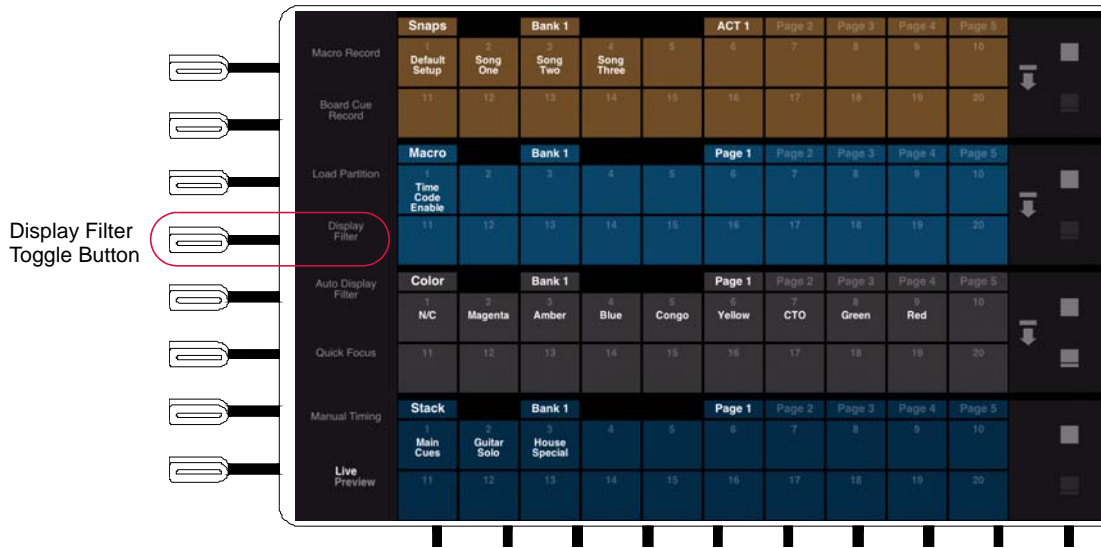

## Automatic Display Filtering

When active, the automatic display filtering feature will display data for only the selected channel(s). This is effective for all status and data windows.

### To enable display filtering:

- Step 1. At front panel, press [Auto Display Filter] toggle button (button will flash) *or* at **Special** menu, select **Auto Display Filter**. (A check will appear in menu when active.)
- Step 2. Select desired channel(s). Status and data windows will now show information for only the selected channel(s).

Special	Patch	Window	Info
Task Progress			⌘⌘T
Clear Status Errors			
Enable Remote Focus Control			
Park			
UnPark			
Select Parked			
Encoder Fan			
QuickFocus			⌘F
Highlight			
Select			
Manual Timing			
Status			
Reset ( Recalibrate )...			
Home...			
Erase Luminaire Data...			
Log Network Statistics			
Update Configuration			⌘U
Store Configuration			
Clear Stored Configuration			
Load Partition			
Load Display Filter			⌘D
Auto Display Filter			⇧⌘D
Clear Display Filter			

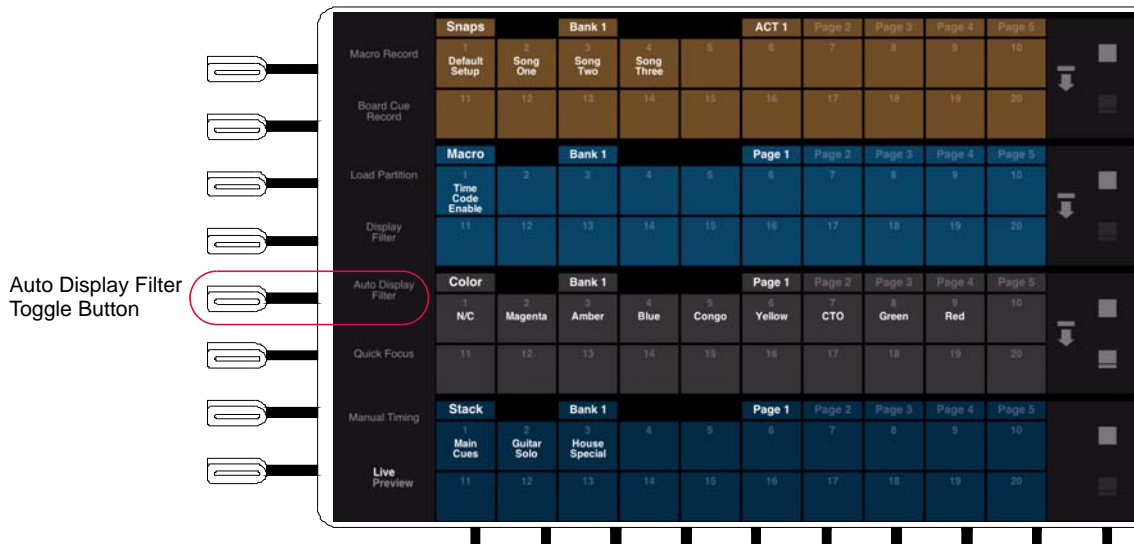





## MULTI-CONSOLE FEATURES

---

### Setting Up Backup (Secondary) Consoles

The Vx76 software allows multiple consoles to be connected together in a single lighting system. This feature can be used to ready a backup console for quick takeover of system operations in the event the main console goes down. The software allows connection of any number of secondary consoles to a single primary console, and allows mixing of V676 and V476 console models in any combination.

To configure the system for multiple console connections, it is necessary to setup one console as a *primary*. All other connected consoles would be setup as *secondary*. For example, a V676 console could be used as the main system console, while a V476 could be used as a backup.

### Primary and Secondary Setups

In a multi-console system, there are two configuration types:

- + **Primary Console.** This console serves as the main system console. It stores the show file and retains overall submaster control.  
Each system must have a primary console. Only one primary console per system is allowed.
- + **Secondary Console.** This console is "hosted" by the primary console. It receives show data from the primary and mirrors all submaster operations.  
Any number of secondary consoles are allowed. A secondary must be used in conjunction with a primary console.

### Online Backup

The online backup feature is active when a main console and a backup console are connected in a system. The online backup allows the backup (secondary) console to track all show file changes made at the main console so that if the backup console is required to takeover, the transition is seamless (without a console reset or data download to the system).

### Power Up

When powered up, a console will assume its previous configuration. The configuration information is stored along with the show file. If a system detects multiple primary consoles, a dialog will pop up requiring you to choose a single primary console. When the primary console is configured in this case, the conflicting console(s) will automatically respond to the new configuration setup.

**Tip** ⇨ It is good practice to power up the primary console first in a multi-console setup.

## Configuring Multiple Consoles

By default, in a single console setup, the console will automatically be configured as the primary console. In a multi-console setup, secondary consoles can be configured at the File menu.

### Takeover as primary console:

- Step 1. At console to become primary, at Vx76 menu, select **Takeover as Primary Console...**
- Step 2. At confirmation window, click **OK** to proceed or **Cancel** to abort.

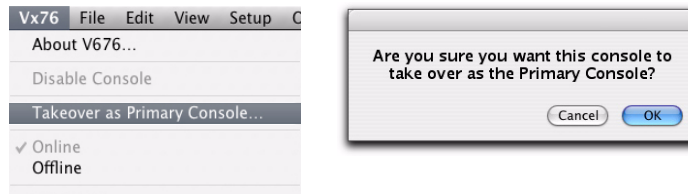

### To name a console using System Configuration:

- Step 1. Press <This Console>.
- Step 2. Touch Console Name field.
- Step 3. Enter name. For example, "Vx76" as shown below.

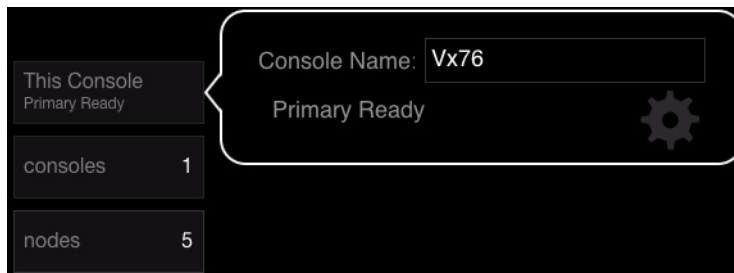

### To name a console using Version Info window:

- Step 1. At Vx76 menu, select **Versions**.
- Step 2. At name field, type a console name.
- Step 3. Close window.

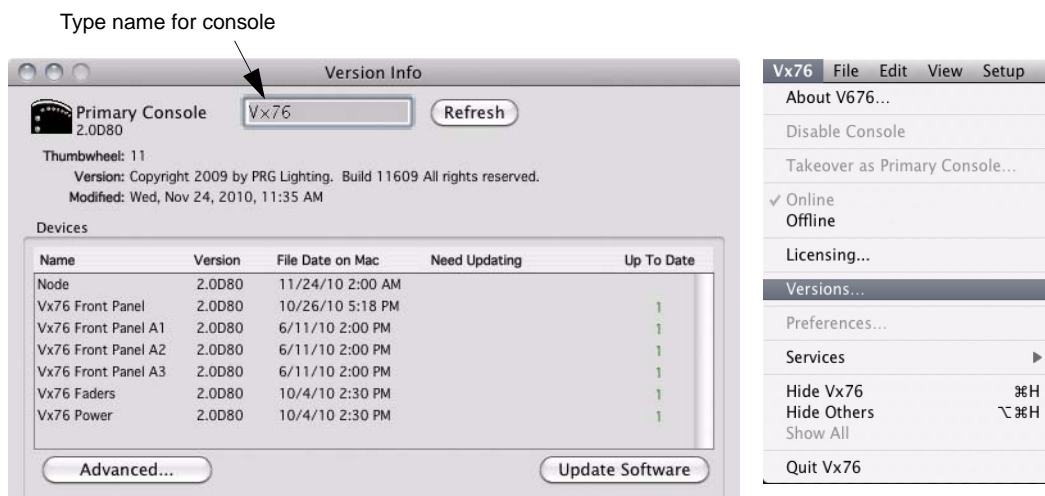

## Channel Partition

Channel partitioning allows an operator to define a specific collection of channels to work with exclusively. While a partition is loaded, only those specified channels may be controlled, stored or played back from that console.

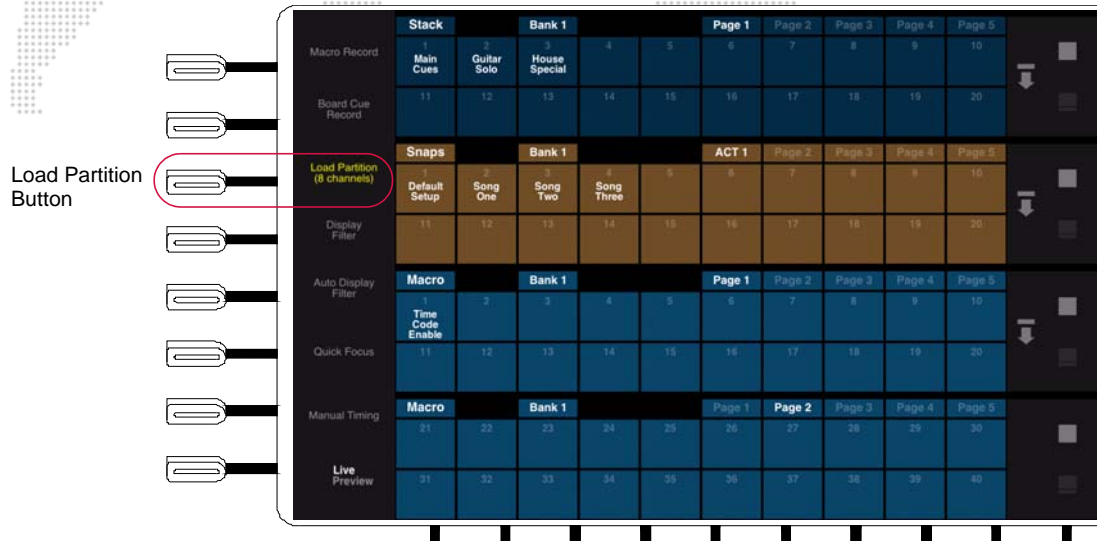

### Load a channel partition:

- Step 1. Select required channels.
- Step 2. At front panel, press [Load Partition] button or at **Special** menu, select **Load Partition**. The quick bar label will turn yellow and indicate the number of channels currently loaded in the partition.

### Add channels to a partition:

- Step 1. At Channel Select panel, select current channels by pressing [All].
- Step 2. Select channel(s) to add.
- Step 3. At front panel, press [Load Partition] button or at **Special** menu, select **Load Partition**. (Channels not currently in the partition will not light up, but will be selected to add to the partition.)

Special	Patch	Window	Info
Task Progress			⌘⌘T
Clear Status Errors			
Enable Remote Focus Control			
Park			
UnPark			
Select Parked			
Encoder Fan			▶
QuickFocus			⌘F
Highlight			
Select			▶
Manual Timing			
Status			▶
Reset ( Recalibrate )...			
Home...			
Erase Luminaire Data...			
Log Network Statistics			
Update Configuration			⌘U
Store Configuration			
Clear Stored Configuration			
Load Partition			

### Remove a channel partition:

- Step 1. At Channel Select panel, deselect all channels by pressing [Clear].
- Step 2. At front panel, press [Load Partition] button or at **Special** menu, select **Load Partition**.
- Step 3. Confirm alert.

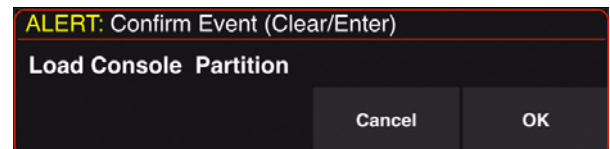

## OFF-LINE PROGRAMMING

### Performing Off-Line Programming

The Off-Line feature allows preprogramming without having to connect to a system. When in the Off-Line mode, all menus and windows are accessible just as if the system were on-line. The only difference is found in the System Configuration window, which will display errors for any of the previously connected system devices.

#### Set console to Off-Line mode:

- + At Vx76 menu, select **Offline**.

When in Off-Line mode, indications will appear in the System Configuration window, status bar, and command-line display as shown below:

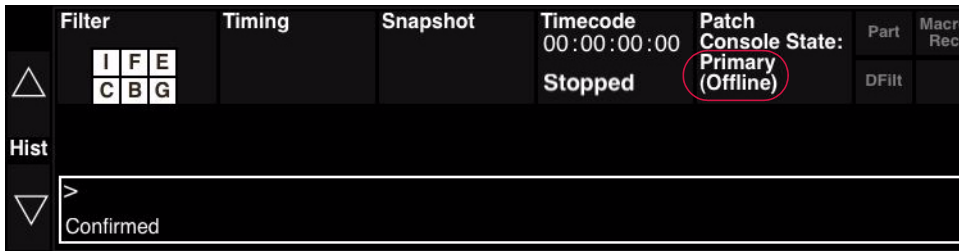
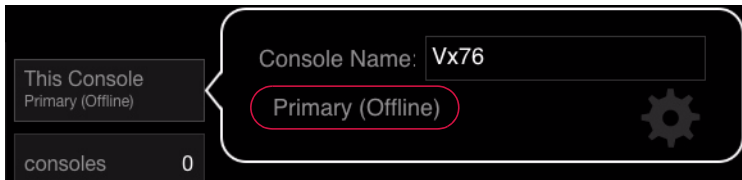
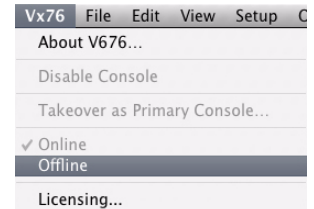

**Note:** While the system is Off-Line, the Live/Preview modes will not be available. When an off-line console is brought on-line, the Live mode will be restored by default, even if the console was previously in Preview mode.

# SOFTWARE UPDATES

## Updating System Devices

System devices can receive software updates from the console. During this procedure, new software is downloaded to all connected system devices that require an update.

The Version Info window will display the current software version and date for all connected system devices.

### To update system software:

- Step 1. Create new show file without a patch.
- Step 2. At **Vx76** menu, select **Versions...**
- Step 3. At Version Info window, click **Update Software** button. After the download is received, the connected devices will show their new software version and date.

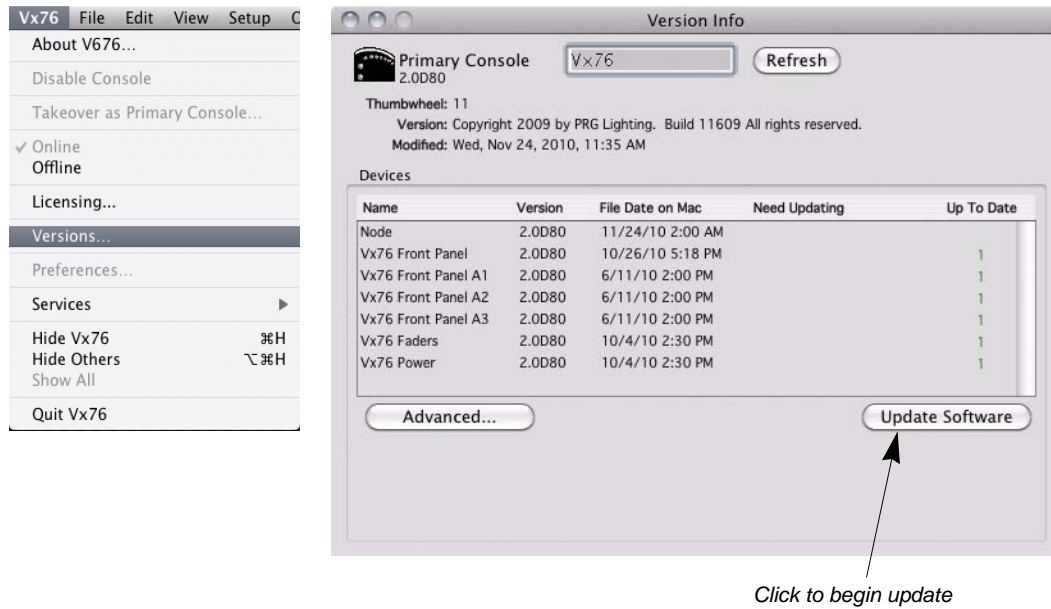



## Notes



**14.**

## **3D GRAPHIC DISPLAY**

This chapter provides instructions for using the 3D Display features.

- + 3D FEATURES
- + 3D DISPLAY WINDOW
- + LIVE/PREVIEW MODE

## 3D FEATURES

### Overview

The three-dimensional features provide graphic feedback for live, preview, and off-line editing purposes. Once patched with a 3D location, the 3D Graphic window will allow you to view your current luminaire configuration in a rendered three-dimensional representation. Luminaire status and cue positions appear in the 3D Graphic window as they would appear live and any events played back while the window is open are reproduced.

The 3D capability will allow you to define a venue size or import a model of your particular stage production so that show files can be programmed and edited according to the demands of your particular production. The 3D area displayed in the 3D Graphic window is referred to as a "venue."

The window provides numerous user-definable settings such as camera angles, ambient lighting, and rendered detail level. The window also contains built-in control interface features which allow luminaire parameter modification within the 3D graphic environment.

The 3D graphic display is based on a "point of origin," which is defined in the default venue or a venue that has been imported. When importing a venue, the point of origin used to create that 3D model would be the same point of origin used to base your luminaire 3D location in the patch setup. For each luminaire, an X, Y, and Z coordinate is defined, which locates the luminaire horizontally, vertically, and at a certain depth from the point of origin.

### Defining a New Venue

Dimensions can be defined for a three-dimensional "venue" which is a representation of your venue or stage production as defined by 3D modeling parameters. This will be the venue size used in the 3D graphic window.

#### To define a new venue size:

- Step 1. At **File** menu, select **New Venue...** Dimensions window will open.
- Step 2. Enter height, width, and depth measurements.
- Step 3. Click **OK**.

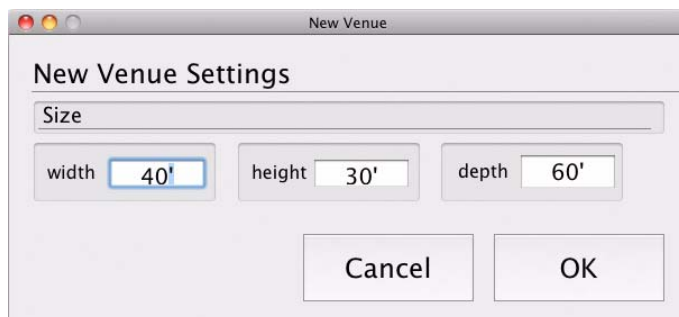
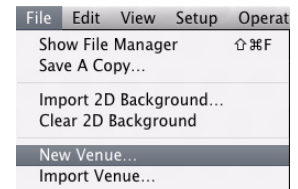



## Importing a Venue

A graphic representation of your venue or stage production can be imported for use in the 3D Graphic window. This file, referred to as a "venue", is stored with the show file. If a new venue is imported, it will overwrite the previous venue in the show file.

The venue can be created using most common 3D modeling software packages, then saved in one of the following formats for import:

- + \*.3dmf
- + \*.3df
- + \*.dxf
- + \*.dwg

---

**Note:** This version of console software does not support files in AutoCAD 2000 format or files which contain "3D solids" information. Drawings created in AutoCAD 2000 should be saved as an AutoCAD R14 drawing.

---

**Note:** When importing, it is helpful to know the point of origin on which the venue graphic is based, although it can be determined in the event this information is unavailable.

---

### Import a venue:

- Step 1. Connect external drive (containing your venue file) to console.
- Step 2. At **File** menu, select **Import Venue**.
- Step 3. At Open window, select your 3D model file and click **Choose**.

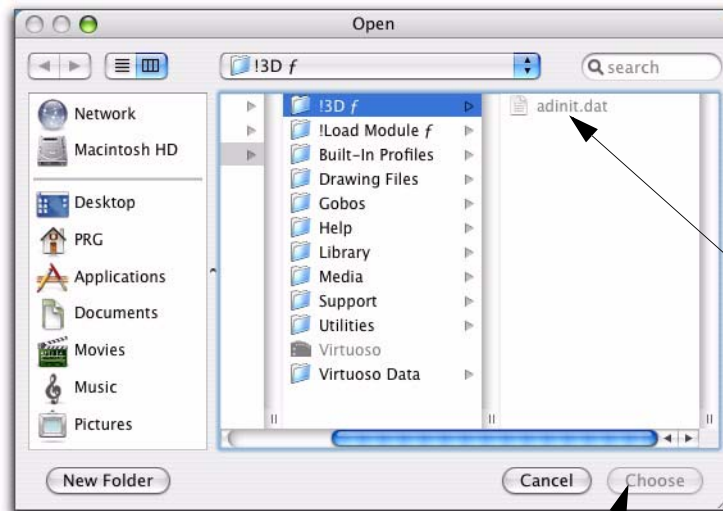
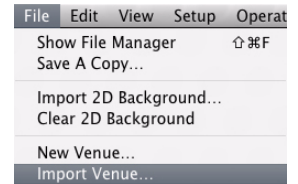

Select 3D model file

Click to import file into console's 3D Graphic window

### 3D Layer Control

The clipping process used by the Vx76 software to manage beam intersections when they meet objects in the 3D graphic can be processor intensive and slow down performance of the 3D graphic feature. As an option to speed up performance, the console offers a method for specifying individual layers of the imported \*.dwg or \*.dxf graphic not to be clipped.

---

**Note:** In VectorWorks, a layer is referred to as a "class."

---

#### To specify layer(s) for non-clipping:

- + In drawing package, rename layer starting with "-".  
For example, "-truss." When importing, the console will recognize this indicator and not clip beams when they meet objects in this layer.

### Match 3D

The Match 3D feature available in the Drawing Size window allows importing of the size and window positioning coordinates from the 3D graphic into the Plan View. (This requires that a 3D graphic has been previously imported.)

#### Import 3D specifications into Plan View:

- Step 1. At **Operation** menu, select **3D Graphic** to open 3D Graphic window.
- Step 2. At **Operation** menu, select **Plan View**. Plan View window will open and **2D Display** menu will become available on menu bar.
- Step 3. At **2D Display** menu, select **Drawing Size**. Drawing Size window will open.
- Step 4. Click **Match 3D** to import specifications.

Import specifications from Size and Window Top-Left boxes.

Click to import 3D specifications into Plan View

The screenshot shows the 'Drawing Size' dialog box with the following fields and controls:

- Size** section: Width (139') and Depth (66' 4").
- Scale** section: 1" = 3'.
- Window Top-Left** section: X (-2' 4") and Y (51').
- Match 3D** button: A button labeled 'Match 3D' with a tooltip that reads 'Match 3D requires the 3D Graphic window to be open.'
- Auto Fill** button: A button labeled 'Auto Fill'.
- Cancel** and **OK** buttons: Standard dialog box buttons.

Two arrows point from external text to the 'Match 3D' button and the 'X' and 'Y' input fields.

## 3D DISPLAY WINDOW

### X, Y, Z Locations

An X, Y, and Z location for each luminaire is defined in its patch information. These coordinates can be entered in the Location section of the Patch dialog at the time the luminaire is initially patched or any time later using the Patch spreadsheet.



Patch Spreadsheet 3D Tab

channel	fixture type	x	y	z	tilt	rotation	spin
1	BestBoy4k	0"	-34' 6"	30'	0°	0°	0°
3	BestBoy4k	3'	-34' 6"	30'	0°	0°	0°
4	BestBoy4k	57'	4' 6"	30'	0°	0°	0°
5	BestBoy4k	42'	1' 6"	30'	0°	0°	0°
7	BestBoy4k	9'	-34' 6"	30'	0°	0°	0°
9	VL2000W	0"	-37' 6"	30'	0°	0°	0°
10	BestBoy4k	57'	4' 6"	30'	0°	0°	0°
11	VL3000S	12'	-34' 6"	30'	0°	0°	0°
12	VL3000S	13' 6"	-34' 6"	30'	0°	0°	0°
13	VL3000S	15'	-34' 6"	30'	0°	0°	0°
17	VL2000W	7' 6"	-37' 6"	30'	0°	0°	0°
18	VL2000W	9'	-37' 6"	30'	0°	0°	0°
19	VL2000W	10' 6"	-37' 6"	30'	0°	0°	0°
20	VL2000W	12'	-37' 6"	30'	0°	0°	0°
21	VL3000S	16' 6"	-34' 6"	30'	0°	0°	0°
22	VL3000S	18'	-34' 6"	30'	0°	0°	0°
23	VL3000S	19' 6"	-34' 6"	30'	0°	0°	0°
29	VL2000W	13' 6"	-37' 6"	30'	0°	0°	0°
30	VL2000W	15'	-37' 6"	30'	0°	0°	0°
31	VL3000S	21'	-34' 6"	30'	0°	0°	0°

The coordinates are based on a point of origin (X=0, Y=0, Z=0) from which every object in your 3D graphic has been located. By defining all three locations, you can achieve an accurate representation of your production in the Graphic Display window.

- + X - left/right from origin.
- + Y - forward/backward from origin.
- + Z - height from origin.

**Note:** The Z coordinate (height) sets the top position for the luminaire's hook in the 3D graphic. For example, to place a luminaire on a pipe at a height of 20'-0" to the bottom of the pipe, the luminaire should be placed at 20'-2" for accurate placement.

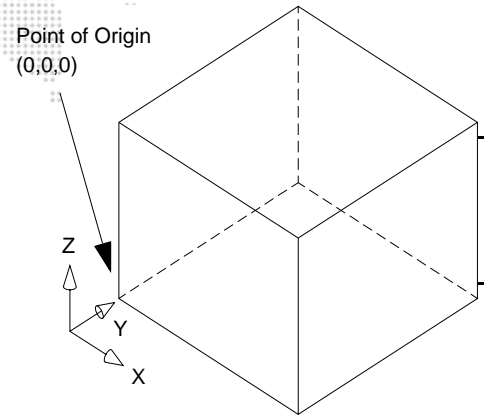

### 3D Orientation

A fixture's 3D orientation can be entered in the Orientation section of the Patch dialog at the time the luminaire is initially patched or any time later.

*Guidelines:*

- + The Patch display shows the current orientation.
- + The defaults set the orientation to common starting positions.
- + The three angular controls allow adjustment.

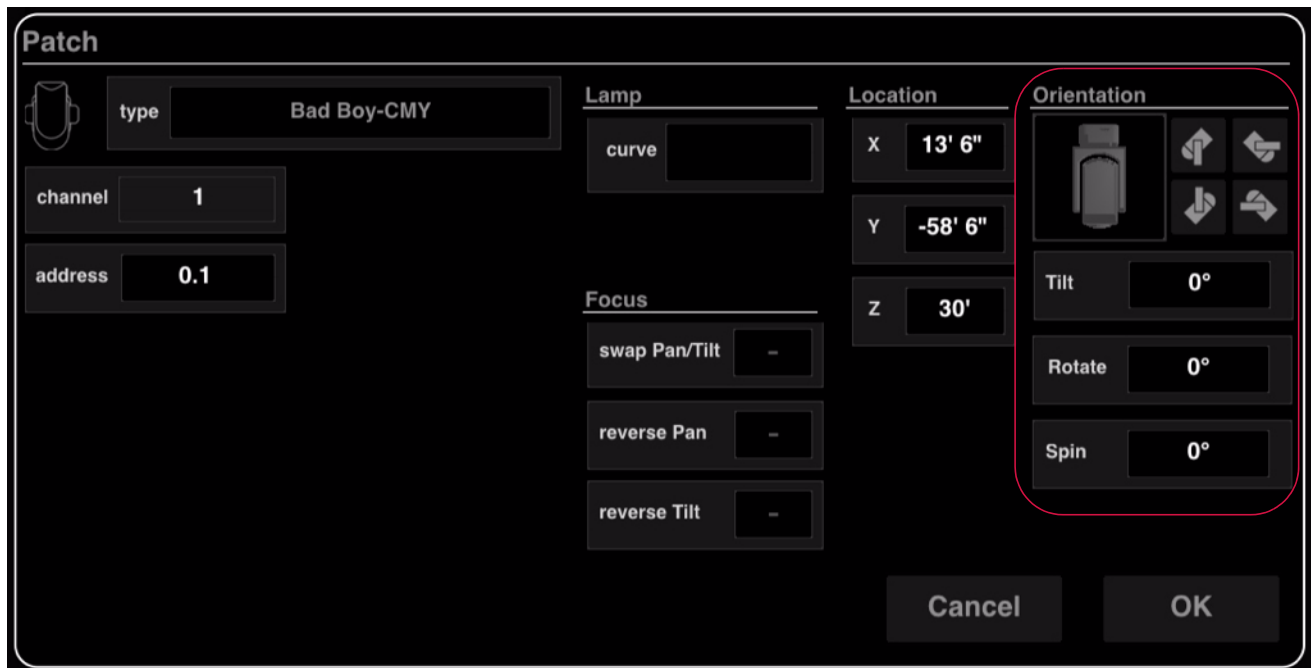

## Using 3D Graphic Window

### Overview

The 3D Graphic window displays the current luminaire configuration as a rendered, color graphic. The color feature supports both CYM mixing and LED color systems. (Note that this color feature was not available prior to Vx76 software version 2.0.)

The screen capture below shows a 3D Graphic window which utilizes the color features. These include: CMY and RGB color mixers, color wheels including split colors, beam angles via beam size iris and zoom functions, and short beam throws for use with visualizing LED arrays.

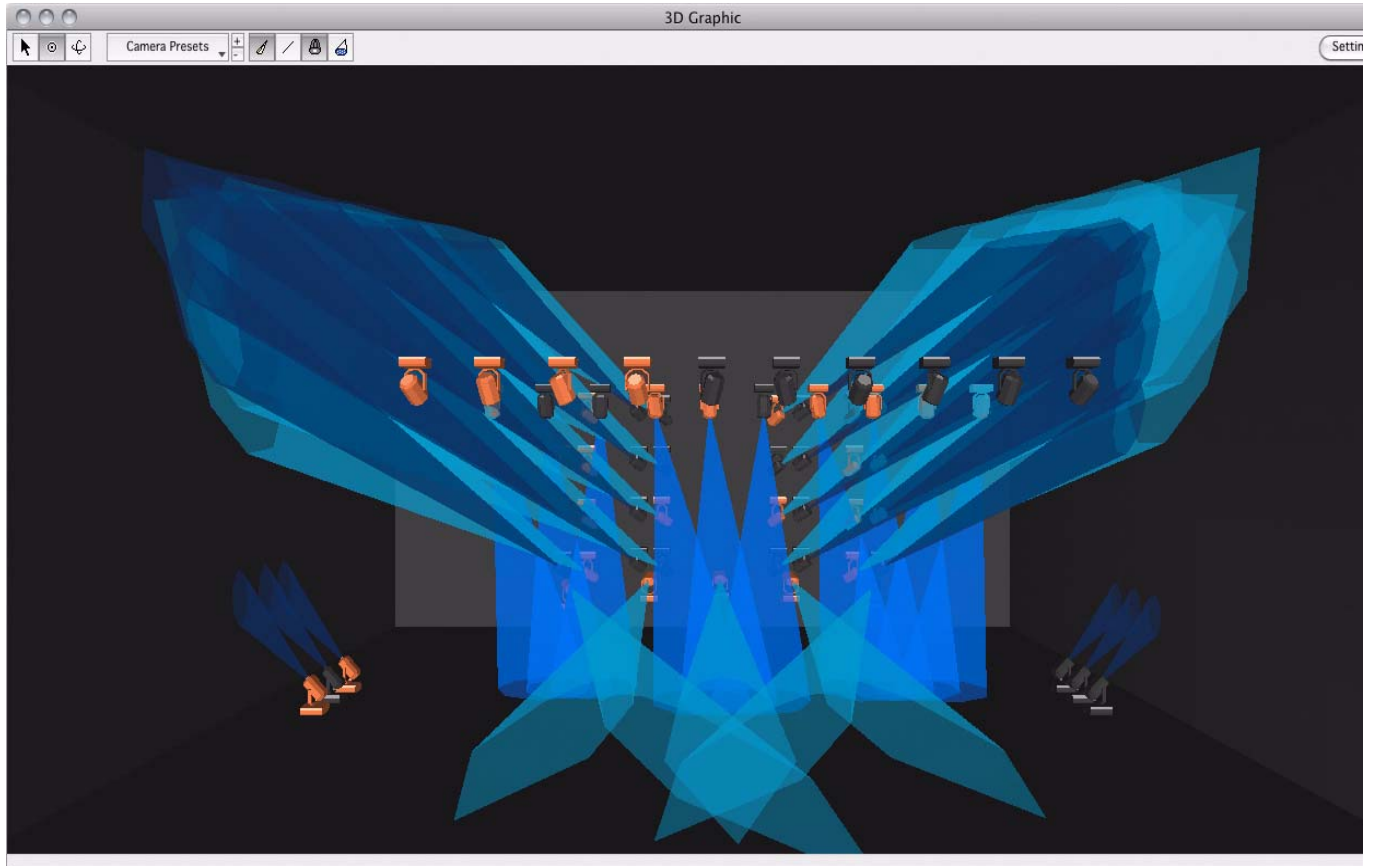

---

**Note:** If you open the 3D Graphic window without having defined a new venue or imported a venue, you will be asked to define the venue size. Refer to ["Defining a New Venue"](#) on page 320.

---

#### *Guidelines:*

- + Luminaires are focused along a focus line, which reflects the actual focus and color of the luminaire's beam. Luminaire beams can be refocused as required by indicating targets via the cross hairs.
- + Changing the focus position automatically adjusts the corresponding parameter data for all luminaires that use that focus point for positional information.
- + Smooth rendered graphics require more memory and may slow down response time depending on how many rendering options are currently active.
- + To speed up 3D graphic performance, limit the number of channels (and therefore their associated luminaires) which are displayed in the 3D Graphic window at any one time. Refer to ["Display Filters"](#) on page 311.

## Tools

Controls are available in the tool bar at the top of the window:

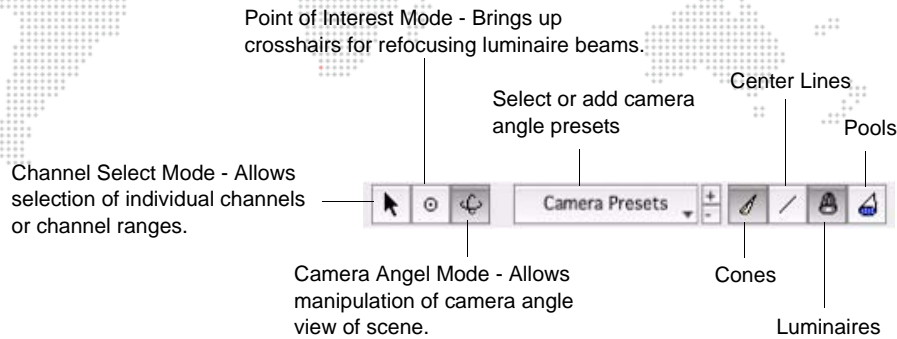

## Modes

While in **Channel Select Mode**, the following options are available:

- + Click on individual luminaires to select for manual control.
- + Hold down left trackpad button and drag cursor across a range of luminaires to select for manual control.

While in **Camera Angle Mode**, the following options are available:

- + Hold down left trackpad button while using trackpad to move camera angle up/down or right/left. (Whichever direction you move first will lock the graphic into either the up/down or right/left mode. Release button and press again to move graphic in a different direction.)
- + Hold down left trackpad button and ALT key while using trackpad to zoom in or out.
- + Hold down left trackpad button and SHIFT key while using trackpad to rotate venue.
- + Hold down left trackpad button and WIN key to bring up camera focus cross hairs. Clicking somewhere within the graphic with these cross hairs will refocus the camera angle to that center point.

When the **Center Lines Mode** is selected, the lines (beam representations) will change color according to intensity states. The following color code applies:

- + Black - Out
- + White - Full
- + Red - Zero
- + Green - Marked

## Quick Keys

The following "quick keys" can be used with the 3D Graphic window:

left arrow	3D rotate camera left
right arrow	3D rotate camera right
up arrow	3D rotate camera up
down arrow	3D rotate camera down
SHIFT / left arrow	move venue left relative to camera
SHIFT / right arrow	move venue right relative to camera
SHIFT / up arrow	move camera in
SHIFT / down arrow	move camera out

2	move venue down (camera up)
4	move venue left (camera right)
6	move venue right (camera left)
8	move venue up (camera down)
7	move venue forward (camera back)
9	move venue back (camera forward)

## 3D Graphic Settings

Appearance aspects of the 3D graphic can be adjusted using the Settings window.

### Using 3D Settings window:

- + At 3D graphic window, click on **Settings** button. Using cursor, drag sliders to adjust settings as desired.

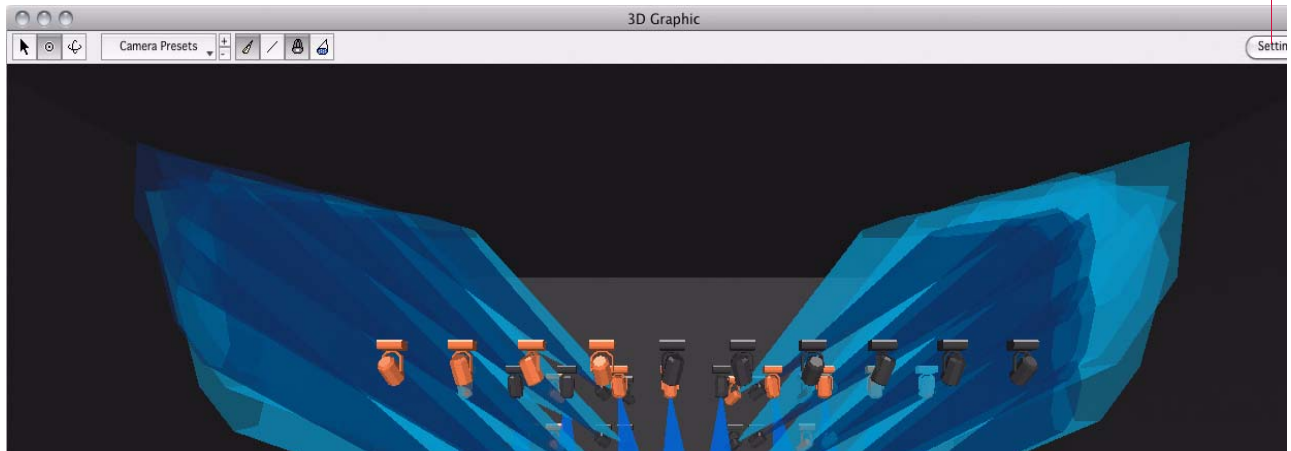
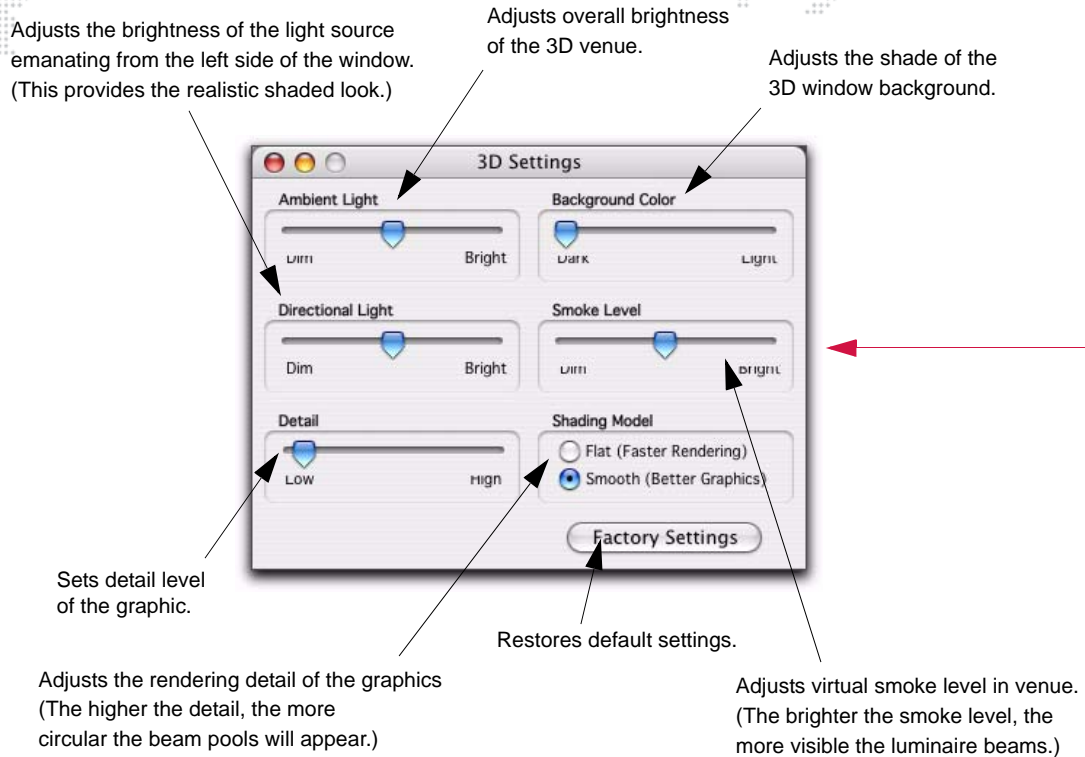

**Note:** Smooth rendered graphics require more memory and may slow down response time depending on how many rendering options are currently active.

## X/Y Control

X/Y control can be enabled for an attached track ball or other mouse device. When enabled, this will be indicated by an "X/Y Control" watermark on the monitor desktop.

### To enable track ball X/Y control:

- + At **Operation** menu, select **X/Y Control**.

### To release track ball X/Y control:

- + Click console trackpad or press ESC on the Mac keyboard.

Operation	Data	Special
Cue Sheet		
Board Cue Sheet		
Plan View		⌘B
3D Graphic		⌘C
Luminaire Status		⌘S
Tracking Changes		⌘S
Intensity		⌘I
Timecode		
Palettes		
Channel Select		
Century Palette		
Timing/Filter Display		
276 Display		
Command HUD		
Submaster HUD		
Encoder HUD		
Pan/Tilt Control		⌘;
X/Y Control		⌘'



## LIVE/PREVIEW MODE

### Overview

The 3D Graphic display, when used in combination with the console's Preview mode, is a powerful tool for previewing cues and manual control moves without actually executing them on stage.

As mentioned in Chapter 1 of this manual, the console has two special modes: Live and Preview.

The Live mode is used for live editing. While the Live mode is selected, any manual control actions or event recalls (cues, effects, dynamic states, etc.) will be executed, in real time, on stage.

The Preview mode is used for preview editing. While the Preview mode is selected, any manual control actions or event recalls are stored to the appropriate luminaires, but are not executed on stage. They are, however, visible in the 3D Graphic and Luminaire Status windows.

An indication of the current mode will appear in the status bar and command-line display as shown below:

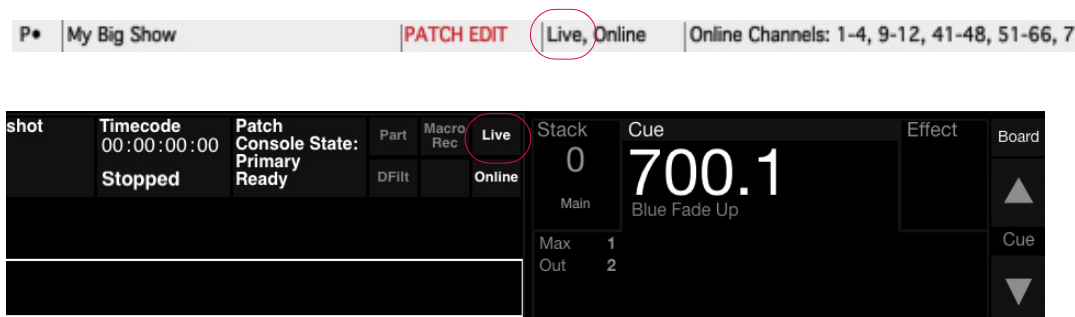

#### Guidelines:

- + The submasters are not affected by the Live or Preview mode selection.
- + Any active events on a submaster will still execute normally when Preview is selected.
- + Live/Preview modes will not be available when the system is off-line.

### Using Preview Mode

This feature will allow you to continue to play back a show, while setting up a new look which can then be saved as a cue. The Preview mode will also allow you to step through the Cue Sheet in order to preview cues in the 3D Graphic or Luminaire Status windows.

#### To use Preview mode:

- Step 1. At front panel, press [Live/Preview] toggle button. When "Preview" is highlighted, the Preview mode is on. (Any events currently active in a submaster will continue to execute.)
- Step 2. Open 3D Graphic window and/or Luminaire Status windows as required.
- Step 3. Select channels.
- Step 4. Make manual control changes or step through the Cue Sheet. Actions will be reflected in 3D Graphic and Luminaire Status windows.
- Step 5. If required, store changes as a cue.

Step 6. Press [Live/Preview] toggle button again to return to Live mode. (When "Live" is highlighted, the Live mode is on.)

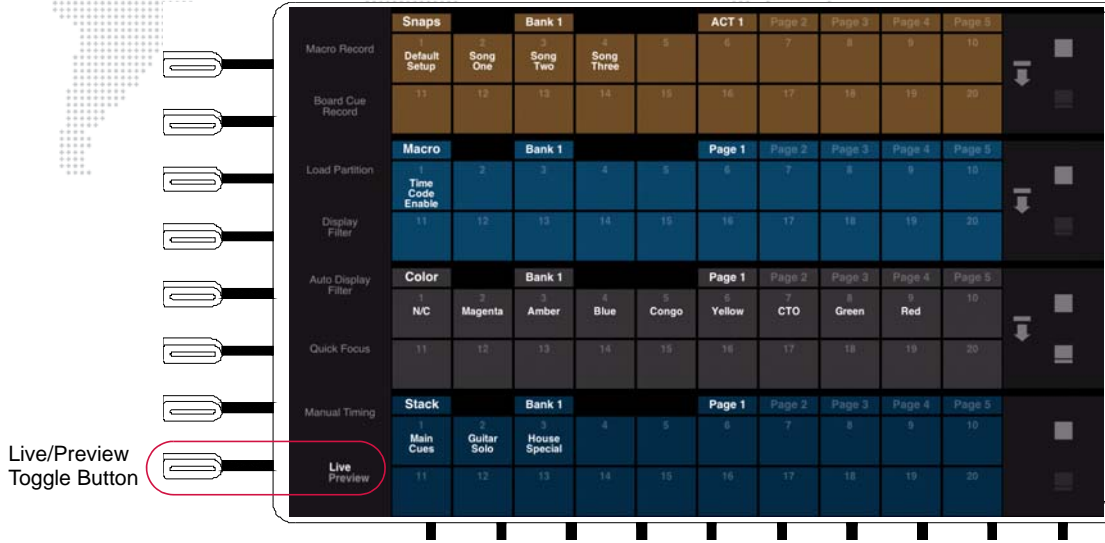



**15.**

## **SHOW MAINTENANCE**

This chapter provides instructions for managing show files, importing/exporting patch data, updating the operating system, and using the off-line diagnostics.

- + **SHOW FILE AND DATA MANAGEMENT**
- + **UPDATING PROFILES**
- + **ON-LINE DIAGNOSTICS**

# SHOW FILE AND DATA MANAGEMENT

## About Show Files

All programming information for a production (i.e., a show) is stored in a *show file*. Show files are made up of individual data files nested within a show file folder. When the Vx76 software application is launched, it will automatically open the last show file used on the console, unless one is not available, in which case a new show file is automatically opened.

Show files can be managed by one of two methods: 1) using the Utilities screen available in the console's central touchscreen, or 2) using the Show File Manager window available in the Mac menu bar. These controls allow show files to be opened, duplicated, renamed, deleted, imported, and/or archived to an external storage device.

## Working with Show Files

### Utilities Screen

The central touchscreen Utilities screen is used for show file management. (The functions are the same as the Show File Manager Mac window.)

- + Press the <Utilities> button on the touchscreen to open the show file controls.

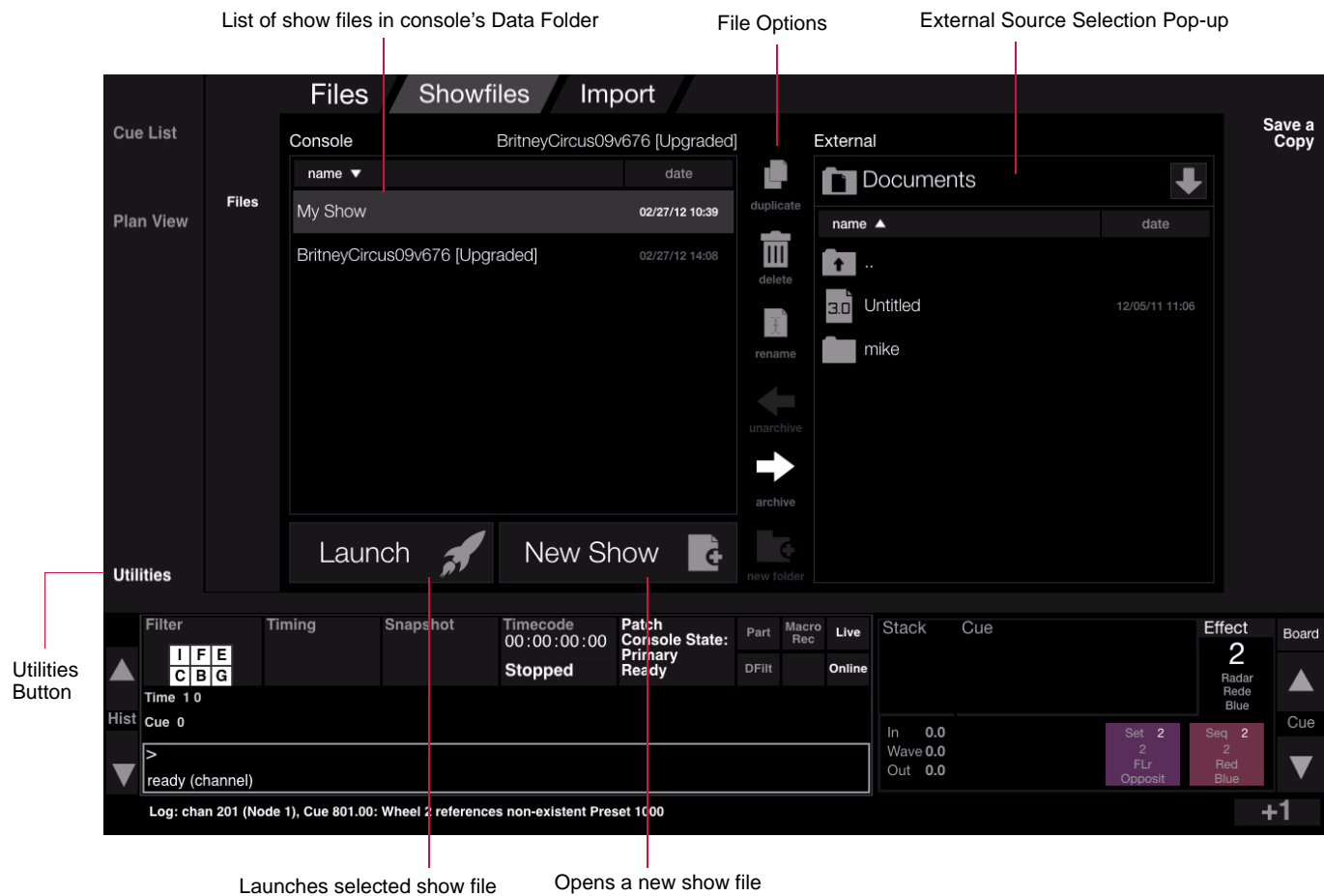

### To open a new show file:

A new show file can be opened at any time.

- + At Utilities screen, press <New Show> button.

**To open an existing show file stored on the console:**

Show files stored on the console's hard drive can be selected from the left "Console" column.

- Step 1. At left "Console" showfile list, select show file.
- Step 2. Press <Launch> button to open.

**To open an archived show file stored on an external source:**

If a show file is selected on an external source, pressing the <Launch> button will automatically unarchive and launch the file in one step.

- Step 1. At right "External" showfile list, select an external source using pop-up menu.
- Step 2. Select archived show file.
- Step 3. Press <Launch> button to unarchive and open.

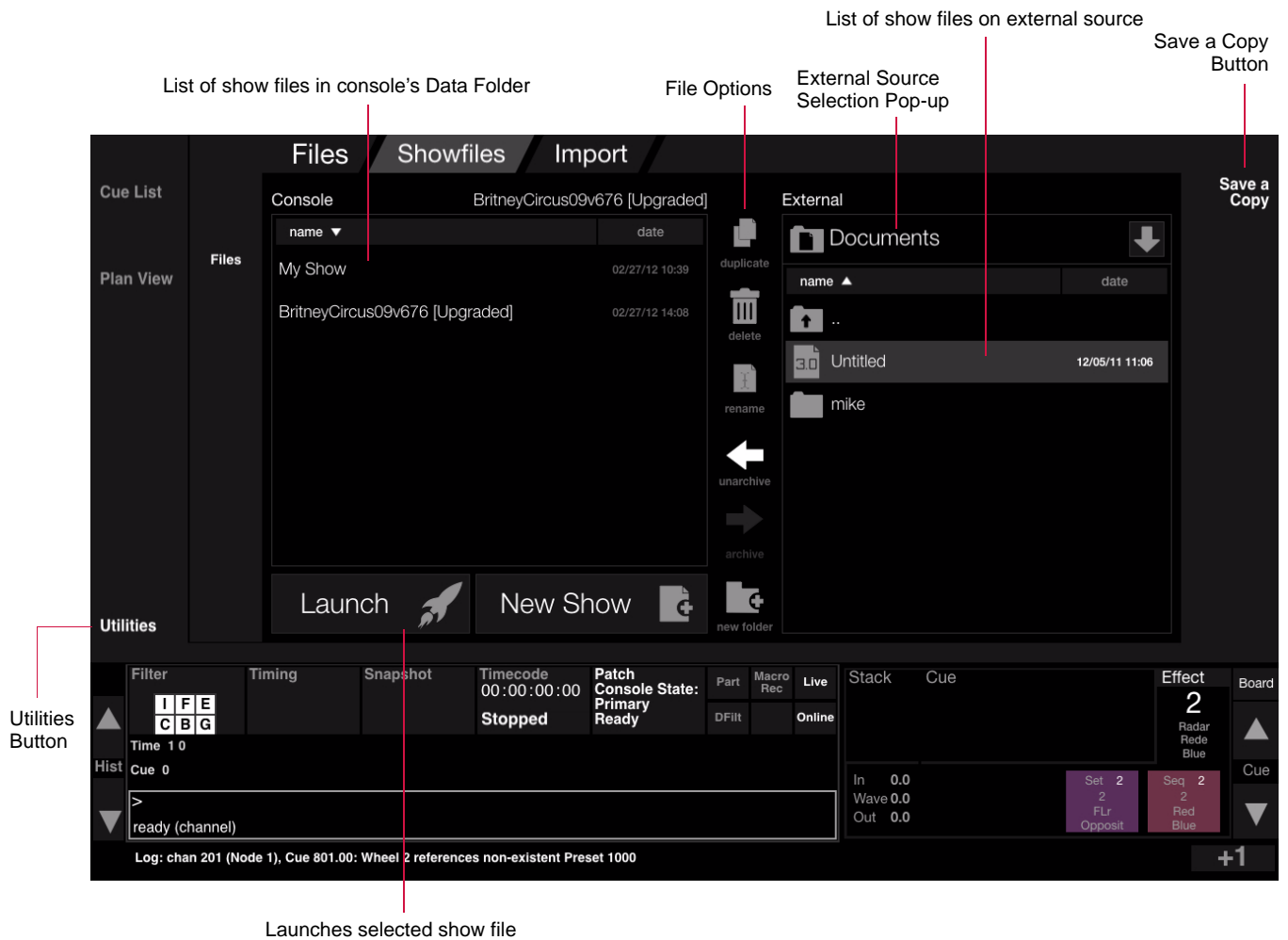

**To rename, duplicate, or delete a show file:**

Only show files resident on the console's hard drive can be renamed, duplicated, or deleted.

- Step 1. At left "Console" showfile list, select show file.
- Step 2. Press <Delete>, <Rename>, or <Duplicate> button as required. (Delete will require a confirmation.)

## To archive a show file:

Show files can be backed up (archived) to an external storage device.

Step 1. At left "Console" showfile list, select show file to be archived. (Additional option icons will be made available.)

Step 2. At right "External" showfile list, use pop-up to select an external location where the archive is to be stored.

Step 3. Press <Archive> button. Show file will be copied to the external location. (This may take a few moments.)

## Import Show Data

Data can be imported from one show file to another using either the general Import feature or the Selective Import feature. If fixture profile information is present in the incoming show file data, then patch information cannot be imported at the same time. In this case, the patch must be imported first (refer to "Importing Patch" on page 340). During an import, fixture type conversion will automatically take place. If fixture types don't match, the console will automatically convert to the best possible match.

---

**Note:** Associated Cue Snapshots and Notes are imported with an Import Cue Range action. The Patch selection imports 2D background data and 3D selection imports 3D venue data. If there is no 2D or 3D venue data, then only the Patch and Camera presets will be imported.

---

## To import show data:

To import data, first press the <Import> button at the top of the central touchscreen display, then choose either import "all" or "selective."

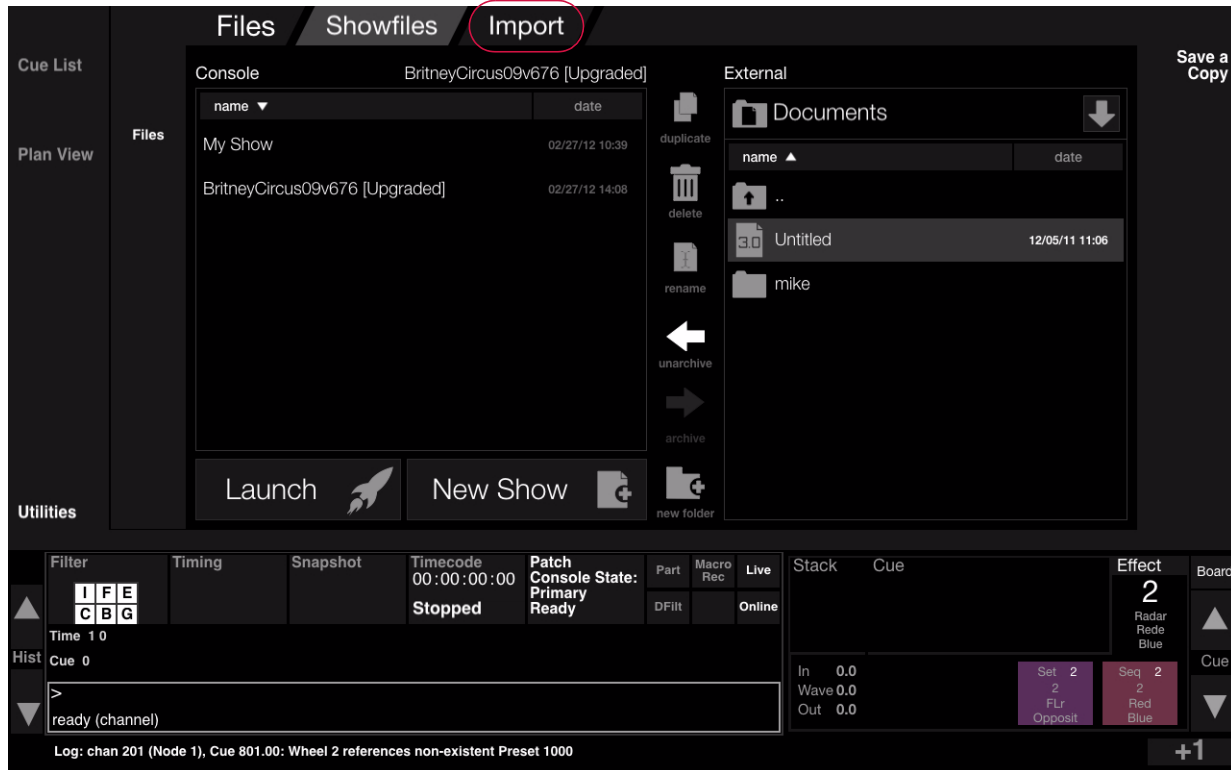

## Import All

This option imports entire sections from another show based on the selections.

- Step 1. Press the <all> button, then choose the sections to import (patch, cues, snapshots, etc.).
- Step 2. Press <Import Data> button to import.

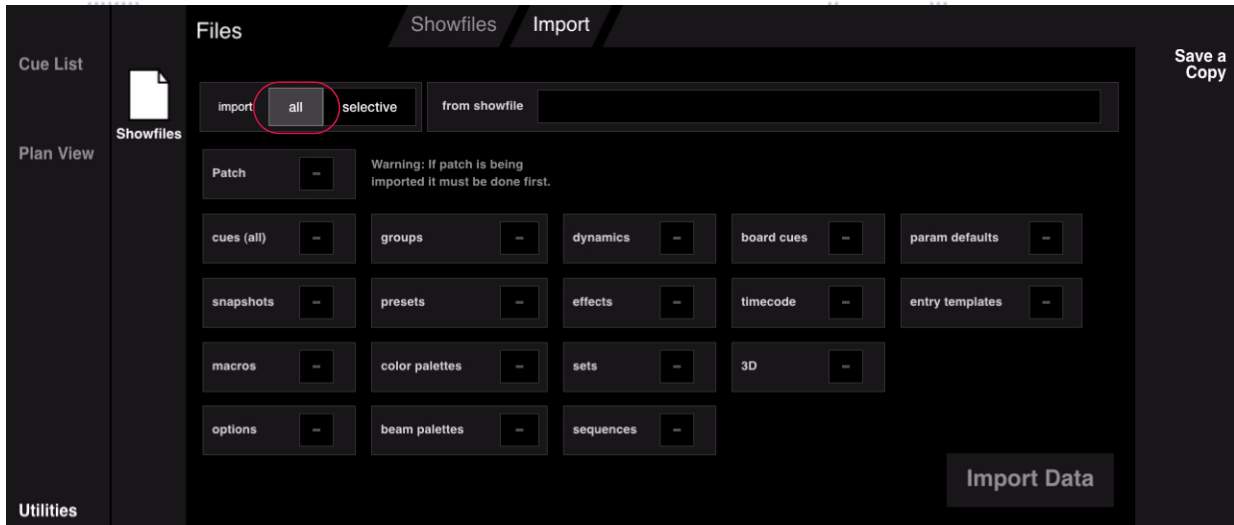

## Selective Import

This option imports a range of items of a specific type from another show.

- Step 1. Press the <selective> button, then specify the type and range.
- Step 2. Press <Import Data> button to import.

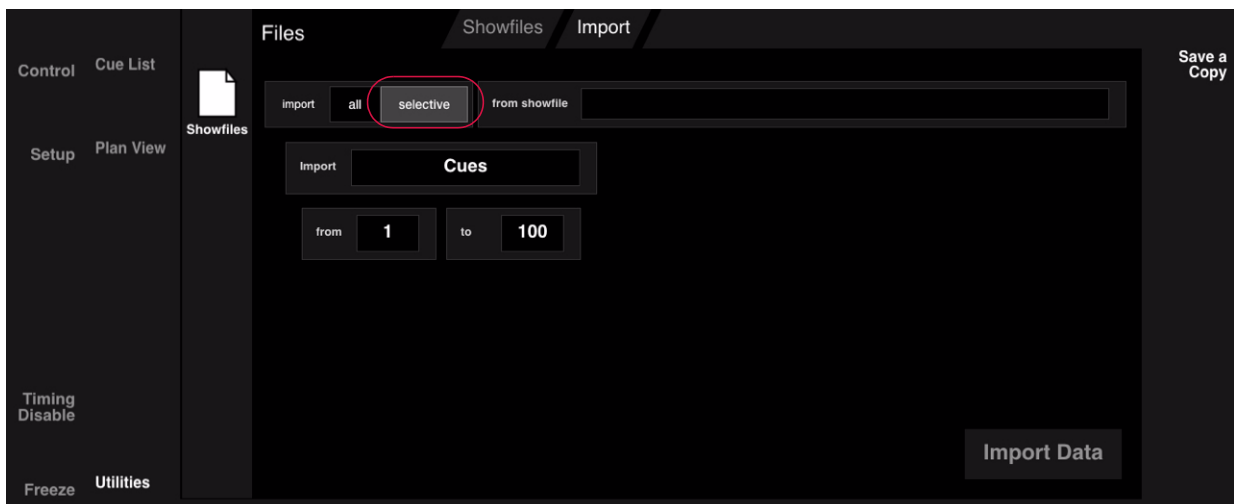

## Importing Cues

This feature allows the import of cue data from another show file for channels of the same type and same control channel. This is useful to recover cues from a backup file in the event they have been accidentally stored over. When starting a new show file, it can also be useful to import either all cues for all channels or just some of the cues for the selected channels.



## After Cue Import

If cues have been built using Presets, the Cue Data and Status windows will show the source Preset ID. If Presets were not imported, there will be no Preset data present/available for the luminaires. In this case, there may be a log message indicating that channels could not recall data because there was no Preset data. The error message in the log will be: "device," channel XXXX, cue references non-existent Preset ID XX.

Importing Presets will delete existing Preset data in the show file and replace it with the imported data. Instead, it may be an advantage to recreate the Presets to avoid losing the current data.

With the **All Cues, All Channels** option selected, all data will be imported for the patched channels. If the type does not match, then data will be deleted. This option disregards channel selection and any existing cue data will subsequently be lost. Preset data may also be required.

With **Selected Channels** selected, only the specified cue or range of cues will be imported for the selected channels. It is also possible to bring in Cue Notes and Cue Snapshots that are applied to those cues. Preset data may also be required.

---

**Note:** Cue numbers, effects, etc. loaded by an imported Cue Snapshot may not exist in the current show file.

---

If importing Effects, where the Sequence steps are made up of cues, there may be issues if the cue data is different or if the cue number does not exist. If the data does not exist, the error message in the log will be: Error: "Device," attempted recall of invalid\10.

## Importing Palette Data

Importing beam and color palettes for DMX512 fixtures (using "**Import Show Data**" on page 334) can lead to corrupted data if the patch is not the same. Likewise, if palette data is imported prior to creating a patch, corrupted data could occur. This corrupted data will result in incorrect values and parameters when recalling some beam and color palette data.

Two commands are available to repair bad data (any occurrence of 'Unk' in the data section of the palette windows is considered bad data). These commands are **Cleanup Palette**, which removes "Unk" (unknown) fixture type data, and **Revert to Defaults**, which deletes existing data and restores from profile (if present) for the selected luminaire type. The correction is performed independently for the selected palette, so if cleaning both beam and color, commands should be performed on both.

Refer to the following pages for instructions on using these commands.



## Cleanup Palette

This command can be used to remove any occurrences of "Unk" fixture types in the palette window which may have happened during a data import.

### To cleanup a palette:

- Step 1. To enable Cleanup Palette command, ensure that either palette data window is open and at top level (in front of all other windows).
- Step 2. At **Data** menu, select **Cleanup Palette**. This will bring up a confirmation alert.
- Step 3. At alert window, click **Cleanup**. This action will remove "Unk" fixture types.

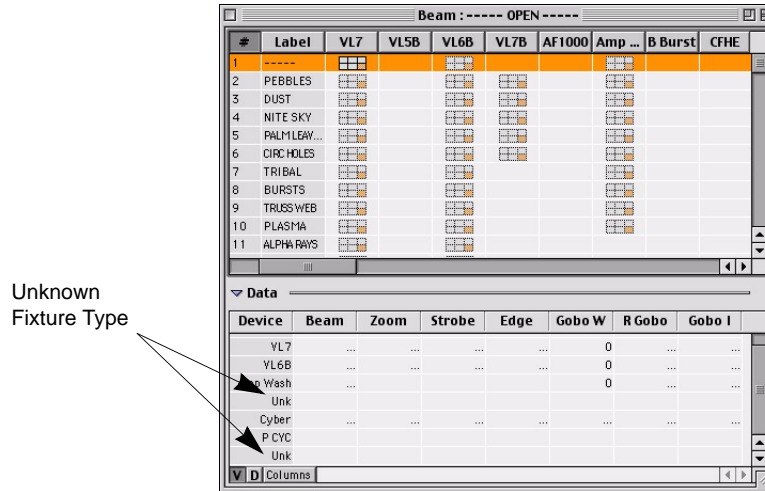
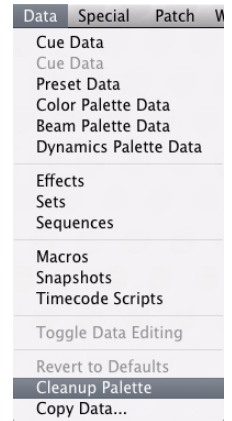

## Revert to Defaults

This command can be used to delete bad palette data and duplicate fixture types. This will restore defaults from the profile (if present) for the selected fixture.

### To revert to defaults:

- Step 1. To enable Revert to Defaults command, ensure that either palette data window is open and at top level (in front of all other windows) and a fixture type is selected in palette window.
- Step 2. At **Data** menu, select **Revert to Defaults**. This will bring up a confirmation alert.

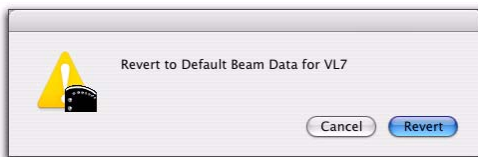

- Step 3. At alert window, click **Revert**. (Palette data may need to be recreated.)

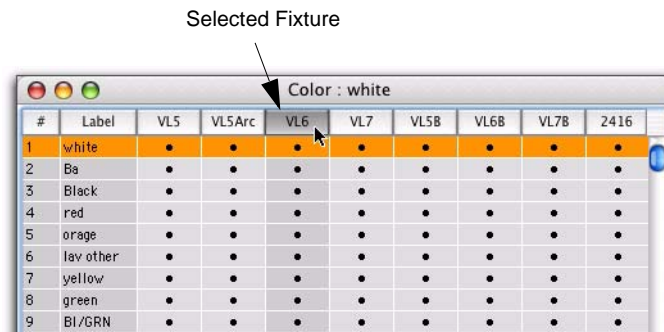

## Save a Copy

"Save a Copy" creates a backup of the active show file. This can be done via the Utilities screen or via the Mac menu.

### To save a copy of the active show file using Utilities screen:

- Step 1. While a show file is open, press ⌘S (Save a Copy).
- Step 2. Type a new file name or use default name.
- Step 3. Press ⌘S (Save).

### To save a copy of the active show file using menu:

- Step 1. While a show file is open, select **Save A Copy** at the File menu. Save As window will open.
- Step 2. Type a new file name or use default name.
- Step 3. Click **Save**.

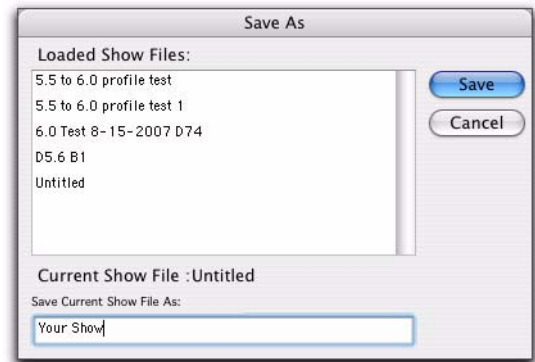
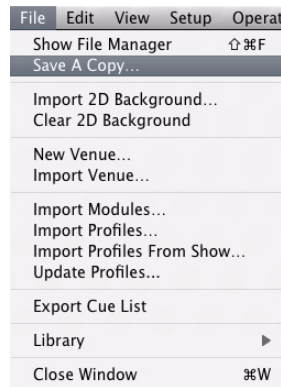

## Show File Manager Window

The Show File Manager software window (available at the File menu) is also used for show file management. (The functions are the same as the touchscreen Utilities screen.)

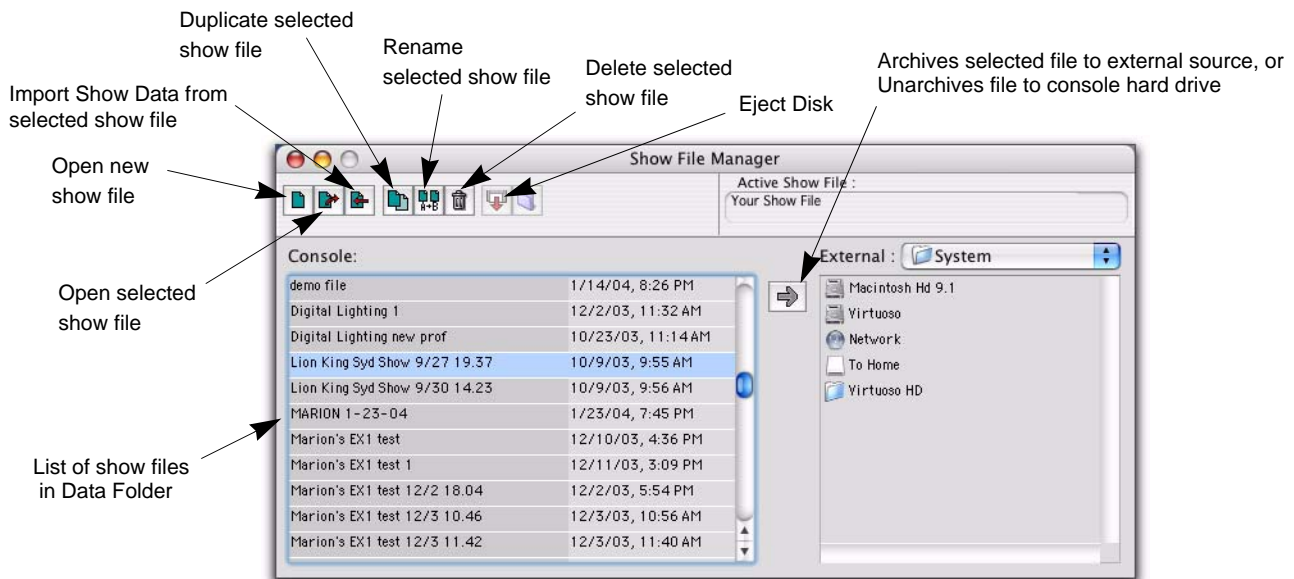

## USITT ASCII Show File Import

The stand-alone ASCII Import application provides a method for importing conventional patch, cues, submasters, and groups from show files built on Strand, ETC, and grandMA consoles.

The ASCII Import application is located in the Support folder of the Vx76 application folder. (Note that the Vx76 software must be running on Mac OS X 10.7 or higher for this application to run.)

The interface window offers three buttons for importing data:

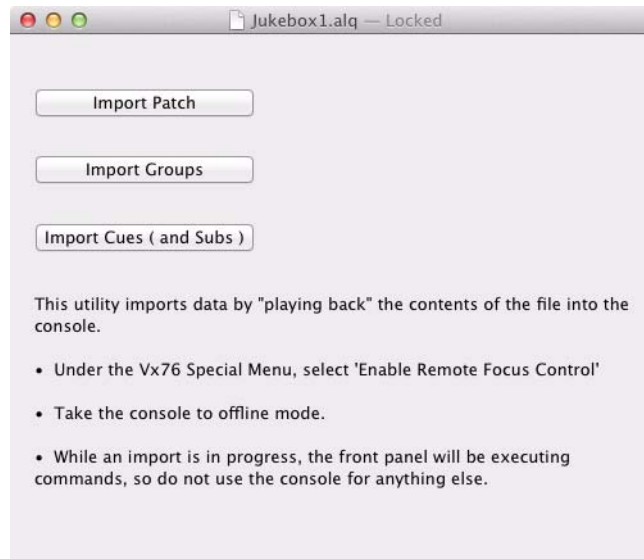

- + **Import Patch** - Imports patch data for the conventional fixtures in the show file.
- + **Import Cues (and Subs)** - Imports all cues to the main cue list. Submaster information will import to cue stacks; Sub 1, 2, 3 to Stack 1, 2, 3 respectively.
- + **Import Groups (Presets)** - Imports all groups and converts them to presets.

### To import show files:

- Step 1. Start with an empty Vx76 show file.
- Step 2. At main Vx76 application, select **Enable Remote Focus Control** from **Special** menu.
- Step 3. Place Vx76 console in offline mode by selecting **Offline** from **Vx76** menu.



- Step 4. Open ASCII Import application (located in the Support folder in the Vx76 app folder).
- Step 5. Open show file as prompted by the file manager. Once the file is opened, the import interface will appear.
- Step 6. Use interface to import data as required.

---

**Important!** While an import is in progress, the front panel will be executing commands, so do not use the console for anything else during this time.

---

## Exporting Patch

Patch data can be exported as text information from a show file for import into other show files or programs.

### To export patch data:

- Step 1. At **Patch** menu, select **Export Patch...** File management window will open.
- Step 2. Select a location and name your patch file.
- Step 3. Click **Save**.

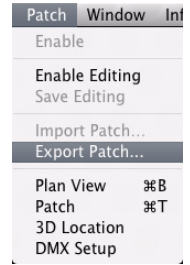

## Importing Patch

Patch data exported from a show file may be imported into a different show file. The patch data file can be resident on the hard drive or portable disk.

---

**Note:** The **Import Patch** option will only be available when patch **Enable Editing** is selected.

---

### To import patch data:

- Step 1. At **Patch** menu, select **Enable Editing**.
- Step 2. At **Patch** menu, select **Import Patch...** File management window will open.
- Step 3. Locate and select required file.
- Step 4. Click **Choose**.

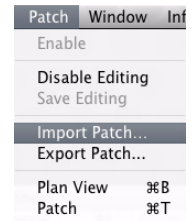
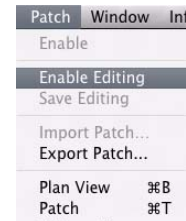

---

**Note:** For instructions on importing a 3D venue, refer to "**Importing a Venue**" on page 321.

---

## Console Log

The Console Log contains information such as calibration failures, programming data, cue repair summaries, and save reports. The Log can be viewed in the Log window (available at the **Setup** menu). Log messages are also posted as they occur on the front panel and in the software status bar.

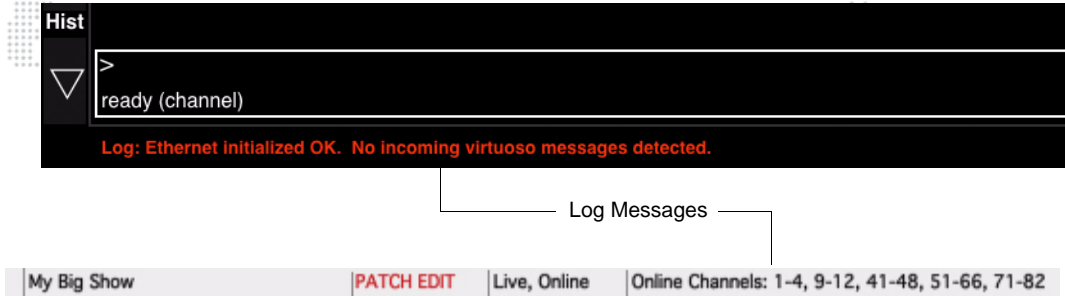

**Note:** The log has a limit of 1Mb. After it is full, messages will no longer be logged, although they will still appear in the information bar as they occur. Press **Clear** to empty log so that new messages will be displayed.

### Using Log window:

- + At **Setup** menu, select **Log**.
- + Click checkboxes to display desired information (Errors, Configurations, Notes, Debug info, and/or Events).
- + Click **Clear** to clear all messages.
- + Click **Export** to export information.
- + Use font controls to customize the display.
- + Use the Search tool to search for specific entries.
- + Click the **Print** icon to print the log.

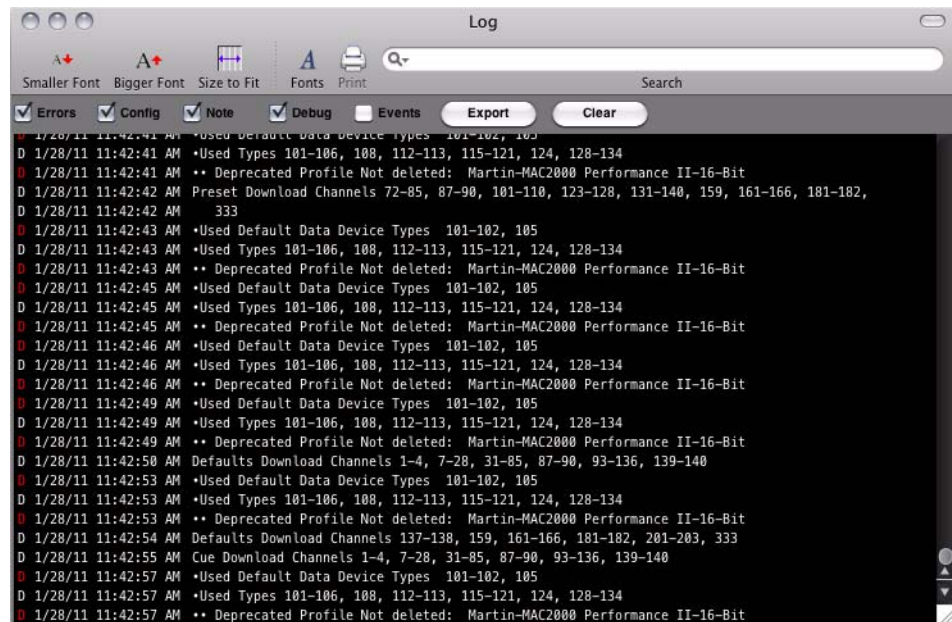
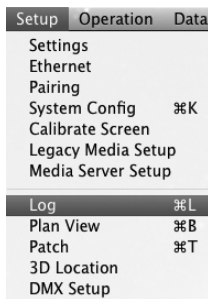

## Printing

Any Apple®-compatible printer can be connected and used to print data from the following windows:

- + Cue Sheet
- + Console Log
- + Color Palette Data\*
- + Patch
- + Macros\*
- + Board Cue Sheet\*
- + Preset Data\*
- + Beam Palette Data\*
- + 3D Location

\* Allows extra print setup options. See below.

### Important Notes

- + In order to compact the information, the software will reduce all text font sizes to 7 point.
- + The Plan View will be reduced so that it always prints on a single page.

### Print Window

The Print window is a standard Mac interface which allows you to configure the printing options. The console allows four extra options when "Vx76" is selected from the bottom popup menu: Summary, Current, All, and From. (Refer to Print window graphic on next page.)

#### Summary -

Would print a list of all Macros in order, but no Step data would be included.

#### All -

Would print the Macro number and all Step data for every Macro (one per page).

#### From -

Would print all data for the specified range.

#### Current -

Would print the Step data for the currently selected Macro.

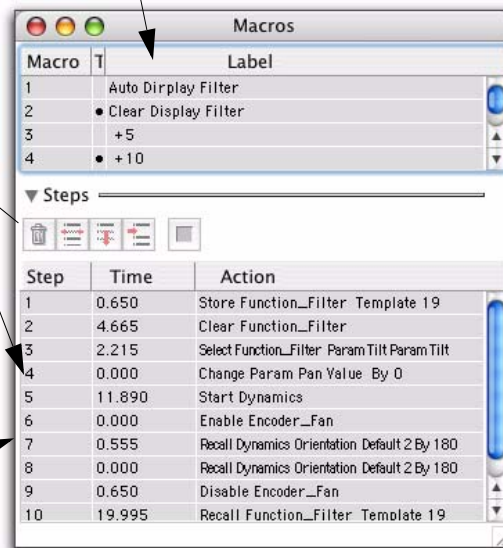

**To print:**

- Step 1. Ensure that window you wish to print data from is open and currently active.
- Step 2. At **File** menu, select **Print...**
- Step 3. At Print window, use pop-up menu to select "Vx76" in order to bring up Vx76 options.
- Step 4. If printing from a special Vx76 window, select which data you wish to print (see previous page).
- Step 5. Click **Print**.

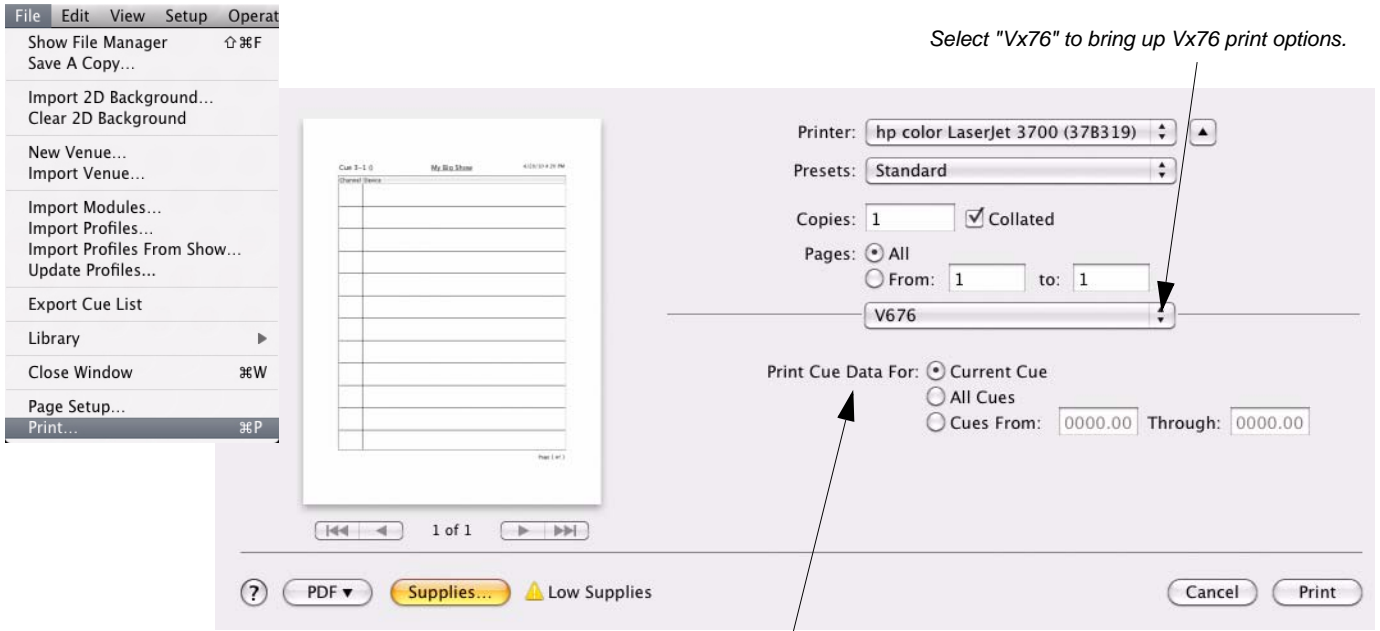

Special Vx76 window options. These are available for specific windows (refer to previous page).

# UPDATING PROFILES

## Overview

As mentioned in the patch instructions covered in Chapter 3, the console utilizes a resource called a *profile* to properly map control of fixtures. The profiles are accessed in the Luminaire Patch windows. (Refer to "Patch" on page 26.)

The Profiles are stored in a Vx76 system folder which is accessed each time a new show file is opened. It is possible to import new Profiles and update older show files with them if desired. When a new show file is opened, it will automatically contain all Profiles currently resident in the console's "Profiles" folder. Profiles may also be deleted as long as they are not currently being used in the patch.

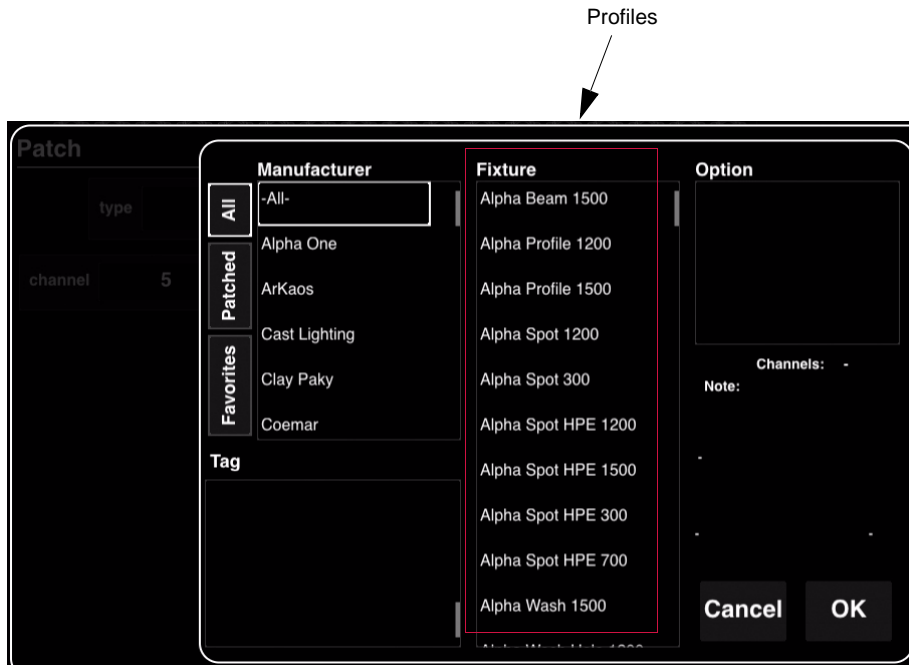



## Importing Profiles

Before Profiles will be available to your show files, they must be loaded into the console's Profile folder.

### To import profiles from an external storage device:

- Step 1. Connect external storage device containing new Profile(s) to console.
- Step 2. At **File** menu, select **Import Profiles...** Load Profiles window will open.
- Step 3. Locate Profiles on your storage device, select, and click **Open**. The Profile(s) will be copied to the console Profile folder.

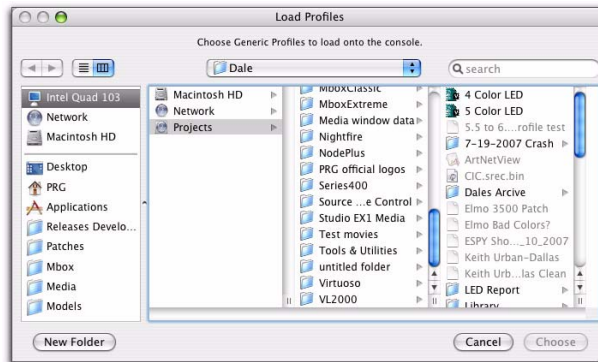
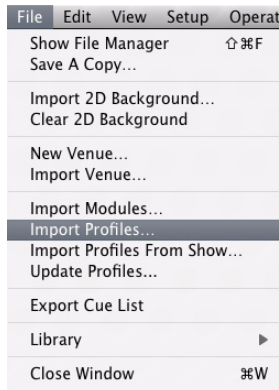

### To import profile from a show file:

- Step 1. At **File** menu, select **Import Profiles from Show**. Import Profiles window will open.
- Step 2. Click on desired show file. Locate Profile at right, select, and click **OK**. The Profile will be copied to the console's Profile folder.

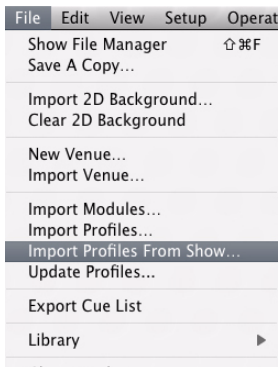

## Updating Profiles

In order to protect existing show files, the console does not automatically update them with any newly imported profiles when using the Import Profiles feature (see previous page). If you desire to update an existing show file with a new profile(s), this can be done using the Update Profiles function.

### To update profiles:

- Step 1. At **File** menu, select **Update Profiles**.
- Step 2. Update Profiles window will open and all profiles in the open show file will be compared to the latest profiles in the console's Profiles folder. If newer profile versions exist, these will be noted in the window.
- Step 3. Check boxes of any fixtures requiring an update and click **Update**.

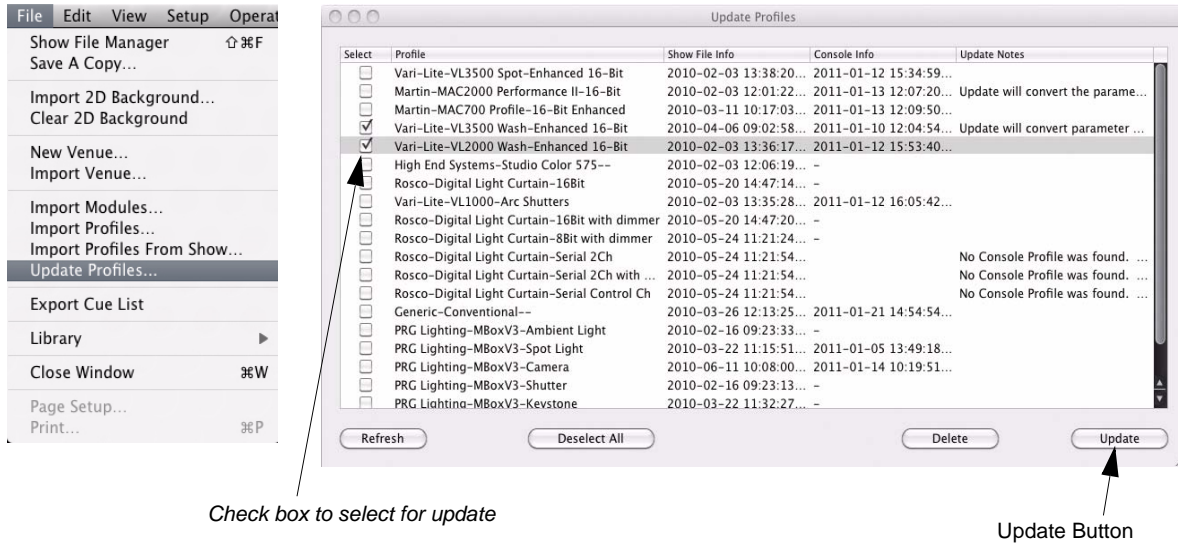

- Step 4. A confirmation dialog will appear. Click **Update** to continue.

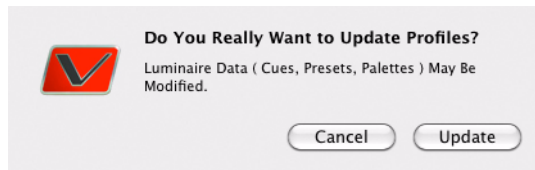

**Note:** To ensure that new profiles are properly installed, reset Nodes after profiles are updated.

## Deleting Profiles

The Profile Delete action can be applied to any profiles that are not currently being used in the patch.

### To delete a profile:

- Step 1. If required, unpatch any profile(s) you wish to delete.
- Step 2. At **File** menu, select **Update Profiles**.
- Step 3. Update Profiles window will open and all profiles in the open show file will be listed.
- Step 4. Check boxes of any fixture profiles you wish to delete and click **Delete**.

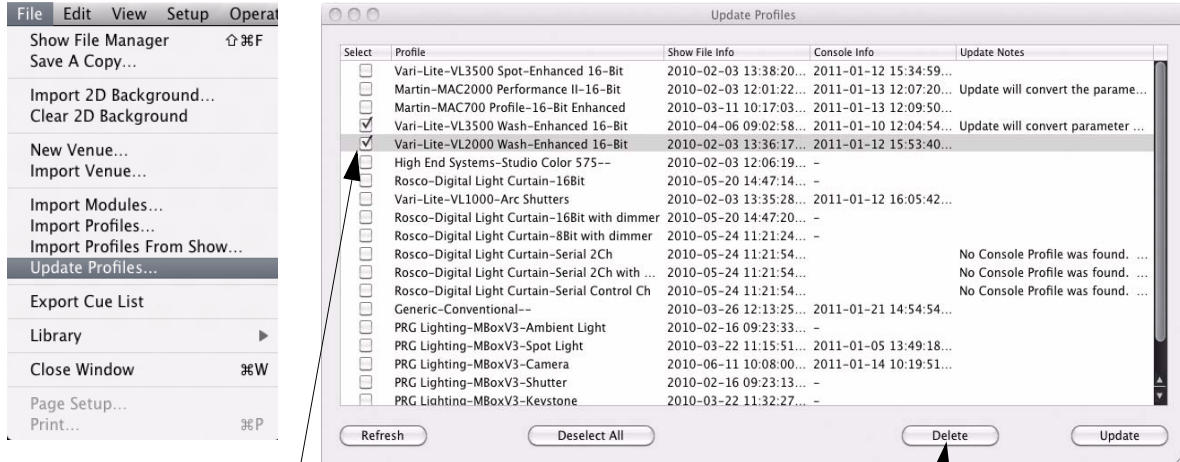

Check box to select for delete

Delete Button

# ON-LINE DIAGNOSTICS

## DMX512 Channel Tests

The DMX Diagnostics available in the DMX Setup window can be used to troubleshoot DMX patch problems. The diagnostic function allows you to send values directly to a specific DMX512 channel, bypassing all other console controls.

### Perform DMX Diagnostics:

- Step 1. At **Patch** or **Setup** menu, select **DMX Setup**. DMX Setup window will open.
- Step 2. To see channel assignment for a DMX universe, use cursor to select universe (A thru Z). Channel assignments associated with that universe will appear in DMX Channel Assignment grid.
- Step 3. To test a specific channel, at DMX Diagnostics section of window, enter channel number in **Channel** field and a value (for example, 100) in **Value** field. Click **Send** to send value directly to channel. Watch for appropriate response in fixture.
- Step 4. To step through channels, enter starting channel in **Channel** field and a value. Click **Dimmer Check** and verify response in fixture. Click **Dimmer Check** again to check next channel (channel number in **Channel** field will increment by one each time).
- Step 5. Click **Clear Diagnostics** to set all channels back to 0 value.

Setup	Operation	Data
Settings		
Ethernet		
Pairing		
System Config	⌘K	
Calibrate Screen		
Legacy Media Setup		
Media Server Setup		
Log	⌘L	
Plan View	⌘B	
Patch	⌘T	
3D Location		
DMX Setup		

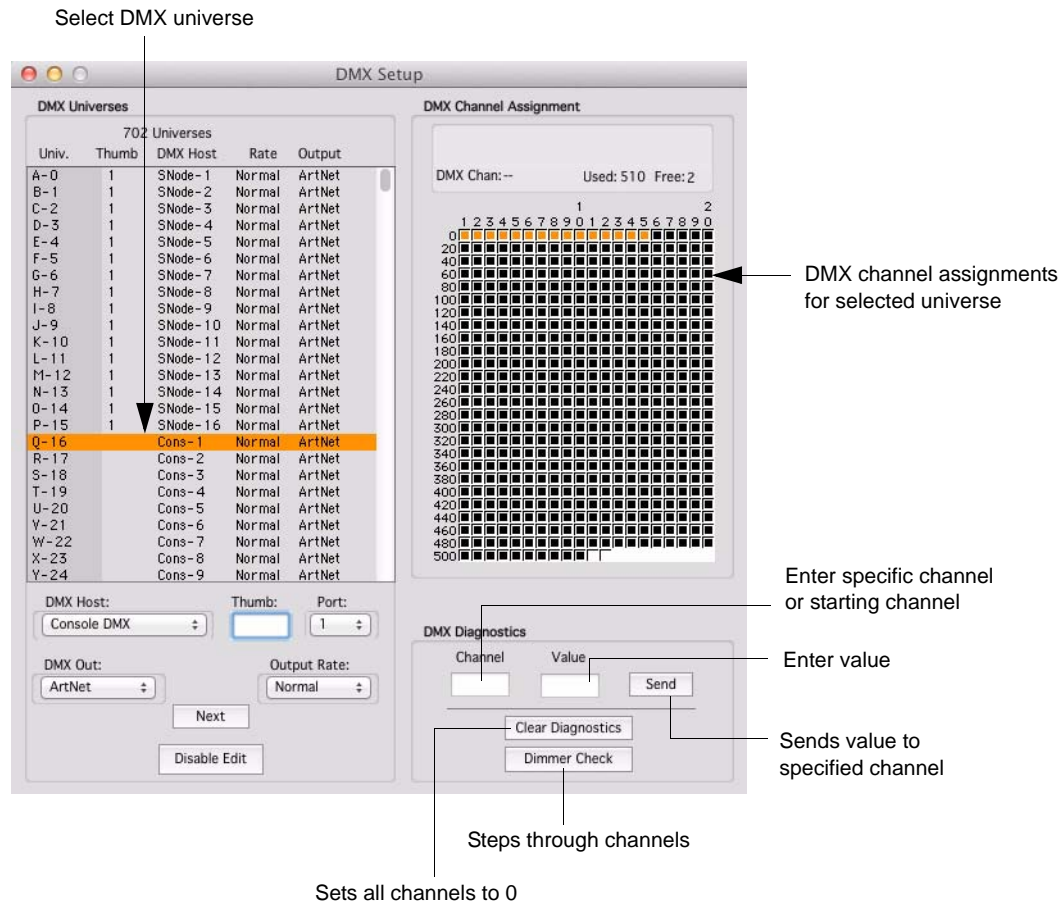

## Dimmer Check Commands

Dimmer Check commands are available on the command-line.



The command syntax is:

- + [Dimmer] universe/channel [At] value [Enter] - Set dimmer at universe/channel to value
- + [Dimmer] [+] - advance to next dimmer
- + [Dimmer] [-] - return to previous dimmer
- + [Dimmer] [Dimmer] - exit dimmer check

When dimmer check is active, the [Dimmer] key on the keypad will blink.

## Clear Status Errors

All error messages can be cleared using the Clear Status Errors command.

**To clear all error messages:**

- + At Special menu, select Clear Status Errors.

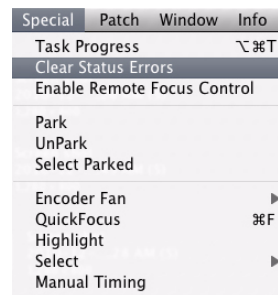



## Notes



**16.**

## **CONTROL BY EXTERNAL DEVICES**

This chapter provides instructions for controlling shows by use of an external MIDI/SMPTE or switch closure trigger device.

- + CONCEPTS
- + MIDI NOTES
- + MIDI/SMPTE TIMECODE
- + MIDI SHOW CONTROL



## CONCEPTS

---

### About MIDI/SMPTE

The console is able to accept two forms of external control:

- + MIDI Notes
- + Timecode (includes both MIDI and SMPTE)

MIDI (Musical Instrument Digital Interface) is a communication protocol that allows electronic musical instruments to interact with each other. Much in the same way that two computers communicate via modems, two electronic instruments can communicate via MIDI. At its most basic structure, MIDI information tells a synthesizer when to start and stop playing a specific note. Since the basis for MIDI communication is the byte, MIDI can also be used as an interface between musical instruments and computers, or in this case a computer-based lighting console. In the same way that MIDI can command a note to start or stop, console functions such as board cue execution can be initiated by a connected MIDI-compatible device. MIDI Notes are mapped console macros while MIDI timecode is recorded as a script.

SMPTE timecode is a communication protocol standard set forth by the Society of Motion Picture and Television Engineers for handling of audio which is associated with motion images. This is essentially the same as MIDI timecode except that it is analog while MIDI timecode is digital. However, once either of these signals enters the console they are stored as digital timecode scripts.

---

**Note:** Only one form of timecode - either MIDI or SMPTE - can be input at one time.

---

### Input Options

#### MIDI In/Thru/Out

Standard MIDI In, Thru, and Out connectors are provided at the console's rear panel for support of any standard MIDI input device.

The associated MIDI LEDs will light when MIDI data is traveling through the port, however, the LED merely indicates the presence of MIDI traffic, *not* that the traffic is necessarily *valid* MIDI traffic.

---

**Note:** MIDI Out will not output MIDI timecode.

---

#### SMPTE Input

A standard female XLR connector is provided at the console's rear panel for input of SMPTE timecode. The input is balanced differential with a 10k ohm input impedance. The XLR connector is wired as follows:

Pin	Wire
1	Ground
2	In +
3	In -

---

**Note:** When connecting a single-ended SMPTE source (such as RCA or 1/4" phone jack), the "hot" lead is connected to XLR Pin 2 and the "ground" is connected to pins 1 and 3. Pins 1 and 3 must be connected together.

---

The associated SMPTE green LED will be *lit* when valid SMPTE data is being received. The LED will *flash* when either the SMPTE data is not valid or the console cannot lock in on the signal.



### Switch Closure Trigger Input

The switch closure trigger port is wired to the Board Control [Go] button. Closing the switch by any compatible device is the equivalent of pressing this button. The triggering device can be any device that will supply the "short," such as a hand-held switch, a relay, a footswitch, etc.

The switch closure trigger port will accept a 2-conductor mini mono phone plug which can be purchased from PRG or other electronics outlets:

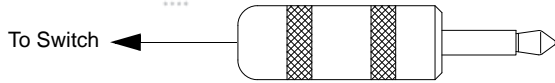

PRG Part No.	Accessory
52.6616.0780	MINI PHONE .141" MONO SHIELDED 2-COND SOLDER PLUG

Manufacturer	Part No.	Accessory
Switchcraft	780	MINI PHONE .141" MONO SHIELDED 2-COND SOLDER PLUG
Digi-Key	SC1057-ND	MINI PHONE .141" MONO SHIELDED 2-COND SOLDER PLUG

## MIDI NOTES

### Note Mapping

The console accepts MIDI note messages. Each MIDI note is mapped to a single macro for the first 127 macros. When the console receives the note, it will execute the corresponding macro.

**Table 16-1: MIDI Note Mapping**

MIDI Note	Macro #	MIDI Note	Macro #	MIDI Note	Macro #	MIDI Note	Macro #
C#-2	1	A0	33	F3	65	C#6	97
D-2	2	Bb0	34	F#3	66	D6	98
Eb-2	3	B0	35	G3	67	Eb6	99
E-2	4	C1	36	G#3	68	E6	100
F-2	5	C#1	37	A3	69	F6	101
F#-2	6	D1	38	Bb3	70	F#6	102
G-2	7	Eb1	39	B3	71	G6	103
G#-2	8	E1	40	C4	72	G#6	104
A-2	9	F1	41	C#4	73	A7	105
Bb-2	10	F#1	42	D4	74	Bb7	106
B-2	11	G1	43	Eb4	75	B7	107
C-1	12	G#1	44	E4	76	C7	108
C#-1	13	A1	45	F4	77	C#7	109
D-1	14	Bb1	46	F#4	78	D7	110
Eb-1	15	B1	47	G4	79	Eb7	111
E-1	16	C2	48	G#4	80	E7	112
F-1	17	C#2	49	A4	81	F7	113
F#-1	18	D2	50	Bb4	82	F#7	114
G-1	19	Eb2	51	B4	83	G7	115
G#-1	20	E2	52	C5	84	G#7	116
A-1	21	F2	53	C#5	85	A8	117
Bb-1	22	F#2	54	D5	86	Bb8	118
B-1	23	G2	55	Eb5	87	B8	119
C0	24	G#2	56	E5	88	C8	120
C#0	25	A2	57	F5	89	C#8	121
D0	26	Bb2	58	F#5	90	D8	122
Eb0	27	B2	59	G5	91	Eb8	123
E0	28	C3	60	G#5	92	E8	124
F0	29	C#3	61	A5	93	F8	125
F#0	30	D3	62	Bb5	94	F#8	126
G0	31	Eb3	63	B5	95	G8	127
G#0	32	E3	64	C6	96		

# MIDI/SMPTE TIMECODE

## Overview

The console will also accept MIDI/SMPTE timecode messages, which can be generated internally or from an external source. The messages generated by the internal timecode generator can be run independently or in sync with an external timecode. If the external timecode source drops out, the internally synchronized timecode allows the MIDI operation to continue. When the internal clock is selected, any external timecode will be ignored.

**Note:** Only one form of timecode - either MIDI or SMPTE - can be input at one time. MIDI Out will not output MIDI timecode.

Timecode can be programmed and played back using the Timecode window. During a record operation, the console will map all appropriate front panel actions to the registered timecode as those events take place. Unless specified otherwise, the internal clock will begin counting at 00:00:00:00.

Timecode has four fields, 00:00:00:00 (or AA:BB:CC:DD):

- + AA - hours (00-24)
- + BB = minutes (00 through 59)
- + CC = seconds (00 through 59)
- + DD - frames (00 through 29)

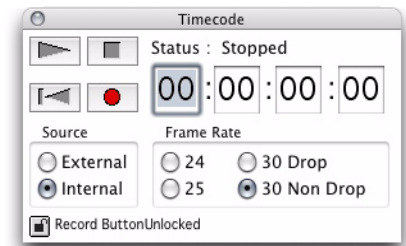

Timecode will also be displayed in the central touchscreen on the front panel:

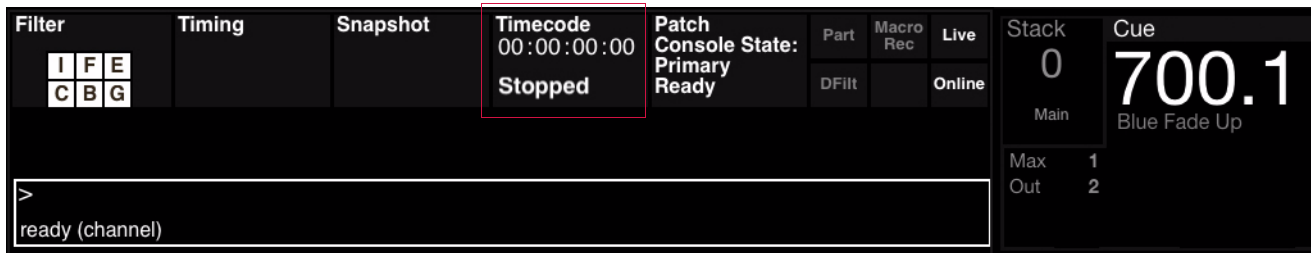

## Synchronizing Protocol

To prevent unexpected interruptions in the MIDI execution of events, a synchronizing protocol is built into the system. This feature can be turned off and on using the Timecode Autoswitch checkbox at the Settings window (refer to "Settings Window" on page 306). During normal operations, the system will wait for each timecode frame before performing the required calculations for each time period. If the incoming timecode arrives approximately on time, and the frame number agrees with the expected time from the system internal clock, the system remains synchronized with the external timecode. If the system begins receiving frames which are outside of the above timing tolerance, the following occurs:

- + If the Timecode Autoswitch is enabled and the system is synchronized awaiting the next frame, and the expected frame is not received within 2 frames, the board will begin running on its internal time clock.
- + If the Timecode Autoswitch is enabled, the system will continue executing events in the normal sequence using its internal time clock, until the system can resync. At that point, the external time clock will take over again and the internal clock will sync to those values.
- + If the Timecode Autoswitch is disabled, the system will stop executing events until timecode is resynced. After resyncing, execution of events will resume.

## Recording

Timecode is recorded using the Timecode window. The timecode and corresponding event steps are stored in a Timecode Script which can be viewed and edited using the Timecode Scripts window (refer to next page). Unless a different script number is selected in the window, the script will be stored as Number 1 by default. To record timecode into a script other than 1, select its number at the Timecode Scripts window.

### Record Timecode:

- Step 1. At **Operation** menu, select **Time Code**. Timecode window will open.
- Step 2. Select **External** or **Internal**.
- Step 3. Select a frame rate.
- Step 4. Click record button to begin timed recording. Clock will start counting.
- Step 5. Execute cues.
- Step 6. Click stop button.

Operation	Data	Special
Cue Sheet		
Board Cue Sheet		
Plan View		⌘B
3D Graphic		⌘C
Luminaire Status		⌘S
Tracking Changes		⌘S
Intensity		⌘I
Timecode		

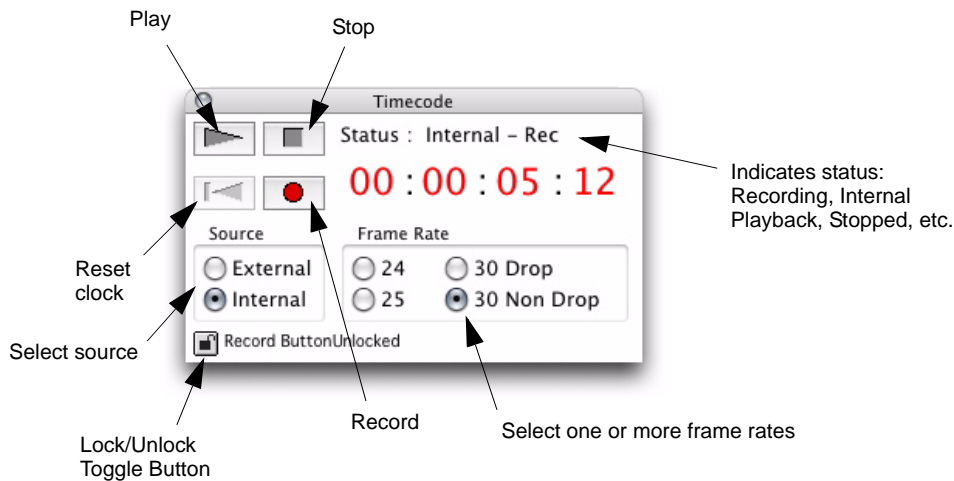

## Timecode Scripts Window

The content of timecode scripts can be viewed and edited in the Timecode Scripts window. The Delete, Replace, Punch In, and Insert features allow editing so that an entire script does not have to be re-recorded in order to make a change. The Time column may also be edited.

To allow creation of multiple scripts, only the selected script will be run.

Any action may change the times of all cues...

- + If a step is deleted, all the following cue times will change.
- + If a step is added, all the following cue times will change.
- + If the [Record] button is pressed while timecode is running, all the times will change (all steps may be deleted).
- + It is best to edit a time within the time range that it already contains.
- + Timecode will only be visible if the [Play] or [Record] buttons are pressed. If the signal is expected from an external source then 'Wait' will be displayed.
- + To insert a step, select a step click "insert" icon and press a single action to be added. To save action, use [Update] [Macro] [Enter] sequence.
- + The Punch In feature bases the new steps/events on the previous timecode and does not record based on external timecode. Therefore, it may be necessary to edit the times manually once the new section is added.

- + The Timecode Scripts window calculates timecode displayed for steps based on frame rate selected in the Timecode window. When the frame rate is changed in the Timecode window, the Timecode Scripts window will recalculate values according to the frame rate selected.
- + Multiple playback scripts are possible. Scripts selected in Timecode Scripts window are enabled for playback.
- + In the Timecode Scripts window individual hour/minute/second/frame times on a step can be edited without affecting any other step times in the script.

**Note:** A timecode script can contain a maximum of 200 console events.

### Using window:

- + To open, at **Data** menu, select **Timecode Scripts**.
- + Click on Steps drop-down arrow to view content of steps.
- + Edit as necessary.

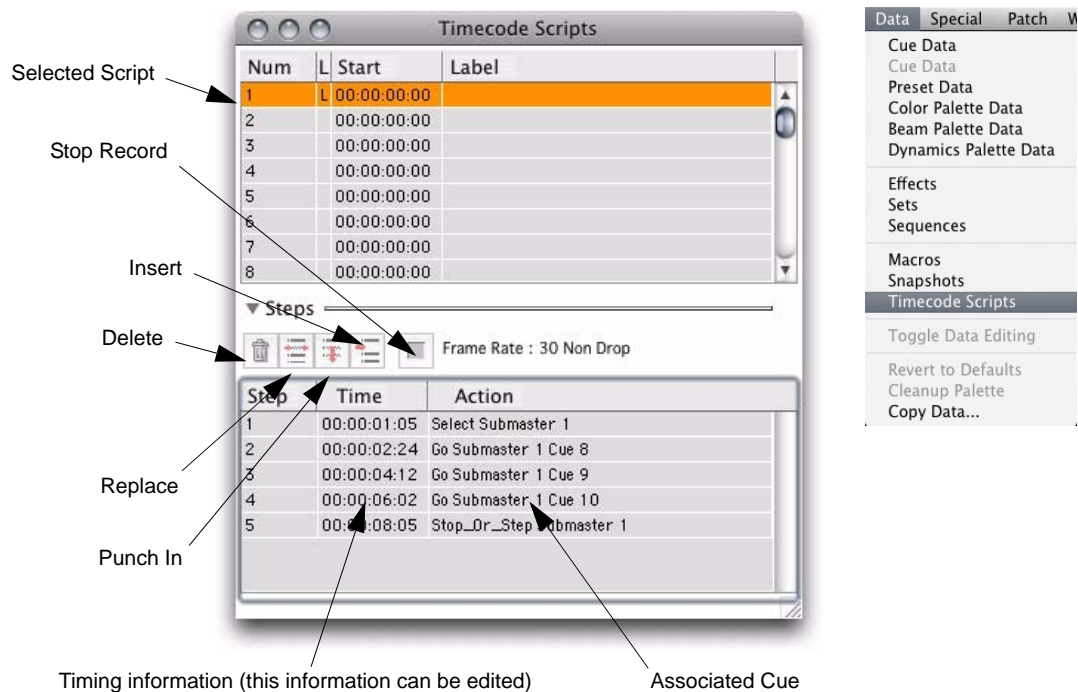

### Delete a step:

- Step 1. Using trackpad, select step(s) to be deleted.
- Step 2. Click on "trash can" icon. Step(s) will be removed.

### Replace a step:

- Step 1. Using trackpad, select step to be replaced.
- Step 2. Click "replace" icon.
- Step 3. At front panel, perform replacement action. (The first action taken will replace the selected step and editing will end.)

### Replace all steps from Step X on (through remainder of script):

- Step 1. Using trackpad, select last "good" step. (Steps after this selection will be replaced.)
- Step 2. Click "punch in" icon.
- Step 3. At front panel, perform new series of actions.
- Step 4. Click "stop record" icon.

### Insert new step(s):

- Step 1. Using trackpad, select step prior to where you wish to insert new step.
- Step 2. Click "insert" icon.
- Step 3. At front panel, perform new action(s).
- Step 4. Click "stop record" icon.

### To select multiple scripts for playback:

- Step 1. Using trackpad, select line of script for playback.
- Step 2. Click in the "L" (Link) column to place a bullet next to each script to be played.

### To edit timecode:

- Step 1. Using trackpad, select step.
- Step 2. At keyboard, press [return].
- Step 3. Enter timecode, from available range in window.

### To move a range:

- Step 1. Using trackpad, select range to be moved.
- Step 2. Edit first frame.

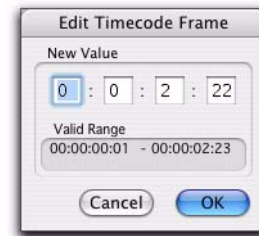

---

**Note:** A shortcut is available for editing timecodes. Highlight the time segment (Hour, minute, second, or frame) to be edited, make changes, and press [return].

---

# MIDI SHOW CONTROL

## Overview

The console can utilize MIDI Show Control (MSC) commands for more advanced external MIDI control. This section covers commands as they relate to Vx76 functions. For more information on MIDI and MSC, consult the following document available from MIDI Manufacturers Association (MMA):

- + The Complete MIDI 1.0 Detailed Specification  
Midi Manufacturers Association  
P.O. Box 3173  
La Habra, CA 90632-3173  
www.midi.org

The console has two options that must be defined before using MSC:

- + The MIDI ID is the device ID of the external device. This value can be defined as anything from 0-126. The system will accept an incoming value of 127 for an "All Call." The MIDI ID default is zero. The MIDI ID of the console must match the external device ID at the MIDI show controller.
- + The "Go #" Action selection, allows you to define if the "Go #" Action will take place for a Submaster or for a Board Cue.

### To configure MIDI show control input:

- Step 1. Select **Settings** from the **Setup** menu.
- Step 2. Click Midi tab.
- Step 3. Select MIDI input device/port.
- Step 4. At Show Control box, input MIDI ID (0-126). Refer to external controller.
- Step 5. Select Sub 1 or Board Cue from the "Go #" Action.

Setup	Operation	Data
Settings		
Ethernet		
Pairing		
System Config		⌘K
Calibrate Screen		
Legacy Media Setup		
Media Server Setup		

Select MIDI Output Device/Port

When using MIDI Notes feature, these buttons select which MIDI channel it will "listen" to (1-16).

Show Control Settings

The screenshot shows the 'Settings' window with the 'Midi' tab selected. The 'MIDI Input' section includes a dropdown menu for 'No Input', a 'MIDI ID (0-126)' field set to 0, and a 'MIDI Channel' grid with buttons 1-16. The 'Go #' Action section has radio buttons for 'Sub 1' and 'Board Cue' (selected). The 'MIDI Output' section includes a dropdown menu for 'No Output', a 'MIDI ID (0-126)' field set to 0, and a 'Format (0-127)' field set to 0. Below this are radio buttons for 'Off', 'Board Control Only', 'Submaster 1 Only', and 'All Submasters'. An 'Options' section has radio buttons for 'Go Only' (selected), 'Go Cue #', and 'Go Cue # Sub #'.

## Variables

The cue number, *Q\_Number*, typically represents actual Vx76 cue number, board cue number or other items that can be numbered such as effects, snapshots, macros, etc.

The cue list, *Q\_List*, represents the submaster number. Zero (0) will be used for board cue playback, 1 through 30 for submasters, and 256 will specifically represent "no submaster" for recall of items other than cues if *Q\_List* cannot remain blank.

The cue path, *Q\_Path*, represents the type of data. The default type will be Cue if no *Q\_Path* is given. They are defined as shown at right.

Q_Path	Data Type
0	Cue
1	Board Cue
2	Effect
3	Set
4	Sequence
5	Macro
6	Snapshot
7	Preset
8	Color
9	Beam
10	PRG Color
11	Group

## Commands

MSC commands are interpreted by the console based on the number, list, and path fields in the cue data.

Command	Description	Data Format
Go	Used for board cue go, submaster go, submaster auto-load, and for recall of any type of Vx76 item.	Q_Number:Q_List:Q_Path
Stop	Will generate either a board cue stop/back or a submaster stop even based on <i>Q_List</i> . (0-30)	--:Q_List:--
Resume	Will generate a submaster run event based on <i>Q_List</i> . ( <i>Q_List=0</i> is NOT valid.) (1-30)	--:Q_List:--
Load	Will generate either a board cue select or a submaster load event based on the <i>Q_List</i> . The Q_Number and Q_Path define the item number and type of item to load.	Q_Number:Q_List:Q_Path (Path can ONLY be empty, 0, or 2)
Set	Used to set fader and grandmaster positions. Control numbers 1-30 correspond to submaster faders, and control numbers 0-510 to the grandmaster. The control values will be the fader position (0-255). The time value is not used.	Special
Fire	Used to recall macros 1-127. Use the <b>Go</b> command to recall other macros.	Special
All Off	Generates a blackout-on event.	None
Restore	Generates a blackout-off event.	None
Reset	Clears all 30 submasters.	None
Go Off	Deselects submaster ( <i>Q_List</i> = 1-30).	--:Q_List:--
Open Cue List	Selects submaster ( <i>Q_List</i> = 1-30).	--:Q_List:--
Close Cue List	Deselects submaster ( <i>Q_List</i> = 1-30).	--:Q_List:--

---

**Note:** If part of the data is left out, the console will default to a particular action depending on the command. Unknown commands will most commonly be reported in the log.

---



## Defined [Go] Actions

The following are actions available with the [Go] command:

- + **Q\_Number = N, Q\_List = 1-30, and Q\_Path = empty or 0:** "submaster {*Q\_Number*} autoload cue N."
- + **Q\_Number = N, Q\_List = 1-30, and Q\_Path = 2:** "autoload of effect N on submaster {*Q\_List*}."
- + **Q\_Number = N, Q\_List = empty or 256, Q\_Path = P (5-11):** "recall of macro, snapshot, preset, color, beam, or group {P}."

The following do not require a *Q\_Path* value, and will ignore any value present.

- + **Q\_Number = empty, Q\_List = empty:** "board cue go next", simulating a simple press of the board cue go button.
- + **Q\_Number = empty, Q\_List = 1-30:** "submaster {*Q\_List*} go next" simulating a press of that submaster's [Go] button.
- + **Q\_Number = N, Q\_List = 0:** "board cue number N go" for the recall of a specific board cue.

---

**Note:** [Go] N:-:- is either a board cue N go or a Sub 1 cue N go, depending on the selection in the Settings window.

---

*Examples of [Go] Command Values:*

Value	Result
-:-:-	Board Cue Go
-:0:-	Board Cue Go
-:1:-	Submaster 1 Go
-:30:-	Submaster 30 Go
-:50:-	Invalid (Bad Submaster #)
1:0:-	Board Cue # 1 Go
12.3:0:-	Board Cue # 12.3 Go
12:1:-	Submaster 1 Autoload Cue # 12
12:1:0	Submaster 1 Autoload Cue # 12
5:26:-	Submaster 26 Autoload Cue # 5
12:1:2	Submaster 1 Autoload Effect # 12
12:-:5	Recall Macro # 12

## MIDI Show Control Output

MIDI show control output can be useful to sync two consoles using MIDI. When enabled, if a cue is recalled in a submaster, the console will output MIDI signals through its MIDI port.

To enable this feature, select any option other than the "Off" in the Settings/MIDI window. If "All Submasters" is selected, MIDI show control output will be active for all submasters. If "Submaster 1 Only" is selected, MIDI show control output will be active for Submaster 1 only.

The MIDI output options are configured using the Settings window.

### To configure MIDI show control output:

- Step 1. Select **Settings** from the **Setup** menu.
- Step 2. Click **Midi** tab.
- Step 3. At MIDI Output, configure device/port and other settings.

Setup	Operation	Data
Settings		
Ethernet		
Pairing		
System Config		#K

Select MIDI Output Device/Port

The console will accept a value of either 1 or 127 for input

MIDI Show Control Output Settings

Go Command Output Options - see "Message Format" below

### MIDI Show Control Message Format

When a Cue Number is sent as data, additional informational fields may or may not be included as part of the complete "Cue Number" description. The option selected in the "Options" area of the MIDI window will determine how much data will be sent with the Show Control "Go" command.

The MIDI show control fields are used as follows:

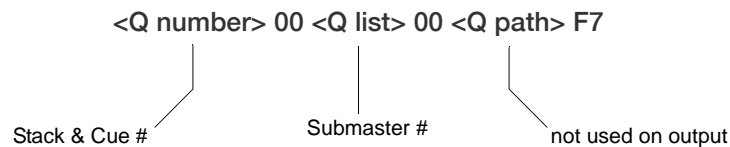

The stack and cue number (<Q number> field) is sent in "n.n.n" format. For example, cue 2-1.5 would be sent as 2.1.5.



**17.**

## **OFF-LINE MODE (VISIONARY)**

This chapter provides instructions for operating the Vx76 software off-line without a console.

+ **VISIONARY OPERATION**

# VISIONARY OPERATION

## Overview

The Vx76 software can be run off-line without the need for a console front panel. This mode, referred to as Visionary, allows show files to be programmed without a console. Any time the software does not detect a front panel, it will automatically launch in the Visionary mode.

**Note:** The Visionary windows are also useful when operating a V276 On Mac, since this console does not include any front panel touchscreens. The V276 HUD was added specifically for this purpose.

## Main Window

In Visionary mode, the panel displays (front panel touchscreens) show up in a special tabbed window. The tabs can be moved and are detachable from the main window (similar to a browser). The windows can be individually resized by dragging the bottom-right corner.

Hotkeys can also be used to switch between tabs. [Cmd-1] through [Cmd-5] correspond to the five tabs.

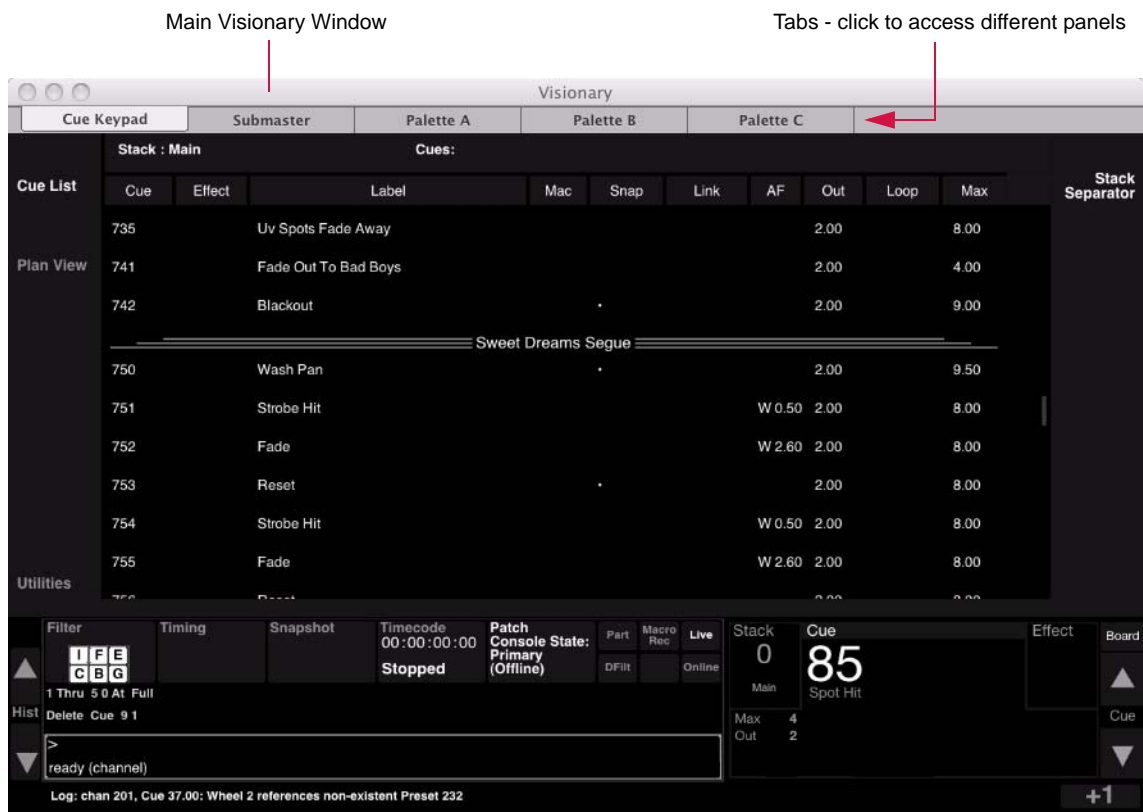

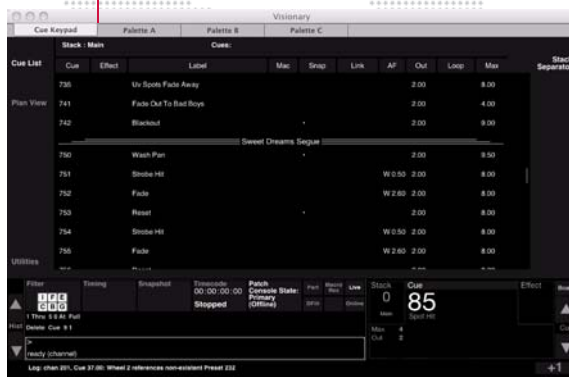

Drag and detach tabs to create stand-alone windows. For example, the Submaster tab:

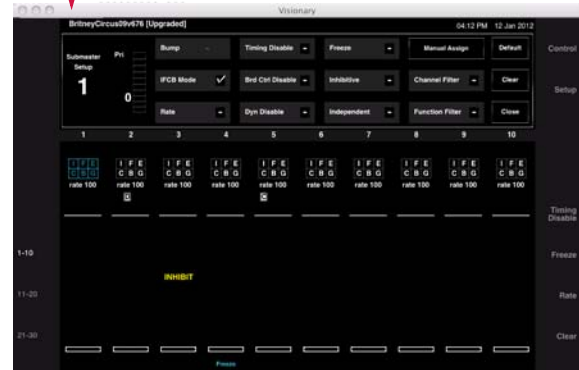

## Heads Up Display (HUD)

To interact with Visionary, four Heads Up Display windows (HUDs) are available:

- + **Command** - provides a command-line keypad, command-line feedback, and control buttons (Store, Label, etc.).
- + **Encoders** - provides encoder control and feedback.
- + **Submasters** - provides submaster buttons and fader levels.

The HUDs can be accessed from the **Operation** menu.

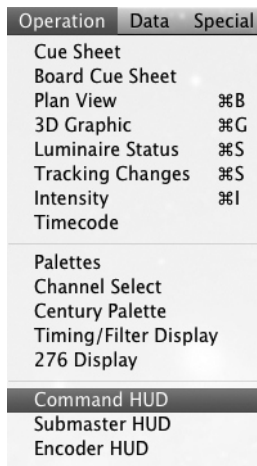

Pin Icon

Resize by dragging from corner

As with the panel windows, the HUD windows can be resized by dragging the bottom-right corner.

There is also an option to "pin" the HUD to keep it on top of other windows. To pin a HUD, click on the pin icon at the top-right corner. When pinning is active, the pin icon will turn from gray to white.

**Note:** The HUD windows are not exclusive to the Visionary mode. They are also available during normal Vx76 console operation via the Operation menu.

## Command HUD Operation

The Command HUD provides a command-line keypad, command-line feedback, and control buttons.

- + Commands are entered into the command-line by clicking the control buttons in the window. When a command requires a subsequent action, the entry will be yellow to indicate that it is waiting for the next action. For example, if [Delete] is pressed, it will require a subsequent entry such as [Cue] before a number can be entered. In this case, Delete will be displayed in yellow as shown below:



- + When an action is presented in yellow, it may be applied to the other panel server tabs. For example, click [Delete], then select a preset in one of the Palette tabs to delete it.

## Encoders HUD Operation

The Encoders HUD provides encoder control and feedback.

- + Use the cursor to turn the virtual encoder knobs.
- + Apply Shift, Control, Fan, and Slow features by clicking the buttons at the top of the window.
- + Switch between encoder types using the drop-down menu at the top of the window.

Current Encoder Type

The diagram illustrates the Encoders HUD interface. It features a top bar with 'Image 1' and a dropdown arrow. Below this are 'Special Buttons' (Shift, Ctrl, Fan, Slow) and a 'Virtual Encoder' knob. The main area displays various encoder types: Edge (with 'soft' and 'hard' buttons and a value of 220), G2 Rot, Gobo 2, G1 Rot, Gobo 1, and Intensity (with 'Shutter' buttons: Full, Mark, Open, Out, Zero, Close). The Intensity section also includes 'Pan' and 'Tilt' controls with 'Flip', 'High light', 'Last', and 'Next' buttons. A 'Values' label points to the numerical display of the Edge encoder. An 'Encoder Selection Menu' is shown as a dropdown list containing: Frame, 3D, Dynamic, Image 1, Image 2, Beam 1, Beam 2, Color 1, Color 2, Effect, and Sequence.

Operation	Data	Special
Cue Sheet		
Board Cue Sheet		
Plan View		⌘B
3D Graphic		⌘G
Luminaire Status		⌘S
Tracking Changes		⌘S
Intensity		⌘I
Timecode		
Palettes		
Channel Select		
Century Palette		
Timing/Filter Display		
276 Display		
Command HUD		
Submaster HUD		
Encoder HUD		
Pan/Tilt Control		⌘;
X/Y Control		⌘'

## Submasters HUD Operation

The Submasters HUD provides submaster buttons and faders.

- + Click the buttons to select and operate the submasters.
- + Use the cursor to move the virtual faders and turn the Rate knob.
- + Switch between the Faders display and Buttons display by clicking the appropriate button at the top of the window.
- + Switch between submaster banks (1-10, 11-20, 21-30) using the drop-down menu at the top of the window.

Current Submasters Bank

Bank Selection Menu

Button Display

Virtual Encoder

Fader Display

Virtual Fader

Operation	Data	Special
Cue Sheet		
Board Cue Sheet		
Plan View		⌘B
3D Graphic		⌘G
Luminaire Status		⌘S
Tracking Changes		⌘S
Intensity		⌘I
Timecode		
Palettes		
Channel Select		
Century Palette		
Timing/Filter Display		
276 Display		
Command HUD		
Submaster HUD		
Encoder HUD		
Pan/Tilt Control		⌘;
X/Y Control		⌘'

The colors of the Submaster HUD match the color coding in the main submaster display:

- + White: Selected
- + Green: Bump
- + Magenta: Effect
- + Teal: IFCB
- + Yellow: Inhibitive
- + Light Blue: Frozen

**Note:** Multiple Submaster HUD windows may be opened.



## V276 Display

The V276 HUD, also available from the **Operation** menu, provides convenient access to the command-line and one palette, along with encoder, cue, stack, filter, timing, effect, and stack data.



- + When an encoder function is selected using the buttons on the V276 console front panel (Color, Beam, Image, Frame, Dynamic, or 3D), its parameters will be displayed in the encoder area.
- + Command-line entries will be displayed in the command-line area.
- + When active, functions such as Online, Primary, Patch, and Macro will be highlighted in yellow.
- + One palette can be displayed in the palette area. The palette selection button can be used to select Preset, Color, Beam, Group, etc.

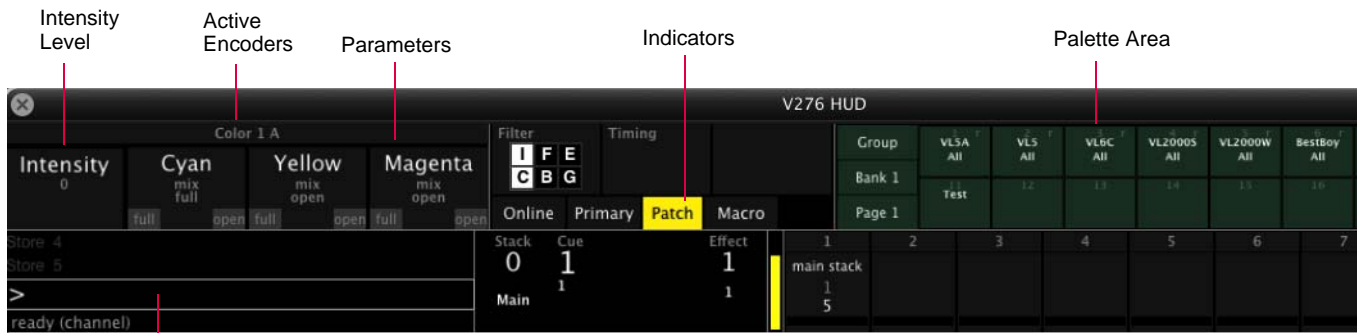

Command-Line

Press to bring up palette selection



- + The Palette buttons, available on the V276 console front panel, can be used in conjunction with the V276 HUD palette. For example, when the V276 HUD window is open, pressing [1] will select palette entry 1 of the selected page/bank.

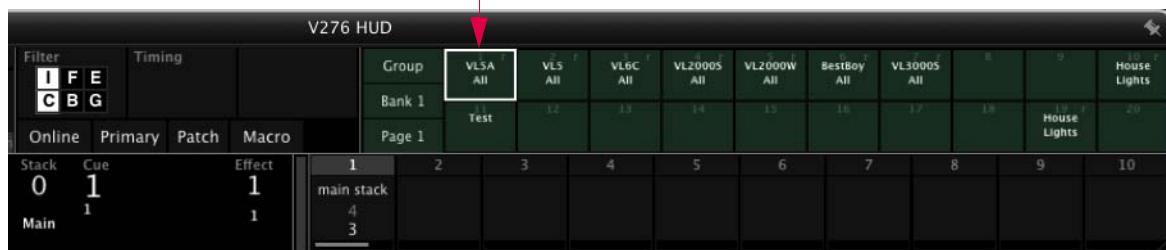
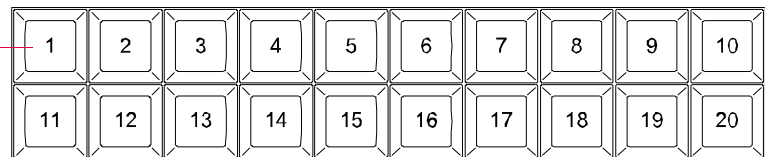

Figure 17-1: V276 Palette Buttons

- + When turning the encoder knobs on the V276 console front panel, the adjusted values will be displayed in the V276 HUD.

Function Encoders (4) -  
Four knobs which control luminaire parameters  
as selected by the Encoder Buttons.

Encoders Buttons -  
Selects a parameter type for  
control by Encoder Knobs.

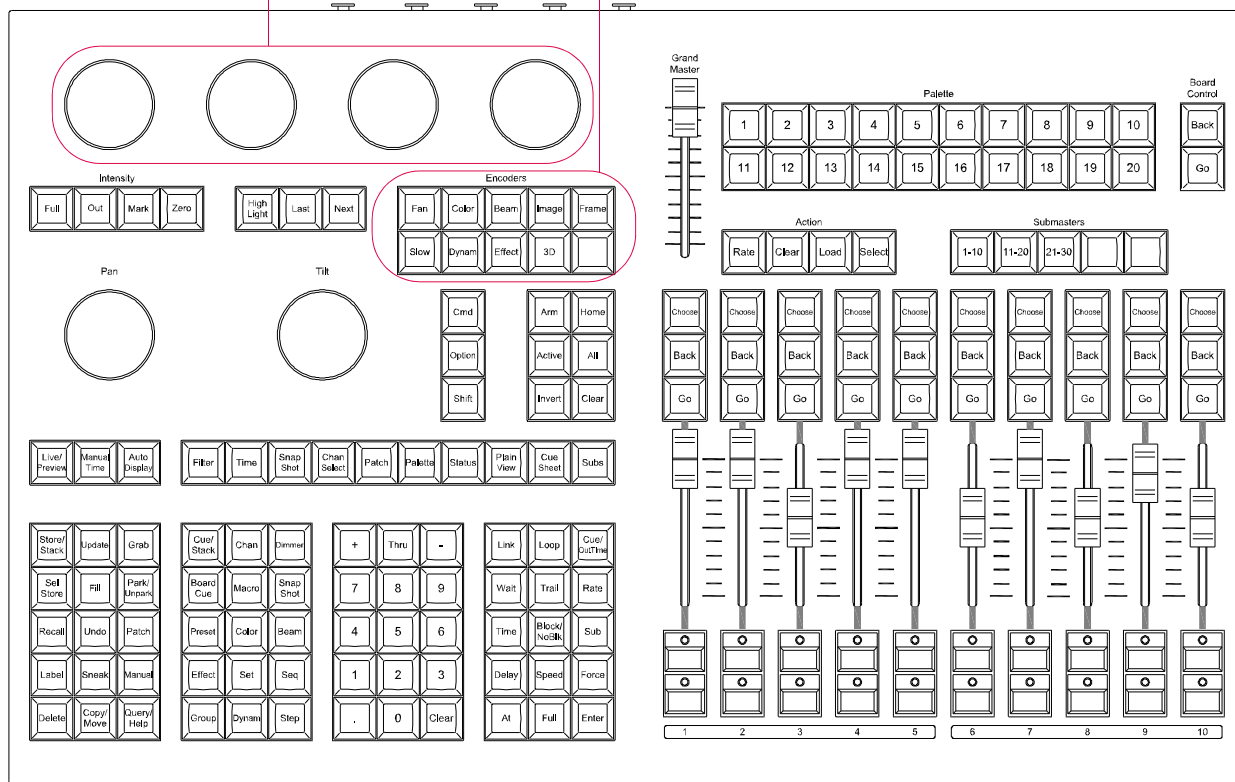
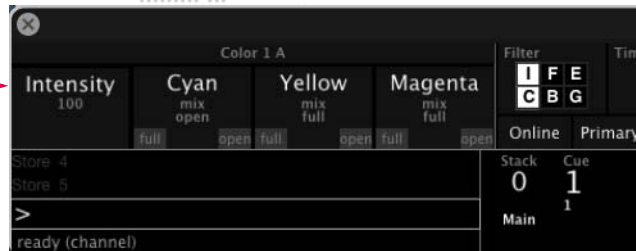

Figure 17-2: V276 Encoder Controls



**A.**

## **REFERENCE**

- + FRONT PANEL AND KEYBOARD SHORTCUTS
- + PRE-PROGRAMMED "CANNED" FEATURES
- + GLOSSARY

## FRONT PANEL AND KEYBOARD SHORTCUTS

---

### Front Panel: Submaster Keypad Combinations

Button Sequence	Action
Rate-Choose *	Toggle rate control for submaster
Freeze-Choose	Toggle freeze state
Chan-Choose	Sets current selection to channel filter for submaster
Clear-Choose	Clear pending and active cues
Clear-Choose	Clear all submaster attributes
Timing Disable-Choose	Toggle timing disable
Label-Choose	Enter label for cue/effect in submaster
Cue-Choose	Set current cue from submaster (D1 mode)
Group-Choose	Select all lights active in submaster
Store-Choose	Store cue in submaster
Update-Choose	Update cue in submaster
Update/Preset-Choose	Update cue in submaster and associated presets
Track-Choose	Track cue in submaster
Fill-Choose	Fill cue in submaster
Sel Store-Choose	Selective Store to cue in submaster
Recall-Choose	Selective Recall from cue in submaster
Plus-Choose	Increment submaster priority
Minus-Choose	Decrement submaster priority
Snapshot-Choose	Creates cue snapshot for the cue in submaster
Clear/SubmasterBank	Deselects the subs in that bank.

\* Refer to "Submaster Choose" on page 280 for more information about the Choose function.

## Front Panel: Palette Keypad Combinations

Button Sequence	Action	Affected Palette(s) *
Store-Select	Store palette item	PCBGMSE
Store/Label-Select	Store item and enter label	PCBGMSE
Update-Select	Update item	P
Label-Select	Label item	PCBGMSE
Group-Select	Select channels currently using item	PCB
Sel Store-Select	Selective store item	PCB
Recall-Select	Selective recall item	P
Delete-Select	Delete item	PCBGMSE
Copy/Move-Select	Initiate and complete copy or move	PCBGMSE
Effect Store-Select	Put item in selected sequence step	PCB
Cue-Sub-0	Releases D1 Lock	

\* P = Preset, C = Color, B = Beam, G = Group, M = Macro, S = Snapshot, E = Effect

## Mac Keyboard Shortcuts

Key	Function
<b>Function Keys</b>	
F1	Store
F2	Selective Store
F3	Update
F4	Track / Fill
F5	Selective Recall
F6	Delete
F7	Intensity Sneak (At)
F8	Copy / Move
ALT + F9	Sneak
ALT + F10	Select
ALT + F11	Time
SHIFT / F1 - F12	Recall snapshots 1-12
<b>Plan View Patch Editing</b>	
arrow keys	nudge fixture movement
CMD /+ A	selects all fixtures in plan view
<b>Palettes</b>	
CTRL + CMD + palette button	stores palette
CTRL + OPTION + palette button	labels palette
<b>3D Window</b>	
left arrow	3D rotate camera left
right arrow	3D rotate camera right
up arrow	3D rotate camera up
down arrow	3D rotate camera down
SHIFT / left arrow	move venue left relative to camera
SHIFT / right arrow	move venue right relative to camera
SHIFT / up arrow	move camera in
SHIFT / down arrow	move camera out
2	move venue down (camera up)
8	move venue up (camera down)
4	move venue left (camera right)
6	move venue right (camera left)
7	move venue forward (camera back)
9	move venue back (camera forward)
<b>Luminaire Status Window - select a parameter column header, then use:</b>	
CTRL / left <i>or</i> down arrow	parameter encoder down
CTRL / right <i>or</i> up arrow	parameter encoder up
(for pan only) SHIFT / CTRL / arrow	changes to tilt
(for tilt only) SHIFT / CTRL arrow	changes to pan
(for all other parameters) SHIFT / CTRL / arrow	dynamic rate encoder

## PRE-PROGRAMMED "CANNED" FEATURES

---

### Canned Dynamics

Canned Dynamics are provided to aid programmers in developing shows more rapidly. These can be found in the Dynamics Palette Bank 1 of the "Untitled" show file. The following is a list of all included Canned Dynamics by number:

No.	Name	Description	Bank	Page
1	Bally Slow	Slow ballyhoo for selected channels	1	1
2	Bally Medium	Medium speed Ballyhoo for selected channels	1	1
3	Bally Fast	Fast Ballyhoo for selected channels	1	1
4	Circle Slow	Slow Circle for selected channels	1	1
5	Circle Fast	Fast Circle for selected channels	1	1
6	Figure 8 Slow	Slow Figure 8 for selected channels	1	1
7	Figure 8 Fast	Fast Figure 8 for selected channels	1	1
8	Roller Slow	Slow Roller Coaster for selected channels	1	1
9	Roller Fast	Fast Roller Coaster for selected channels	1	1
10	Stop All Dynamic	Stops all dynamics for selected channels	1	1
11	Intensity Fade	Intensity fade dynamic	1	1
12	Intensity Bump	Intensity Bump dynamic	1	1
13	Color Wheel Rock	Color Wheel Rock	1	1
14	Color Wheel Roll	Color Wheel Spin	1	1
15	Iris	Beam Iris dynamic	1	1
16	Zoom	Zoom dynamic	1	1
17	Color Mix Fade Slow	Color Mixer slow fade (Mag, Amb, Blue)	1	1
18	Color Mix Fade Fast	Color Mixer fade fast (Mag, Amb, Blue)	1	1
19	Color Mix Bump Slow	Color Mixer slow bump (Mag, Amb, Blue)	1	1
20	Color Mix Bump Fast	Color Mixer fast bump (Mag, Amb, Blue)	1	1

## Canned Macros

Canned Macros are provided to aid programmers in developing shows more rapidly. The Canned Macros, which can be found in the Macros Palette Bank 20 of the "Untitled" show file, were especially designed to work with the Century Palette window when using a touchscreen (optional).

The Canned Macros are organized into logical groups of 20 in order to integrate effectively with the palettes. As with any macros, the Canned Macros can be moved and rearranged to suit any programmer's preferences.

---

**Note:** Some of the Canned Macros use Template 20 as a scratch pad to temporarily store filter settings, so that current filter settings will not be lost. If you plan to use the Canned Macros, it is recommended that you do not use Template 20, as it will not retain its settings.

---

---

**Note:** The palette Hi Lite macros use Color Palette 299 and 300. You will need to store your Hi Lite color into Color Palette 299 and the Background color into Color Palette 300.

---

The following is a list of all included Canned Macros by number:

**Table A-1: Canned Macros**

No.	Name	Macro Description	Bank	Page
1901	Auto Display Filter	Turn on Auto Display Filter	20	1
1902	Load Display Filter	Loads Display Filter	20	1
1903	Clear Display Filter	Clears Display Filters	20	1
1904	Home	Home Luminaires	20	1
1905	Home Inten Full	Home Luminaires and puts intensity at full	20	1
1906	+5	Add 5% to Intensity	20	1
1907	+10	Add 10% to Intensity	20	1
1908	Sub 1 Hi Lite Off	Reselects channels and loads color from sub 1	20	1
1909	Sub 1 Hi Lite Forward	Takes luminaire selection and steps through each channel in ascending order, bumping each channel to white and then back to the cue in sub 1.	20	1
1910	Sub 1 Hi Lite Reverse	Takes luminaire selection and steps through each channel in descending order, bumping each channel to white and then back to the cue in sub 1.	20	1
1911	Mark Back 1 Cue	Takes the current selection and marks the channels in the previous cue	20	1
1912	Mark Back 2 Cues	Takes the current selection and marks the channels two cues back.	20	1
1913	Park	Parks selected channels	20	1
1914	Un-Park	Un-Parks selected channels	20	1
1915	Select Park	Selects parked channels	20	1
1916	-5	Subtract 5% from Intensity	20	1
1917	-10	Subtract 10% from Intensity	20	1
1918	Palette Hi Lite Off	Reselects channels and bumps the color to Color Palette 299.	20	1



**Table A-1: Canned Macros (Continued)**

No.	Name	Macro Description	Bank	Page
1919	Palette Hi Lite Forward	Steps through channel selection in ascending order, bumping the current channel to the Hi lite color (color palette 299) and putting the other channels to the background color (color palette 300)	20	1
1920	Palette Hi Lite Reverse	Steps through channel selection in descending order, bumping the current channel to the Hi lite color (color palette 299) and putting the other channels to the background color (color palette 300)	20	1
1921	Up Time 0 Sec	Sets Up Time for current selection to 0 Seconds	20	2
1922	Up Time 1 Sec	Sets Up Time for current selection to 1 second.	20	2
1923	Up Time 2 Sec	Sets Up Time for current selection to 2 Seconds	20	2
1924	Up Time 3 Sec	Sets Up Time for current selection to 3 Seconds	20	2
1925	Up Time 4 Sec	Sets Up Time for current selection to 4 Seconds	20	2
1926	All Time 0 Sec	Sets time to all parameters for the current selection to 0 seconds.	20	2
1927	All Time 1 Sec	Sets time to all parameters for the current selection to 1 seconds.	20	2
1928	All Time 2 Sec	Sets time to all parameters for the current selection to 2 seconds.	20	2
1929	All Time 3 Sec	Sets time to all parameters for the current selection to 3 seconds.	20	2
1930	All Time 4 Sec	Sets time to all parameters for the current selection to 4 seconds.	20	2
1931	Down Time 0 Sec	Sets Down Time for current selection to 0 Seconds	20	2
1932	Down Time 1 Sec	Sets Down Time for current selection to 1 Seconds	20	2
1933	Down Time 2 Sec	Sets Down Time for current selection to 2 Seconds	20	2
1934	Down Time 3 Sec	Sets Down Time for current selection to 3 Seconds	20	2
1935	Down Time 4 Sec	Sets Down Time for current selection to 4 Seconds	20	2
1936	All Wheels 0 Sec	Sets time to 0 seconds to all wheels for current selection.	20	2
1937	Fade Parameter 1 Sec	Sets time to 1 seconds to all fading parameters such as color mix, intensity, beam, zoom, etc.	20	2
1938	Fade Parameter 2 Sec	Sets time to 2 seconds to all fading parameters such as color mix, intensity, beam, zoom, etc.	20	2
1939	Fade Parameter 3 Sec	Sets time to 3 seconds to all fading parameters such as color mix, intensity, beam, zoom, etc.	20	2
1940	Fade Parameter 4 Sec	Sets time to 4 seconds to all fading parameters such as color mix, intensity, beam, zoom, etc.	20	2
1941	Clear Time Delay	Sets time and delays for all parameters for the current selection to 0 seconds.	20	3
1942	Fanned Time 2 Sec	Sends Fanned time of 0 to 2 seconds to the current selection using the current fan.	20	3

**Table A-1: Canned Macros (Continued)**

No.	Name	Macro Description	Bank	Page
1943	Fanned Time 4 Sec	Sends Fanned time of 0 to 4 seconds to the current selection using the current fan.	20	3
1944	Fanned Time 6 Sec	Sends Fanned time of 0 to 6 seconds to the current selection using the current fan.	20	3
1945	Fanned Delay 2 Sec	Sends Fanned delay of 0 to 2 seconds to the current selection using the current fan.	20	3
1946	Fanned Delay 4 Sec	Sends Fanned delay of 0 to 4 seconds to the current selection using the current fan.	20	3
1947	Fanned Delay 6 Sec	Sends Fanned delay of 0 to 6 seconds to the current selection using the current fan.	20	3
1948	Time Plus 1/2 Sec	Adds 1/2 second of time to the current selection.	20	3
1949	Time Minus 1/2 Sec	Subtracts 1/2 second of time from the current selection.	20	3
1950	Delay Plus 1/2 Sec	Adds 1/2 second of delay to the current selection.	20	3
1951	Cue Sheet	Brings up Cue Sheet Window to its current window state.	20	3
1952	Board Cue Sheet	Brings up Board Cue Sheet Window to its current window state.	20	3
1953	Media Window	Brings up Media Window to its current window state.	20	3
1954	Plan View Window	Brings up Plan View Window to its current window state.	20	3
1955	Luminaire Status Window	Brings up Luminaire Status Window to its current window state.	20	3
1956	Intensity Window	Brings up Intensity Window to its current window state.	20	3
1957	Century Palette	Brings up Century Palette Window to its current window state.	20	3
1958	Select Display	Brings up Select Display Window to its current window state.	20	3
1959	Timing Filter Display	Brings up Timing Filter Display Window to its current window state.	20	3
1960	3d Graphic	Brings up 3D Graphic Window to its current window state.	20	3
1961	Inten Filter	Selects Intensity Filter	20	5
1962	Pan Tilt Filter	Selects Pan and Tilt Filter	20	5
1963	Pan Only Filter	Selects Pan Filter	20	5
1964	Tilt Only Filter	Selects Tilt Filter	20	5
1965	Color Mix Filter	Selects Magenta, Amber, and Blue Filter.	20	5
1966	Color Wheel Filter	Selects Color Wheel 1 Filter	20	5
1967	Beam Filter	Selects Beam 1 Filter	20	5
1968	Strobe Filter	Selects Strobe Filter	20	5

**Table A-1: Canned Macros (Continued)**

No.	Name	Macro Description	Bank	Page
1969	Gobo Filter	Selects Fixed Gobo Filter	20	5
1970	Rotate Gobo Filter	Selects Rotating Gobo Wheel Filter	20	5
1971	Dynamic Rock Around	Selects Rock Around for the current channel and Filter selection.	20	4
1972	Dynamic Rock Above	Selects Rock Above for the current channel and Filter selection.	20	4
1973	Dynamic Rock Below	Selects Rock Below for the current channel and Filter selection.	20	4
1974	Bias Rock Around	Selects Bias Rock Around for the current channel and Filter selection.	20	4
1975	Bias Rock Above	Selects Bias Rock Above for the current channel and Filter selection.	20	4
1976	Bias Rock Below	Selects Bias Rock Below for the current channel and Filter selection.	20	4
1977	Auto Fit	Selects Auto Fit for the current channel and Filter selection.	20	4
1978	Forward	Selects Forward for the current channel and Filter selection.	20	4
1979	Reverse	Selects Reverse for the current channel and Filter selection.	20	4
1980	Stop All Dynamic	Stops all dynamics for currently channel selection.	20	4
1981	Offset 0 Degrees	Sets Offset to 0 Degrees for current channel and filter selection.	20	4
1982	Offset 90 Degrees	Sets Offset to 90 Degrees for current Channel, Fan and Filter selection.	20	4
1983	Offset 120 Degrees	Sets Offset to 120 Degrees for current Channel, Fan and Filter selection.	20	4
1984	Offset 240 Degrees	Sets Offset to 240 Degrees for current Channel, Fan and Filter selection.	20	4
1985	Offset 360 Degrees	Sets Offset to 360 Degrees for current Channel, Fan and Filter selection.	20	4
1986	Sine Wave	Selects Sine Wave for current Channel and filter selection.	20	4
1987	Triangle Wave	Selects Triangle Wave for current Channel and filter selection.	20	4
1988	Sawtooth Wave	Selects Sawtooth Wave for current Channel and filter selection.	20	4
1989	Reverse Sawtooth Wave	Selects Reverse Sawtooth Wave for current Channel and filter selection.	20	4
1990	Square Wave	Selects Square Wave for current Channel and filter selection.	20	4
1991	Bally Hoo Dynamic	Creates Bally Hoo for the current channel selection.	20	5
1992	Circle Wave Dynamic	Creates fanned circle wave for the current selection.	20	5



**Table A-1: Canned Macros (Continued)**

No.	Name	Macro Description	Bank	Page
1993	Figure 8 Wave Dynamic	Creates fanned figure 8 for the current selection.	20	5
1994	Roller Wave Dynamic	Creates fanned Roller Wave for the current selection.	20	5
1995	Tilt Wave Dynamic	Creates fanned tilt wave for the current selection.	20	5
1996	Pan Wave Dynamic	Creates fanned Pan wave for the current selection.	20	5
1997	Intensity Dynamic	Creates fanned Intensity wave for the current selection.	20	5
1998	Multi M-A-B Dynamic	Creates a fanned multi color dynamic using color mix. (Mag, Amb, Blue)	20	5
1999	Solid M-A-B Dynamic	Creates a solid color dynamic using color mix. (Mag, Amb, Blue)	20	5
2000	Stop All Dynamic	Stops all dynamics for currently channel selection.	20	5



## GLOSSARY

---

### Glossary of Terms

#### Active

An intensity value greater than zero (1-100%). When a luminaire is *active*, it will store data for all parameters (including intensity). Also, a selected submaster and its associated cue are considered active.

#### Ad Hoc Group

A group of channels selected "on-the-fly" which has not already been pre-stored (as a group). Ad Hoc channel selection is based on information such as "all channels in a specific preset."

#### Beam

The size, shape, and sharpness of the light image being output by a luminaire. Also, a function of the luminaire related to the above characteristics. In a wash luminaire, beam defines lamp centering position. In a spot luminaire, beam defines the iris size.

#### Beam Palette

Programmed beam attributes which can be applied to selected channels using the Beam Palette or command-line keypad.

#### Blackout

When the console's overall intensity output level is set to zero (0%).

#### Block

Applied to a cue so that when a track/fill operation reaches that cue, the track/fill will be stopped. *Also see* **Track/Fill**.

#### Board Cue

A method for orchestrating the playback of recorded events on submasters. By using a board cue, a number of cues and effects can be loaded and activated in faders simultaneously or with timing delays on a cue basis.

#### Broadcast

Digital data signals transmitted from the control console to the luminaires and interface devices. The signal is received by all luminaires simultaneously and interpreted by each individually.

#### Bump

A submaster mode in which pressing the submaster's [Select] button will instantly "bump" full intensity as provided by the cue and fader position for all channels in the active cue.

#### Channel

A control reference which collects a device's associated thumbwheel address(es) (device, lamp power, etc.) and maps them to a single selectable number. Channels are assigned via the patch setup. (Also referred to as a "Control Channel.")

#### Channel Filter

A submaster mode which allows only the channels selected at the point the channel filter button is deployed to be enabled on that submaster. Taking the submaster out of channel filter mode enables all channels again. The channels to be filtered must be selected each time the channel filter is engaged for a submaster.



## **Color**

The subjective interpretation by the human eye and nervous system of electro-magnetic radiation in the 380 to 760 nm band (visible light). Also, a function of the luminaire specified by color and saturation data, or by filter position data.

Hue is the subjective appreciation of the dominant wavelength of a light source; the attribute of color perception by which different parts of the spectrum are distinguished (red, orange, yellow, green, blue, violet, purple).

Saturation is the subjective appreciation of purity, a relation of the intensity of the dominant wavelength to all other wavelengths (defined by terms such as deep, pale, light, dark).

## **Color Palette**

Programmed colors which can be applied to selected channels using the Color Palette or command-line keypad.

## **Command-Line**

A series of keypad entries for the purpose of manual control of luminaires or for programming cues, effects, presets, etc.

## **Control Channel**

*See Channel.*

## **Copy/Move**

Feature which allows manipulation of preset, cue, sets, and sequences data.

## **Crossfade**

A cue type (as opposed to an effect cue type) that contains end state target data and timing transition data.

Crossfades will replace the data provided by the previous cue in the same fader, or will provide last instructions to all parameter data when played back in another fader, with the exception of intensity data, which is handled in a HTP manner (unless LTP is selected as the intensity default).

## **Cue**

A programmed event that can be played back on any submaster. A cue can be a crossfade or effect. 10,000 cues can be recorded, numbered from .01 to 9999.99.

## **Cue Attribute**

Data which is programmed in association with a given cue number. Cue attributes include labels, out time for luminaires assuming an inactive state in the associated cue, links to other cues, macros, board cues or snapshots, with or without wait/trail times and alternate fader assignments. Rate, link, and loop instructions may also be associated with cues.

## **Cue Sheet**

Provides a sequential listing of cues and board cues along with all assigned attributes. Also, indicates cue status (active or inactive) and is reflective of live mode operations in that it will display the last activated cue.

## **Cue Stack**

*See Stack.*

## **Delay Time**

A countdown time applied to any luminaire parameter time which begins from the moment the associated cue is executed.

## **Direct Mode**

A console mode in which the command-line display tracks the sequence of cues being executed in a submaster. This can be useful when updating or re-storing cues.



## **Douse**

To de-energize a luminaire lamp. (Douse is unrelated to intensity states.)

## **Down Fade Time**

Timing value associated with channel intensity settings. Down Fade time affects the intensity transition in the event the transition is in a downward direction. The Down Fade time has an associated delay time.

## **Dynamic Disable**

A submaster mode which prohibits the replay of dynamic states on that submaster.

## **Dynamic**

A quick method for creating dynamic effects (states of motion) across groups. Controls such as waveform, rate, size, offset direction, and gravity can be used to customize and implement dynamics.

## **Edge**

In a wash luminaire, edge defines the spot or flood range of the diffusion mechanism(s). In a spot luminaire, edge defines the hardness or softness of the beam edge.

## **Effect**

A programmed chase sequence that can be played back on any submaster. An effect consists of programmable sets and sequences. When assigned to a cue number, the effect data is the only data stored with the cue. 500 effects may be programmed, numbered from .01 to 999.99.

## **Effects Index**

Changes orientation of rotating effect.

## **Effects Wheel**

A beam altering mechanism available in some luminaires. Sometimes called a "prism" wheel.

## **Effect Timing**

Timing values applied to an overall effect or its associated steps. Each step in a sequence can be provided with a discrete attack time (fade in), sustain time (hold), decay (fade out) and step time. Each effect can be provided with an overall fade-in time, fade-out time, duration, and decay time.

## **Emergency Cue**

The state a luminaire will assume if communication between the luminaire and the console is disrupted for more than 15 seconds. It is possible to have no emergency cue specified (in which case the luminaire will fade to inactive) or to have a "Remain in State" instruction, in which case the luminaire will take no action. Any cue can be specified as the emergency cue by using the Settings window.

## **Frame**

A luminaire mechanism which allows framing of the light beam. Control for frame is provided by the soft encoders.

## **Filter**

Used to withhold data from a preset or a cue, or to control what is recalled in a submaster or palette. Assignment of filters is a manual attribute. If a cue is recorded with a filter in place, the filter becomes a mask and is a recorded element in that cue. Filters active during preset records will withhold that data from the target preset. Filters are ignored during preset recall and cue/preset update commands. Applied submaster filters take effect on the next cue recall.

## **Filter Mode**

A touchscreen display mode, which provides access to filter states.



## Flip

A function which moves pan 180 degrees about the zero axis and "reflects" tilt about the zero axis.

## Focus

The point to which the light beam is directed. Also, a function of the luminaire related to the direction of the beam as specified by pan and/or tilt data.

## Freeze

A submaster mode which halts cue movement on that submaster.

## Frost

A beam attribute available in some DMX512-controlled luminaires. Control for frost is provided by the soft encoders.

## Function

One of the variable operational parameters of luminaires (intensity, focus, color, beam, gobo, timing and dynamic states).

## Function Filter

A submaster mode which transfers the current filter settings to the selected submaster.

## Gobo

A luminaire mechanism which allows projection of a design or custom image in the light beam.

## Grab

The capability to withhold functions of a channel from playback. When a channel is "grabbed," the current function filter will determine which parameters are affected. These parameters will respond normally to all manual commands, but will not respond to any submaster control.

## Grand Master

Fader which masters the overall intensity output of the console. Its contribution is calculated after input of stored cue values and submaster fader settings.

## Group

A collection of luminaire control channels. Groups may be selected from the Group Select portion of the Channel Select panel or from the command-line keypad. *Also see* **Ordered Group**.

## Group Palette

A function of the palettes which allows channels to be stored and recalled as groups.

## Highlight

A method for identifying a particular fixture or set of fixtures by putting them into a predefined state which distinguishes them from the rest of the system.

## Hue

The subjective appreciation of the dominant wavelength of a light source; the attribute of color perception by which different parts of the spectrum are distinguished (red, orange, yellow, green, blue, violet, purple).

## HTP

Highest Takes Precedence. During intensity conflicts, this setting causes luminaires to assume the intensity value of the selected channel having the highest value.





### **Inactive**

A luminaire state (programmed via the [Out] button) in which no recorded data is provided for that luminaire in a selected cue. When a luminaire is *inactive* (or *out*), it will not store data for any parameter.

### **Independent**

A submaster mode which prohibits the associated submaster's contents from being altered by any other active submaster. Releasing the submaster from its independent state makes the associated channels/parameters available to other control. Those channels will respond to the next available instruction for which it has stored data. The intensity levels for channels on independent submasters are affected by the setting of the Grand Master fader.

### **Indexing**

Changes orientation of rotating gobo.

### **Intensity**

The amount of light emitted by a source, per second in a given direction within a cone of unit solid angle. Also, the function of a luminaire related to the brightness of the beam as projected on a surface, specified by intensity data.

### **Label**

An alpha-numeric identifier which can be stored with elements such as cues, effects, groups, macros, templates, and selects.

### **Link**

A cue attribute which alters the next sequential cue in the Cue Sheet. The automatic activation of the linked cue is dependent on the presence of a wait or trail time. Links can be made to cues, effects, snapshots and macros.

### **Live Editing**

A console mode wherein all actions taken are actually executed by the luminaires, in real time, on stage. *Also see Preview Editing.*

### **Load**

When a cue or effect is moved to a submaster's pending file.

### **Loop**

An attribute that can be added to a cue, indicating the number of times a linked sequence of cues is to execute.

### **Luminaire State**

A luminaire can be in one of four different states in a cue. When the luminaire is *active*, it has recorded data for intensity and all other parameters. When *marked*, it has no intensity data, but does have other parameter data. When the luminaire is *zero*, it has intensity data at 0% but does not have other parameter data (opposite of *marked*). An *inactive* luminaire (out) has no recorded data for any parameter.

### **Macro**

A series of command strings (button presses or display selections) that can be recorded for automated playback, either through manual selection of the associated macro number, or from automated activation through the Cue Sheet.

### **Manual Assign**

A submaster mode which allows a submaster to control the parameters of manually assigned channels, as well as stored events.

### **Manual Control Override**

Manual Control Override allows a manual intensity level to be established for an inactive channel. That level will remain in effect until a channel receives a command from an active, marked or out channel. A channel on manual

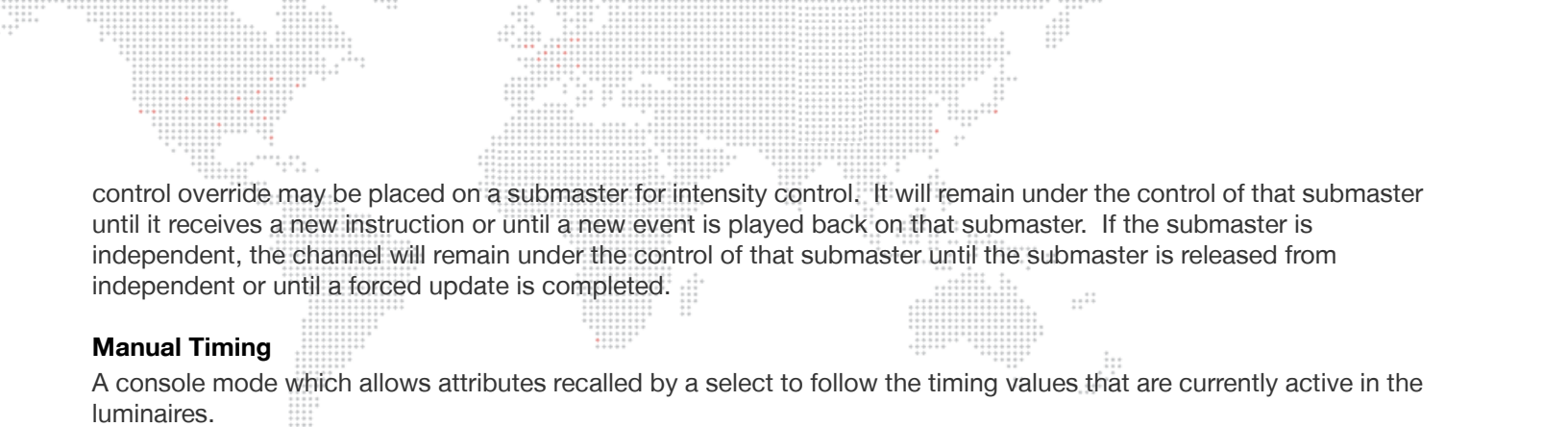

control override may be placed on a submaster for intensity control. It will remain under the control of that submaster until it receives a new instruction or until a new event is played back on that submaster. If the submaster is independent, the channel will remain under the control of that submaster until the submaster is released from independent or until a forced update is completed.

### **Manual Timing**

A console mode which allows attributes recalled by a select to follow the timing values that are currently active in the luminaires.

### **Manual Undo**

Returns an affected channel/parameter to its previous state after a select is deployed or an action is taken on the keypad or with an encoder. Channel selection opens a buffer which snapshots the current setting, making it possible to restore (by subsequent presses of the [Man Undo] button) all actions taken between one channel selection and the next.

### **Marked**

An intensity state of "marked" (0% level). When a luminaire is *marked*, it will store data for all parameters with intensity stored as "marked" (0% level). When a cue is recalled, a *marked* luminaire will move to the stored positions and, if previously active, fade out with the luminaire's intensity down time.

### **Mask**

Prohibits move instructions from affecting those parameters on all luminaires in the cue during cue store actions. Assignment of masks is a stored parameter attribute, which may be applied during live recording, via a Store, Selective Store operation and in preview operations. Masked values are displayed in preview mode and may be lifted via preview editing.

### **Multi-Console Mode**

Used to establish control boundaries when more than one console is being used to control a lighting system. A console can either share channel control with another console or it can have exclusive control. Definition of control interaction is determined by the profiles assigned at the primary console.

### **Null State**

A state which can be used in an effect sequence. The Null action will return the fixtures to their previous state before the effect was started (for example the previous cue recalled by the submaster). The Null action can be used as an effect Background State or as the action for any sequence step.

### **Off-Line**

A feature which allows preprogramming without being connected to a physical system. When in the off-line mode, all menus and windows are accessible just as if the system were online. (The off-line feature does not eliminate the need for a console.)

### **Ordered Group**

A group in which selection order has been stored. Next/Last and Fan will follow original selection order when working with Ordered Groups.

### **Out**

A luminaire state in which no recorded data is provided for that luminaire in a selected cue. When a luminaire is *out*, it will not store any parameter data. When a cue is recalled, an *out* (or *inactive*) luminaire will not change parameter positions, but if previously active, it will fade out with either the cue time or the console's default time.

### **Out Time**

A cue attribute that defines the intensity fade out time of any luminaires which are *active* at the point of cue playback, but which are *inactive* in the cue being played back and are not included in any other active cue. Out Time will also define the intensity fade out time in the event the submaster is de-selected.



### **Page**

A number of selects available in each bank of group, beam, color, preset, macro, dynamic, stack, template, and effect selects.

### **Park**

A luminaire state in which it will not respond to any manual or playback commands, nor will it store into any cues.

### **Palette**

A bank of associated buttons used to store and recall attributes for Beam, Color, Preset, Dynamics, Effects, Snapshots, Macros, and Cue Stacks.

### **Part**

A component of an effect set. Parts are made up of specified channels (luminaire groups) with the limitation that a channel may only appear once within the set.

### **Patch**

The mechanism by which thumbwheel addresses (luminaire and interfaces) are assigned to channel numbers. Any number of conventional thumbwheels may be patched to a single control channel. *Also see* **Channel**.

### **Preset**

A set of programmed parameters which can be applied to selected channels using the Preset Palette or command-line keypad. All luminaire parameter attributes, including timing values, may be stored into a preset. Changes to presets track automatically into any cues in which they were used.

### **Preview Editing**

A console mode wherein all actions taken are stored to the appropriate luminaires, but are not executed on stage. *Also see* **Live Editing**.

### **Primary Console**

This console serves as the main system console. It stores the show file and retains overall submaster control.

### **Prism**

A beam altering mechanism available in some luminaires. Sometimes called an "effects" wheel.

### **Quick-Focus**

QuickFocus allows stepping through a selected preset, one channel at a time, to verify its parameter data. At the conclusion of a QuickFocus operation, all luminaires are brought to the proper position, allowing the preset to be modified if required.

### **Range Editing**

Allows data to be modified across a range of presets and cues. Range editing is provided for modifying parameter attributes, timing information, and cue data. Range editing allows targets to be selected for modification by particular attributes, i.e, channels in a particular state could be selected and told to assume some other state (not necessarily via the same parameter).

### **Rate**

Allows the recorded time/speed attributes for luminaires to be manually adjusted. Rate adjustments (from 0 to 999) may be provided to a board cue, a cue, or effect. Rate adjustments can be added to the cue attributes for later recall. The default setting of 100 is defined as real time. Rates higher than 100 will cause faster playback of events, while rates lower than 100 will cause slower playback of events.

### **Recalibrate**

Returns a luminaire to its default home position based on its profile and re-downloads data.



## Recall

Allows specified parameter data for selected channels to be recalled live from stored preset or cue, as modified by any filter settings.

## Reset

Activates a soft reset as supported by the luminaire profile. (Note that this action does not re-download a luminaire's data.)

## Run

To resume the operation of a stopped effect, or resume the wait/trail countdown of a stopped cue.

## Select

To obtain manual control of a luminaire from the console.

## Selected

A channel or group of channels which will respond to manual control.

## Saturation

The subjective appreciation of purity, a relation of the intensity of the dominant wavelength to all other wavelengths (defined by terms such as deep, pale, light, dark).

## Secondary Console

This console is an additional console hosted by the primary console. It receives show data from the primary and mirrors all submaster operations.

## Selective Store

A special command which is used to modify or add parameter data to a cue, preset, or beam state for specified channels (active or inactive).

## Selective Recall

A special command which is used to recall specific parameter data from specified channels (active or inactive) in a cue, preset, or beam state.

## Sequence

A component of an effect which is made up of a number of steps. The steps specify what action the applied set (groups of lights) are to take in an effect. *Also see Set.*

## Set

A component of an effect which is made up of a number of parts. The parts specify which channels are to be included in an effect.

## Show File

A file containing all programmed cue data. Show files reside on the console's hard drive and can be backed up to an external storage device such as a Flash drive.

## Shutter

A mechanism which controls the douser or strobe action of luminaires capable of this function.

## Snapshot

A stored configuration for a console panel. Snapshots can be recalled either manually or through cues in order to reset any one or all of the front panel controls or displays to the stored configuration.



### **Sneak**

A dual-purpose function which allows manual control values to be staged and then recalled in a specified time. Sneak provides a graphic display of command-line entries that would not normally be visible and also provides a means of creating manual control moves "on-the-fly." For this purpose, values can be assigned to parameters and then recalled at a specified time, luminaire time, or by manually pressing Enter at the touchscreen.

### **Soft Encoder**

One of six soft encoders provided for mapping parameters other than pan, tilt and intensity (which are mapped to hard encoders).

### **Speed**

The rate of change of a luminaire's variable parameters. As opposed to time (e.g. 5 seconds), speed is how fast the parameters will move.

### **Stack, Cue**

Cue Stacks (also known as "multiple cue lists") allow for additional cue lists separate from the main cue list. Each cue stack can have its own set of cue numbers and includes the ability to store submaster attributes such as bump modes, creation of cue based chases, etc.

### **Start**

To energize a luminaire arc lamp (applies to arc-lamp luminaires only).

### **Step**

To advance a halted (stopped) effect to its next step.

### **Step (Effect)**

A component of an effect sequence. Steps specify what action the applied set (groups of lights) are to take in an effect. *Also see* **Sequence**.

### **Store**

To save any intensity value, parameter attribute, group selection, or timing information into a specified target (e.g., cue, palette, preset, etc.).

### **Submaster**

A playback device that can be used to execute cues, board cues, and effects. Cues include luminaire target states (crossfades) and effects.

### **Synchronized**

In handling MIDI timecode from an external source, synchronized is when incoming timecode arrives approximately on time, and the frame number agrees with the expected time from the system's internal clock.

### **Template**

Saved settings for filter, timing, and/or sneak modes.

### **Timing**

Control of the duration of change for a luminaire parameter. Time is defined in minutes and seconds.

### **Timing Disable**

A submaster mode which inhibits timing values on the associated submaster, allowing playback at full speed.

### **Timing Mode**

A touchscreen display mode, which provides a means of defining timing, delay, and speed values for any or all combination of parameters.



### 3D Location

A device's X, Y, and Z coordinates. These three coordinates are based on a point of origin (X=0, Y=0, Z=0) from which every object in the 3D graphic has been located.

### Touchscreen

The touch sensitive screen which allows access to Timing, Filter, and Sneak settings.

### Track/Fill

To force a new parameter setting for selected channels through the cue sheet until a channel block command is encountered or the luminaire parameters affected are set to a different value. A different value may come from absolute values that are different, a preset value that is different or the same value provided by a different preset. Tracking instructions will also be stopped by blocked channels. Track may be used in conjunction with Store, Update and Selective Store. Fill causes the instructions to track backward and forward through the cue sheet.

### Trail Time

A timing attribute which can be applied to a cue, causing the next event to be automatically executed after the trail time has elapsed. The trail time begins counting from the moment the cue has completed. (The next event being either the next sequence cue, a linked cue, or a linked macro.)

### Undo

To reverse the last store or delete action on the console.

### Update

An advanced store/modify function which is used to store modified channels back into their source cues or to add new channels to cues. Update is not routed through channel or filter selections.

### Upfade Time

A timing value associated with channel intensity settings. The up fade time affects the intensity transition in the event the transition is in an upward direction.

### Venue

A representation of your venue or stage production as defined by 3D modeling parameters.

### Wait Time

A timing attribute that can be applied to a cue, causing the next event to be automatically executed after the wait time has elapsed. The wait time begins counting from the moment the cue is executed. (The next event being either the next sequence cue, a linked cue, or a linked macro.)

### Wave Time

The time it will take an effect to loop back to the beginning. A wave time can only be greater than the total sequence time (i.e., the wave time will never cut a sequence short, only add a gap before the sequence starts again).

### Zero

An intensity state of zero ("hard zero", 0% level). A luminaire that is *zero* will only store intensity data, which is stored as a "hard zero" (0% level) along with the luminaire's intensity down time. When a cue is recalled, a zero luminaire will fade out with the luminaire's intensity down time. It will not change any other parameter positions because there is no data stored for them.



**B.**

# INDEX



## Index

### Numerics

- 276 Display 14, 369, 370
- 2D Display
  - unit of measure 310
- 3D encoder 66
- 3D graphic
  - camera angle 209
  - display filter 325
  - fan 72
  - importing venue 321
  - location 30, 323
  - modes 326
  - new venue 320
  - orientation 30, 324
  - overview 320
  - quick keys 209
  - unit of measure 310
  - venue size 320
  - window 325, 326
  - window settings 327
  - x/y control 328

### A

- ACN
  - streaming 27
- Action
  - effect 179, 181
- Active intensity 140
- Ad hoc groups
  - overview 136
- Ad-hoc group 136
- Art-Net
  - DMX output 27
  - external fader control 304, 307
- ASCII show file
  - importing 339
- At function key 207
- Autoload
  - effect 190
  - submaster 267, 361

### B

- Background state 175, 177
- Beam
  - copy data 205
  - copy/move 203
  - data window 128, 129, 205
  - encoder 65
  - filters 125
  - overview 125
  - palette 125, 126, 127
  - setting from keypad 76
  - storing and recalling 126, 127
  - with function filter 95

- Black out 254
- Board control disable
  - submaster 290
- Board cue
  - connecting external trigger 353
  - deleting 246
  - overview 243
  - recalling 246
  - recording 245, 246
  - window 247, 248
- Brightness level
  - front panel and monitors 11
  - keyboard 11
- Bump
  - add/solo 284, 285
  - go fader 284, 285
  - intensity 284
  - submaster 284

### C

- Century Palette window 114
- Channel
  - copy/move 203
  - DMX test 348
  - patch 26, 28
  - selecting from Channel Select panel 50, 51, 52
  - selecting from keypad 56
  - selecting from window 53, 54, 55
  - selection using Next/Last 57, 64
  - status mimic 51
  - submaster filter 297
- Channel Select panel
  - operation 50, 51, 52
- Choose, submaster 280
- Clear status errors 349
- Color
  - copy data 205
  - copy/move 203
  - data window 123, 124, 205
  - encoder 65
  - filter store setting 105, 307, 310
  - overview 121
  - palette 121, 122
  - setting from keypad 76
  - storing and recalling 122
  - with function filter 95
- Command-Line
  - See also Keypad
- Configuration, system
  - clear 22
  - console name 21
  - overview 20
  - store 22
  - update 23
- Console
  - backup 313
  - log 10, 341, 349
  - name 20





- power down 7
- power up 6
- restart front panel 6
- shut down all 7
- shut down front panel 7
- software 6
- system configuration 20

Console, V276 On Mac

- special considerations 14

Console, V476

- encoder sidebar 12, 69
- external monitor workspace 13
- front panel 12
- workspace swapping 12

Copy/Move

- channel 203
- data 204
- effect 178
- function key 208
- palette data 203
- submaster 303

Copy/Paste

- soft keyboard 112, 142

Cue

- affect of faders on 254, 262, 300, 301
- as an effect 196
- copy/move 203
- creating cue numbers without storing 256
- cue sheet 265
- data display area 145
- data window 268, 269, 270
- definition 140
- deleting 144
- editing 270, 271
- forward/back buttons 265
- freeze state 257, 293
- global time 252
- import 335
- label shortcuts 143
- labeling 142
- linking 250, 303
- links 265
- locate stored 257
- looping 251
- modifying 144
- out time 253
- playback 146, 302
- renumbering 266
- resync 263
- setting intensity state 141
- snapshot indicator 267
- snapshot list 232
- special attributes 250
- storing 140, 141, 299
- submaster autoload 267
- submaster stop/step 267
- submaster track mode 263, 266, 303
- target 256
- time 265
- track/fill 259

- updating 258, 303
- wait time 251, 303
- with function filter 95

Cue Data window

- customizing 269, 270
- editing 270, 271
- find/replace 271
- overview 268
- settings 269

Cue sheet

- separator 266

Cue stack

- See also Stack

Curve, lamp 30, 35

## D

Date/Time stamp 306, 310

Delay 90

- timing 89

Delay/3D

- encoder 66

Delete function key 207

Diagnostics

- dimmer check 348, 349
- DMX512 channel 348

Dimmer check 348, 349

Dimmer curves 33, 35, 36

Direct mode

- submaster 263, 303

Direction

- effect 179

Display filter

- 3D 325
- automatic 312
- loading and clearing 311

DMX fixture

- channel test 348
- Setup window 348

DMX512

- defining universes 27
- offset 30
- patch fixture 29
- profile 26, 104
- universe 27, 30

Douse

- lamp 51, 54, 58

Duration

- effect 179, 182

Dynamic disable

- submaster 291

Dynamics

- canned 153, 154, 155
- clipping 158
- copy/move 203
- custom 165, 166
- data window 167
- disable 291
- encoders 67, 151



- fan offset 159
- guidelines 152
- offset 67, 157
- overview 150, 152
- playback 155, 166
- point-to-point 163
- randomize 156
- rate 67, 157, 158
- size 67, 157, 158
- store DynOnly 161
- storing 152
- storing and recalling 167
- storing as a macro 159, 160
- storing as cues or presets 159, 160
- super palette 151
- warning messages 158

## E

### Effect

- action 179, 181
- assigning timing 186, 187, 188
- attack time 186
- background state 175, 177
- break mode 180
- cascade start 181
- changing attributes 182
- continous mode 180
- copy/move 203
- creating basic 174
- cycle mode 180
- cycles duration 182, 183
- decay time 186
- direction 179
- duration 179, 182
- duration time 183, 184
- editing 178
- encoder 68
- encoders 171
- fade in 183, 186
- fade out 183, 186
- forward direction 179
- from command line 195
- group as set 194
- keypad shortcuts 178
- load 189
- mode 179, 180
- N/A duration 182
- null state 177
- oscillate 179
- overview 138, 170
- palette 172
- part 192, 194
- playback 189, 190
- random 179
- reverse direction 179
- run action 181
- sequence 193, 194
- sequence timing 185
- set 192, 194

- Set 0 172
- simultaneous 181
- simultaneous start 181
- start 179, 181
- step 193, 194
- step time 184, 186
- stop action 181
- stop flag 191
- storing as cue 196
- super palette 136, 171, 174
- sustain time 186
- tap-sync step time 188
- time duration 182
- timing 183, 184
- timing duration 183
- utility menu 196
- wave time 183
- zero state fade 184

Emergency action 306, 310

### Encoder

- 3D 66
- beam 65
- color 65
- dynamics 67, 151
- effect 68, 171, 186, 187
- fan 60, 66, 71, 72, 92
- frame 67
- high resolution mode 73
- HUD 365, 367
- image 66
- intensity 64, 141
- min/max settings 68, 70
- overview 60, 61
- pan/tilt 64
- range 63
- rate 288
- shift with effect 186
- sliding sidebar 12, 69, 100
- value 63
- value/percent 100
- window 70

Erase Luminaire Data 59

### Ethernet

- configuration 24

### Export

- patch 340

## F

### Fader

- affect on intensity 254
- flying 306
- grand master 254
- intensity 141
- submaster 254

### Fan

- delay 66
- setting 71
- time 66
- types 60, 66, 71, 72

- with dynamics 156
- Flip
  - pan/tilt 64
- Focus
  - pan/tilt 30
  - reverse 30
  - swap 30
- Frame
  - encoder 67
- Freeze
  - submaster 292
- Function filter
  - applying to beams 95, 125
  - applying to colors 95
  - applying to cues 95
  - applying to submaster 95
  - general operations 87
  - overview 86
  - setting filters 95
  - sneak 3D 99
  - submaster 298
  - templates 87, 101
- Function keys
  - overview 206
  - quick keys 209
  - using 206, 207

## G

- Global cue time 252
- Gobo
  - image encoder 66
- Grand master 254
- Group
  - ad-hoc 132, 136, 137
  - advanced operations 132
  - allocation 136
  - arrangement 132, 133, 135
  - as effect set 194
  - automatic 135
  - channels 132, 133, 134
  - copy/move 203
  - direction 136
  - divisions 135
  - layout 136
  - manual 135
  - next/last 57
  - none 133, 134
  - order 131, 135
  - overview 130
  - palette 130
  - rules 133, 134
  - saving changes 133
  - stored 133, 134
  - storing and recalling 130, 131
  - super palette 132, 133, 134, 135, 136, 137

## H

- High resolution, encoder 73
- Highest Takes Precedence
  - concept of 301
- Highlight 64, 202, 309
- Home 51, 54, 59
- Host 27
- HUD
  - Command 365, 366
  - Encoders 365, 367
  - Submasters 365, 368
  - V276 14, 369, 370

## I

- Image
  - encoder 66
- Import
  - 3D venue 321
  - all 335
  - cues 335
  - dimmer curves 36
  - fixture type conversion 334
  - palette data 336
  - patch 340
  - selective 334, 335
  - show data 334, 339
  - venue 321
- Independent
  - submaster 294
- Inhibitive
  - submaster 293
- Intensity
  - active 140
  - bump 284
  - encoder 64, 141
  - faders 141
  - HTP 301
  - in playback 299
  - marked 140, 303
  - out 140, 303
  - setting from keypad 77
  - states 140, 141, 299
  - transitions 301
  - window 83, 84
  - with manual assign 296
  - zero 140, 303
- Interlaced 176

## K

- Keypad
  - arrows setting 306
  - guidelines 75
  - overview 74
  - setting intensity from 77
  - setting parameters from 76, 77
  - setting parameters from 76
  - shortcuts

## L

### Label

- copy/paste 112, 142
- cue 142
- palette 112
- shortcut 113, 143

### Lamp

- douse 51, 54, 58
- start 51, 54, 58

### Last

- with channel selection 64

### Layout Settings window, Plan View 40

### LED fixture

- patch 31

### Libraries

- dimmer curves 35, 36

### Link 250

- controlling during playback 303

### Live mode 10, 329

### Location

- defining X, Y, Z 30, 323

### Log

- clearing 341, 349
- console 10, 341, 349

### Loop 251

### Lowlight 309

### Luminaire Status window

- customizing 80
- data types 79
- overview 78, 79
- parameter columns 82
- selecting channels from 81

## M

### Macro

- canned 238, 239
- copy/move 203
- data window 236
- overview 138, 233
- palette 233, 234, 238
- recalling 238
- recording 233, 234

### Manual assign

- submaster 295, 296

### Manual control

- 3D/delay 66
- 3D/time 66
- ad-hoc groups 136
- beam 65
- color 65
- dynamics 67, 153
- effect 68
- fan 60, 66, 71, 92
- frame 67
- image 66
- intensity 64
- pan/tilt 64
- shutter 67

### soft encoders 60, 61

### timing 198

### Manual timing

#### using 198

### Marked intensity 140, 303

### Masking 93, 94

### Media palette

- library 217
- overview 213, 214
- playmodes 218
- server control 218
- super palette 215, 216
- thumbnails 216, 217
- view lock 217

### Media Server Setup window 210, 211, 212

### Media servers

- controlling 73, 210
- library 213
- Media palette 213, 214, 215, 216, 217, 218
- Media Setup 219
- Server Setup window 210, 211, 212

### Media Setup Legacy window 219

### MIDI

- channel 308
- input options 352
- input/output port 308
- message format 308, 362
- notes 354
- overview 352
- show control 359, 362
- synchronizing 355
- timecode autoswitch 310
- timecode editing 356
- timecode overview 355
- timecode recording 356
- with board cues 243

### Min/Max settings

- soft encoder 68

### Mode

- effect 179, 180
- indicator 329
- live 10, 329
- Live/Preview indicator 10
- preview 10, 329
- submaster 280

### MSC commands 360

### Multi-console

- backup 313
- channel partition 315
- configuring 314
- primary 313
- secondary 313

## N

### Naming

- console 21

### Next/Last

- with channel selection 57, 64

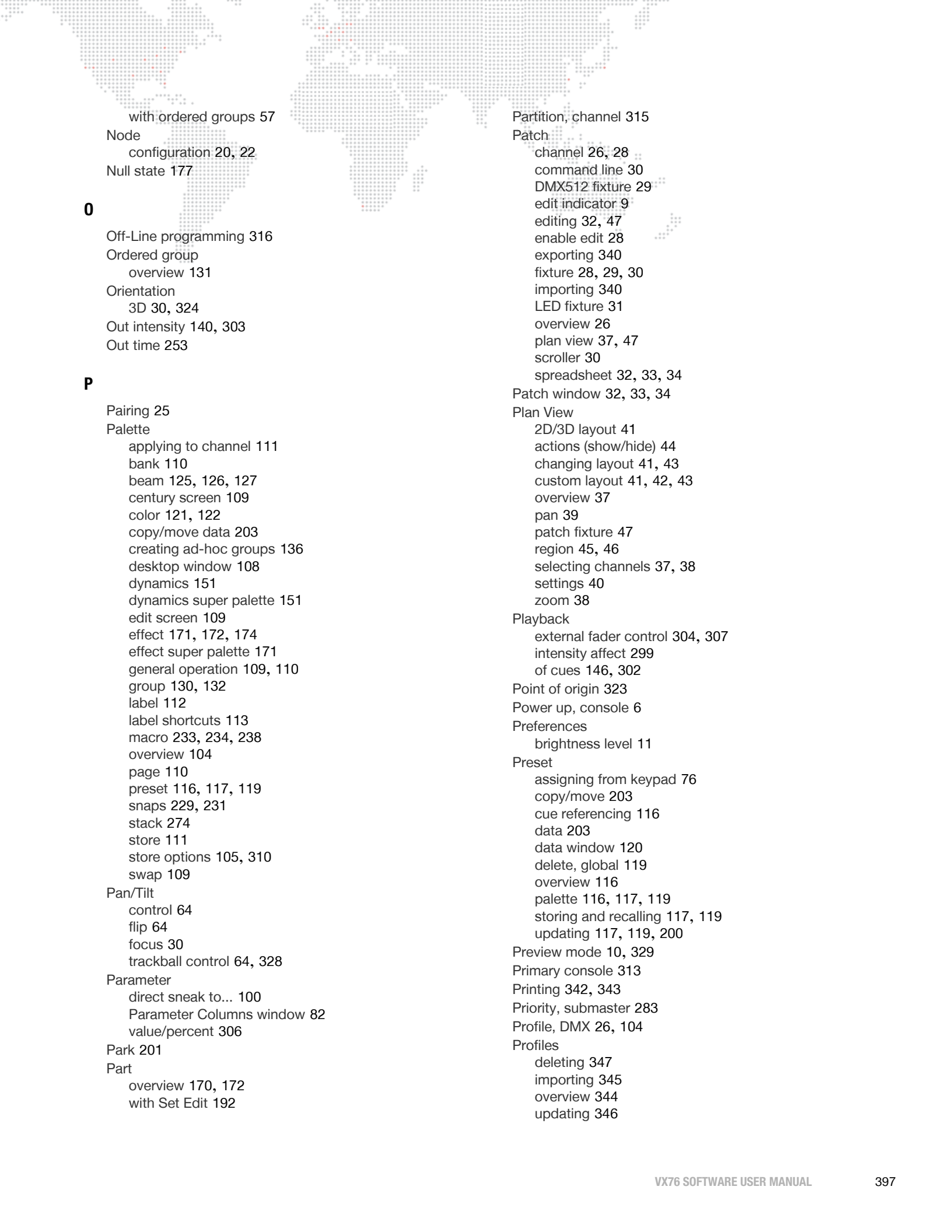

with ordered groups 57  
Node  
  configuration 20, 22  
Null state 177

**O**

Off-Line programming 316  
Ordered group  
  overview 131  
Orientation  
  3D 30, 324  
Out intensity 140, 303  
Out time 253

**P**

Pairing 25  
Palette  
  applying to channel 111  
  bank 110  
  beam 125, 126, 127  
  century screen 109  
  color 121, 122  
  copy/move data 203  
  creating ad-hoc groups 136  
  desktop window 108  
  dynamics 151  
  dynamics super palette 151  
  edit screen 109  
  effect 171, 172, 174  
  effect super palette 171  
  general operation 109, 110  
  group 130, 132  
  label 112  
  label shortcuts 113  
  macro 233, 234, 238  
  overview 104  
  page 110  
  preset 116, 117, 119  
  snaps 229, 231  
  stack 274  
  store 111  
  store options 105, 310  
  swap 109  
Pan/Tilt  
  control 64  
  flip 64  
  focus 30  
  trackball control 64, 328  
Parameter  
  direct sneak to... 100  
  Parameter Columns window 82  
  value/percent 306  
Park 201  
Part  
  overview 170, 172  
  with Set Edit 192

Partition, channel 315  
Patch  
  channel 26, 28  
  command line 30  
  DMX512 fixture 29  
  edit indicator 9  
  editing 32, 47  
  enable edit 28  
  exporting 340  
  fixture 28, 29, 30  
  importing 340  
  LED fixture 31  
  overview 26  
  plan view 37, 47  
  scroller 30  
  spreadsheet 32, 33, 34  
Patch window 32, 33, 34  
Plan View  
  2D/3D layout 41  
  actions (show/hide) 44  
  changing layout 41, 43  
  custom layout 41, 42, 43  
  overview 37  
  pan 39  
  patch fixture 47  
  region 45, 46  
  selecting channels 37, 38  
  settings 40  
  zoom 38  
Playback  
  external fader control 304, 307  
  intensity affect 299  
  of cues 146, 302  
Point of origin 323  
Power up, console 6  
Preferences  
  brightness level 11  
Preset  
  assigning from keypad 76  
  copy/move 203  
  cue referencing 116  
  data 203  
  data window 120  
  delete, global 119  
  overview 116  
  palette 116, 117, 119  
  storing and recalling 117, 119  
  updating 117, 119, 200  
Preview mode 10, 329  
Primary console 313  
Printing 342, 343  
Priority, submaster 283  
Profile, DMX 26, 104  
Profiles  
  deleting 347  
  importing 345  
  overview 344  
  updating 346



Programming  
off-line 316

## Q

QuickFocus 199, 200, 306  
Quit Vx76 7

## R

Rate  
encoder 287  
submaster 287, 288  
Recalibrate 51, 54, 59  
Reset 51, 54, 59  
Restart  
front panel 6  
Resync  
submaster direct mode 263

## S

Secondary console 313  
Select function key 208  
Selective recall  
function key 207  
using 261  
Selective store  
function key 206  
using 260  
with submasters 262  
Sequence  
attack time 185  
copy/move 203  
creating 175  
decay time 185  
edit 193, 194  
overview 170, 173  
step time 185  
sustain time 185  
timing 185  
Sequential 176  
Set  
copy/move 203  
creating 175  
default set 172  
edit 192, 194  
interlaced 176  
overview 170, 172  
sequential 176  
Set 0 172  
Settings  
actions 306  
DMX In 307  
general 306  
Highlight 309  
live status windows 81  
MIDI 308  
palette 105  
storing 307

window 306, 307, 308, 310

Show file  
archive 334  
delete 17, 333  
duplicate 17, 333  
erase luminaire data 59  
import data 334, 335, 339  
import palette data 336  
indicator 9  
Manager window 17, 338  
open archive 333  
open existing 333  
open new 17, 332  
overview 16, 332  
printing 342, 343  
profiles 344  
rename 17, 333  
save a copy 338  
USITT ASCII 339

Shut down  
front panel 7

Shutter 67

SMPTE  
input options 352  
overview 352  
synchronizing 355  
timecode editing 356  
timecode overview 355  
timecode recording 356

Snapshot  
copy/move 203  
cue effect loading 232  
cues 232  
deleting 231  
filter window 228, 229, 230  
overview 138, 228  
palette 229, 231  
recalling 231  
Snapshot Data window 232  
storing 229, 230  
with cue 231  
with submaster 231

Sneak  
3D 99  
direct to parameters 100  
function key 208  
operation 98  
overview 86, 96  
value/percent 100  
values 97  
X, Y, Z values 99

Software  
entering/editing window data 8  
launch 6  
Mac dock 9  
menus and button bar 8  
quit 7  
status indicator bar 9  
system devices 317  
update 317

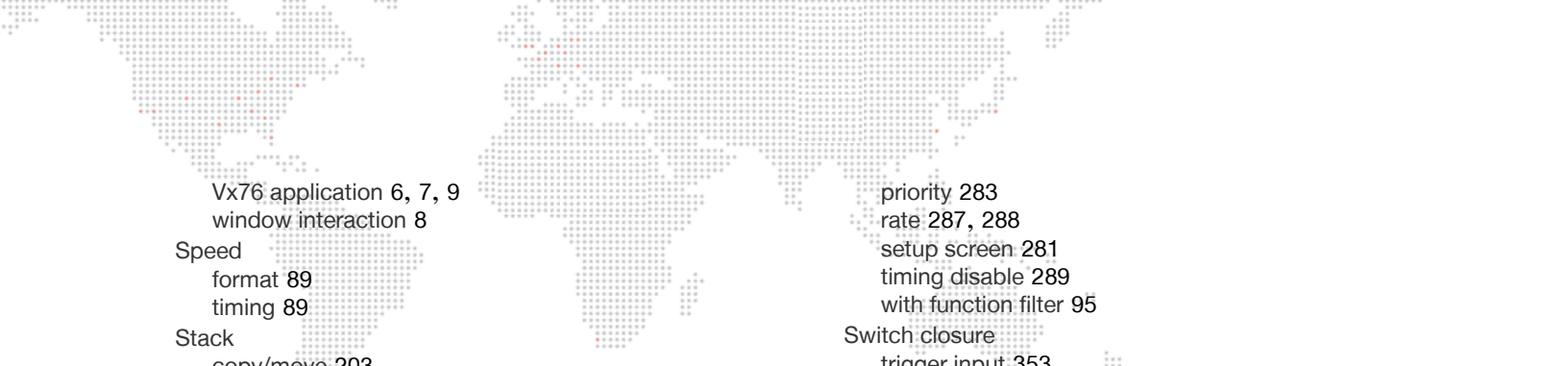

Vx76 application 6, 7, 9  
window interaction 8

Speed  
format 89  
timing 89

Stack  
copy/move 203  
cue sheet 265  
in command line 273  
in Cue Sheet window 275  
overview 273  
palette 274  
with submasters 276

Start  
effect 181  
lamp 51, 54, 58

Startup action 306, 310

Status Columns window 120, 128

Status indicator 9, 10

Status mimic 51, 54

Step  
background state 177  
null state 177  
overview 170, 173  
with Sequence Edit 193

Stop flag  
effect 191

Store function key 206

Submaster  
autoload 361  
board control disable 290  
board cue Go 246, 303  
bump 284  
channel filter 297  
choose 280  
clear 282  
control screen 281  
copy/move 303  
creating ad-hoc groups 136  
cue autoload 267  
cue direct mode 263, 303  
cue stop/step 267  
cue track mode 266  
dynamic disable 291  
effect autoload 190  
external fader control 304, 307  
faders 254, 262, 300, 301  
flying faders 306  
freeze 292  
function filter 298  
HUD 365, 368  
independent 294  
inhibitive 293  
manual assign 295, 296  
modes overview 280  
modifying cues in 262  
overview 278, 281  
playback of cues 146, 302

priority 283  
rate 287, 288  
setup screen 281  
timing disable 289  
with function filter 95

Switch closure  
trigger input 353

System  
configuration 20  
device pairing 25  
Ethernet configuration 24  
node configuration 20, 22  
partition 315  
settings 306, 307, 308, 310

## T

Target, last stored 256

Templates 101

Thumbwheel address 26

Time  
encoder 66  
format 89

Timecode  
autoswitch 306, 310

Timecode scripts  
recording 356  
window 356, 357

Timing  
assigning to effect 186, 187, 188  
delay 90  
effect 183, 184  
function key 208  
manual timing 198  
sequence 185

Timing disable  
submaster 289

Timing filter  
delay 89  
formats 89  
general operations 87  
overview 86, 88  
setting delay 90  
setting speed 90  
setting time 90  
speed 89  
templates 87, 101  
time 89

Touchscreen  
operation 104

Track  
submaster 266

Track/Fill  
function key 207  
operation 259

Trackball  
with pan/tilt 64, 328



## U

- Undo
  - command 144, 261
  - manual changes to cue 262
- Units of measure 306, 310
- Universe
  - Bus 27
  - defining 30
- Unpark 201
- Update
  - function key 206
  - system configuration 23
  - using 258
  - with submasters 262
- Utility menu, effect 196

## V

- V276 On Mac 14, 369
- Venue, 3D
  - importing 321
  - new 320
  - point of origin 323
  - size 320

- Version Info window 21, 314

- Visionary
  - heads up displays (HUDs) 14, 365, 366, 367, 368, 369, 370
  - main window 364
  - overview 364

## W

- Wait time 251
- Windows
  - entering/editing data 8
  - interaction 8
- Workspace
  - swapping on V476 12, 13

## X

- X,Y,Z
  - 3D location 30, 323
- X/Y control 328

## Z

- Zero intensity 140, 303





Vx76 Software User Manual  
Version as of: March 22, 2013  
PRG part number: 02.9814.0001.36



Production Resource Group, LLC  
Dallas Office  
8617 Ambassador Row, Suite 120  
Dallas, Texas 75247  
[www.prg.com](http://www.prg.com)